

 **BD** FACSymphony™ S6 Cell Sorter
User's Guide

Copyrights

No part of this publication may be reproduced, transmitted, transcribed, stored in retrieval systems, or translated into any language or computer language, in any form or by any means: electronic, mechanical, magnetic, optical, chemical, manual, or otherwise, without prior written permission from BD.

The information in this guide is subject to change without notice. BD reserves the right to change its products and services at any time. Although this guide has been prepared with every precaution to ensure accuracy, BD assumes no liability for any errors or omissions, nor for any damages resulting from the application or use of this information. BD welcomes customer input on corrections and suggestions for improvement.

Trademarks

BD, the BD Logo, BD FACSClean, BD FACSDiva, BD FACSFlow, BD FACSRinse, BD FACSsymphony, BD Trucount, Calibrite and FACS are trademarks of Becton, Dickinson and Company or its affiliates. All other trademarks are the property of their respective owners. © 2022 BD. All rights reserved.

Cy™ is a trademark of GE Healthcare. Cy™ dyes are subject to proprietary rights of GE Healthcare and Carnegie Mellon University, and are made and sold under license from GE Healthcare only for research and in vitro diagnostic use. Any other use requires a commercial sublicense from GE Healthcare, 800 Centennial Avenue, Piscataway, NJ 08855-1327, USA.

Regulatory information

For Research Use Only. Not for use in diagnostic or therapeutic procedures.

Laser safety information

Class 1 Laser Product.

FCC information

WARNING: Changes or modifications to this unit not expressly approved by the party responsible for compliance could void the user's authority to operate the equipment.

NOTICE: This equipment has been tested and found to comply with the limits for a Class A digital device, pursuant to Part 15 of the FCC Rules. These limits are designed to provide reasonable protection against harmful interference when the equipment is operated in a commercial environment. This equipment generates, uses, and can radiate radio frequency energy and, if not installed and used in accordance with the instruction manual, may cause harmful interference to radio communications. Operation of this equipment in a residential area is likely to cause harmful interference in which case the user will be required to correct the interference at his or her own expense. Shielded cables must be used with this unit to ensure compliance with the Class A FCC limits. This Class A digital apparatus meets all requirements of the Canadian Interference-Causing Equipment Regulations. Cet appareil numérique de la classe A respecte toutes les exigences du Règlement sur le matériel brouilleur du Canada.

History

Revision	Date	Change made
23-20080-00	2018-10	Initial release
23-20080-01	2020-03	Updates to 6-way sorting and troubleshooting. Specific features added to Symphony S6
23-20080-02	2020-10	Removed references to BD FACSRinse™ and added BD® Detergent Solution Concentrate in place of BD FACSRinse™.
23-20080(03)	2021-07	Added waste tank baffle, amber collection devices, laser shutter, sort collection hanger, assignment of multiple fluorochromes to a channel, error message in the troubleshooting section, and CST page.
23-20080(04)	2022-07	Added 6-way 1.5 mL tube holder option. Added support for USB digital cameras. Added sort conflict support for 6-tube sort layouts. Updated part numbers for BD FACSDiva™ CS&T Research Beads.

Contents

1 About this guide	7
Conventions	8
Technical assistance	9
Limitations	9
2 System components	11
BD FACSymphony™ S6 Cell Sorter system	12
Workstation	12
Biosafety cabinet	13
Flow cytometer	13
Emergency stop button	31
3 Theory of operation	33
Fluid movement	34
Signal generation	36
Signal detection	37
Sorting	43
4 Using BD FACSDiva™ software	55
Workspace components	56
Cytometer controls	56
Sorting controls	69
Reference line setup for digital cameras	77
Sort alignment software for analog cameras	80
Templates	85
5 Startup and running samples	87
Cytometer startup	88
Checking cytometer performance	99
Application settings	103
Data collection	108

Data recording and analysis	111
Manual adjustment of laser delay	116
6 Sorting	119
Setting up for sorting	120
Determining the drop delay – manual method	123
Determining the drop delay – automatic method	126
Sorting	127
Setting up for sorting onto a plate or slide	132
Index sorting	136
Terasaki plate adapter	138
7 Shutdown and maintenance	139
Daily shutdown	140
Scheduled maintenance	144
Unscheduled maintenance	155
8 Troubleshooting	169
Troubleshooting the stream	170
Troubleshooting the breakoff	173
Sorting troubleshooting	174
Acquisition troubleshooting	177
Fluidics troubleshooting	181
Electronics troubleshooting	182
9 Supplies and consumables	183
Cytometer supplies	184
Consumables	188
10 BD® Aerosol Management Option	191
Option components	192
Operating the BD® Aerosol Management Option	193
Maintenance	196
Upgrades for the AMO	200
Troubleshooting the AMO	201
Specifications	203
11 Biosafety Cabinet Option	205
Biosafety cabinet overview	206
Aerosol Management System	210
Operating the AMS	211
Working in the BSC	213
Cleaning the base pan	214
Replacing the electronics cable plastic sleeve	216

12 BD FACSymphony™ S6 Temperature Control Option	217
Option components	218
Using the BD FACSymphony™ S6 Temperature Control Option	219
Maintenance	222
Specifications	223
Index	225

This page intentionally left blank

1

About this guide

This user guide contains the instructions necessary to operate and maintain your BD[®] FACSymphony™ S6 cell sorter. Because many instrument functions are controlled by BD FACSDiva™ software, this guide also contains basic software information needed for instrument setup. For detailed information on software functions, see the *BD FACSDiva Software Reference Manual*.

This user guide assumes you have a working knowledge of basic Microsoft[®] Windows[®] operation. If you are not familiar with the Windows operating system, see the documentation provided with your computer.





Before using the BD FACSymphony™ S6 cell sorter for the first time, review the following information:

- [System components \(page 11\)](#) to become familiar with system components
- [Theory of operation \(page 33\)](#) to understand how the instrument works and to learn about the software components used to control different subsystems
- [Using BD FACSDiva™ software \(page 55\)](#) to see where software controls are located

Instructions for routine acquisition, analysis, and sorting can be found in Chapters 4 and 5.

Conventions

The following tables list conventions used throughout this guide. The first of the following tables list the symbols that are used in this guide or on safety labels to alert you to a potential hazard. Text and keyboard conventions are shown in the second table.

Symbol ¹	Meaning
	Caution: hazard or unsafe practice that could result in material damage, data loss, minor or severe injury, or death
	Electrical danger
	Laser radiation
	Biological risk
	Pinch hazard

¹ Although these symbols appear in color on the instrument, they may be in black and white throughout the printed user guide; their meaning remains unchanged.

Technical assistance

For technical questions or assistance in solving a problem:

- Read the section of the user guide specific to the operation you are performing.
- See [Troubleshooting \(page 169\)](#)

If additional assistance is required, contact your local BD Biosciences technical support representative or supplier. Visit our website, bdbiosciences.com, for up-to-date contact information.

When contacting BD Biosciences, have the following information available:

- Product name, part number, and serial number
- Any error messages
- Details of recent system performance

Limitations

This instrument is for Research Use Only. Not for use in diagnostic or therapeutic procedures.

BD Biosciences is providing software without warranty of any kind on an as-is basis. The software and workstations are intended for running the instruments supplied by BD Biosciences. It is the responsibility of the buyer/user to ensure that all added electronic files including software and transport media are virus-free. If the workstation is used for internet access or purposes other than those specified by BD Biosciences, it is the buyer/user's responsibility to install and maintain up-to-date virus protection software. BD Biosciences does not make any warranty with respect to the workstation remaining virus-free after installation. BD Biosciences is not liable for any claims related to or resulting from the buyer/user's failure to install and maintain virus protection.

This page intentionally left blank

2

System components

The following topics are covered in this chapter:

- [BD FACSymphony™ S6 Cell Sorter system \(page 12\)](#)
- [Workstation \(page 12\)](#)
- [Biosafety cabinet \(page 13\)](#)
- [Flow cytometer \(page 13\)](#)
- [Emergency stop button \(page 31\)](#)

BD FACSymphony™ S6 Cell Sorter system

The BD FACSymphony™ S6 cell sorter is a high-speed fixed-alignment benchtop cell sorter. With its fixed-optics design and digital electronics, the BD FACSymphony™ S6 cell sorter enables multicolor analysis of up to 60 parameters, including two scatter parameters.

The system consists of three main components: the BD FACSymphony™ S6 cell sorter, the optional Biosafety Cabinet (BSC), and the workstation, as shown in the following figure.



Workstation

Data acquisition and analysis, as well as most BD FACSymphony™ S6 cell sorter functions, are controlled by BD FACSDiva™ software on a PC workstation. The workstation is equipped with the following applications:

- Microsoft® Windows® operating system
- BD FACSDiva™ software, version 9.5 or later
 - Data acquisition and analysis
 - Automatic fluidics startup, shutdown, and cleaning modes
 - Sort setup, stream monitoring, clog detection, and recovery
 - BD® Cytometer Setup and Tracking (CS&T) module for setup and tracking performance
- Supporting documentation for the software

For information about software features specific to the BD FACSymphony™ S6 cell sorter, see [Theory of operation \(page 33\)](#) and [Using BD FACSDiva™ software \(page 55\)](#). For general software information, see the BD FACSDiva™ Software Reference Manual.

BD FACSDiva™ software includes a BD® CS&T Research Beads module. For information on running the BD® CS&T Research Beads module with the BD FACSymphony™ S6 cell sorter, see [Checking cytometer performance \(page 99\)](#). For information about the BD® CS&T Research Beads module, see the *BD® Cytometer Setup and Tracking Application Guide*.

Note: For easy access to the online *BD FACSDiva™ Software Reference Manual*, select **Help > Documentation > Reference Manual**.

Biosafety cabinet

The optional BSC for the BD FACSymphony™ S6 cell sorter has been verified to meet personnel and product protection standards for a Class II Type A2 biosafety cabinet, the National Sanitation Foundation International Standard 49, and the Australian Standard® AS 2252.2–2009. The BSC is suitable for work with Biosafety Level (BSL) 1, 2, and 3 (low to moderate risk) infectious agents.

The BSC has an integrated Aerosol Management System (AMS). See [Aerosol Management System \(page 210\)](#) for information.

Flow cytometer

The BD FACSymphony™ S6 cell sorter consists of three subsystems (fluidics, optics, and electronics). The cytometer requires only a 20-A electrical outlet and an in-house air source (or optional compressor) for the fluidics. The following figure shows a view of the BD FACSymphony™ S6 cell sorter without the optional BSC.



See the following sections for more information on each subsystem:

- [Fluidics system \(page 14\)](#)
- [Optics system \(page 25\)](#)
- [Cytometer electronics \(page 29\)](#)

Fluidics system

The fluidics system supplies sheath and cleaning fluids, and collects waste from the cytometer. The contents of the fluidics drawer and the fluidics components located inside the cytometer make up the fluidics system.

Fluidics drawer

The fluid containers, lines, and filters, and the connectors panel are located inside the fluidics drawer. The fluidics drawer slides out for easy access to its contents. Press down the yellow lever on the top right side of the drawer to release the lock and slide the drawer out or in.



Containers

The fluidics drawer holds a 10-L stainless steel sheath tank, a 5-L stainless steel ethanol shutdown tank, a 10-L waste container, and three 5-L auxiliary cleaning fluid containers.

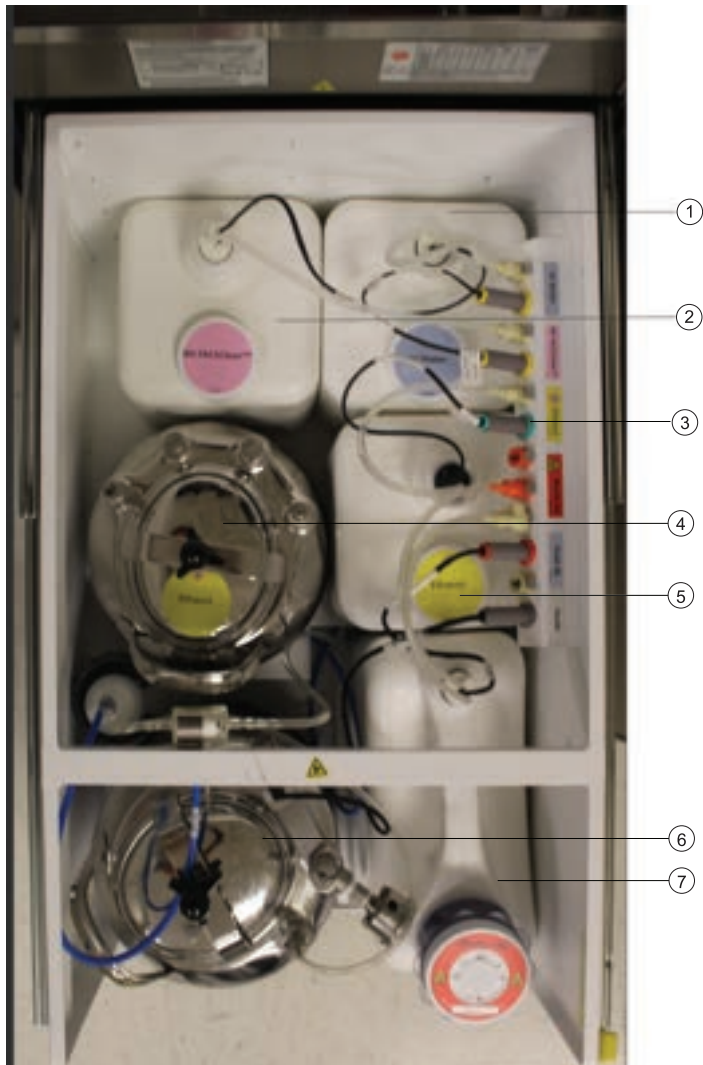

Item number	Component
1	DI water tank
2	BD FACSClean™ solution tank
3	Connector panel
4	Ethanol shutdown tank
5	Ethanol tank
6	Sheath tank with pressure gauge
7	Waste tank

Pressure gauge

A pressure gauge is located on the sheath fluid tank to confirm that the tank is pressurized.

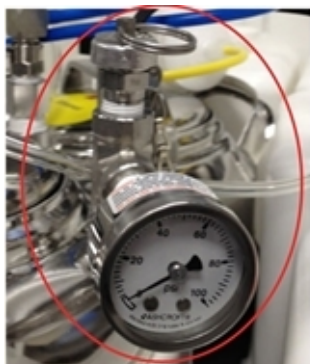

Fluid filters

The fluid filters for DI water, BD FACSClean™ cleaning solution, and ethanol are located in the outside left panel of the fluidics drawer.



Connectors panel

The connectors panel is located in the top right section of the fluidics drawer. A fluid line and a sensor connect each container to the panel.

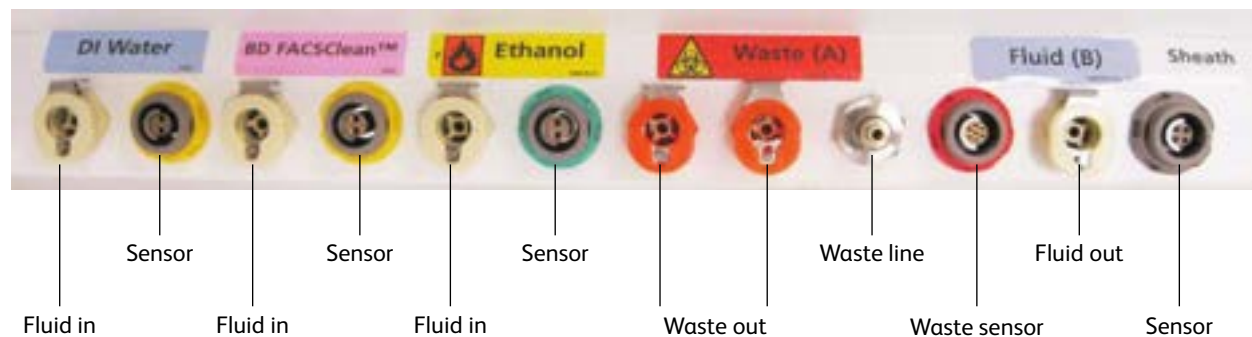

Fluidics components

When the fluidics system is activated, the sheath fluid from the pressurized sheath tank is forced from the fluidics drawer up into the cuvette flow cell where hydrodynamic focusing forces particles from the sample injection chamber through the cuvette in a single-file stream.

Within the cuvette flow cell, laser light is focused on the sample core stream. Fluorescent molecules excited by the different laser wavelengths are detected by the optics and analyzed by the electronics. Particles are then either transported to waste reservoirs via the waste aspirator, or sorted into a collection device within the sort collection chamber.

The following fluidics components are described in this section. For more information about fluidics, see [Fluid movement \(page 34\)](#).

- [Sample injection chamber \(page 17\)](#)
- [Tube holders \(page 18\)](#)
- [Cuvette flow cell \(page 19\)](#)
- [Integrated nozzle \(page 19\)](#)
- [Sort block \(page 20\)](#)
- [Sort collection devices for 2- and 4-way sorting \(page 22\)](#)

Sample injection chamber

The sample injection chamber is where sample is introduced into the flow cytometer. During acquisition, the chamber is pressurized to force sample toward the cuvette flow cell.

Samples can be agitated and temperature-controlled within the sample injection chamber using controls in the software (see [Fluidics controls \(page 56\)](#)). You can view the amount of fluid remaining in your sample tube by pressing the chamber light button shown in the following figure.



Do not use the chamber light for long periods with samples stained with light-sensitive reagents.

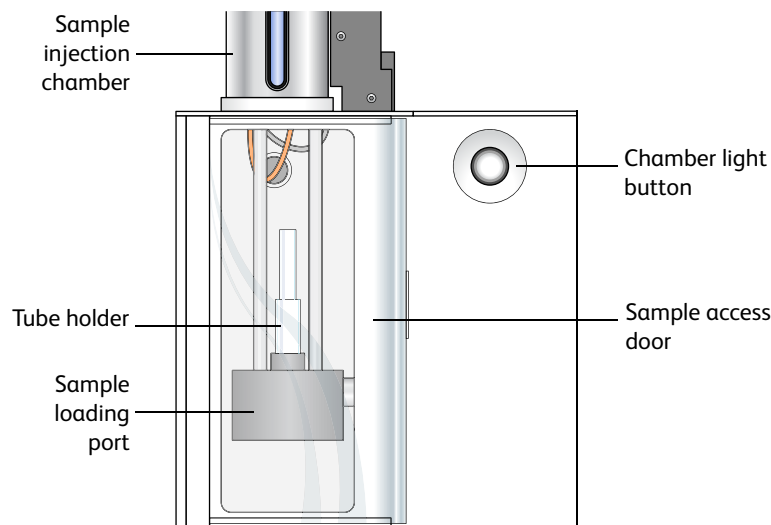

Bubble detector

The bubble detector is an optical sensor that detects air bubbles from the sample tube. Located on the sample line just before the pinch valve, it triggers the pinch valve to close, cutting off sample flow and preventing bubbles from entering the flow cell. When a bubble is detected, the bulk injection chamber light and LED in the button blink to alert the operator.



Tube holders

A variety of tube holders are provided with the cytometer to accommodate tubes from 15-mL centrifuge tubes to 1.0-mL microtubes.

To load a tube, install the appropriate-size tube holder onto the loading port, and place a tube in the holder. Make sure to press the tube holder down firmly onto the metal rod in the loading port, so the tube holder is seated correctly each time a tube is installed.

When the Load button is clicked in the software (see [Acquisition controls \(page 68\)](#)), the loading port rises to enclose the tube within the chamber. The chamber is then pressurized so that sample will flow to the flow cell.

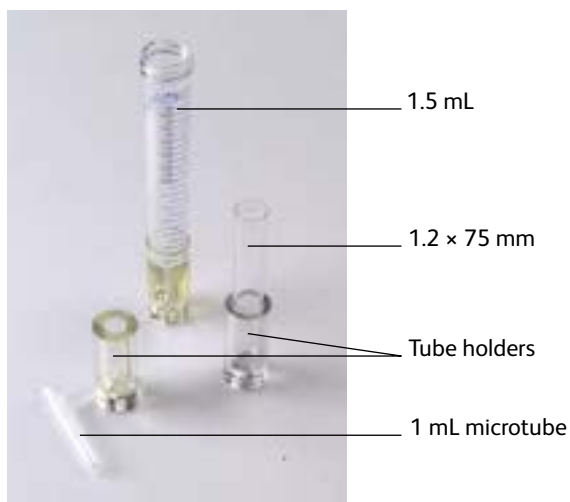

After a tube is loaded, the Load button changes to Unload. Click the Unload button to lower the loading port after data has been recorded. After each tube is unloaded, sheath fluid flushes the sample tubing inside and out to reduce potential sample carryover.



To prevent injury from moving parts, keep your hands and clothing away from the loading port when a tube is loading or unloading. Do not place objects under the loading port.

Cuvette flow cell

The BD FACSymphony™ S6 cell sorter system includes a next-generation flow cell. The cuvette flow cell is the heart of the BD FACSymphony™ S6 cell sorter. Within the flow cell, hydrodynamic focusing forces particles through the cuvette in a single-file stream, where laser light intercepts the stream at the sample interrogation point.

As a precautionary measure, prior to opening the Flow Cell access door, use the **Stop** button in the laser control software to put the lasers in standby and then close the laser control software. This will turn off the laser diode, but will keep the diode temperature constant.

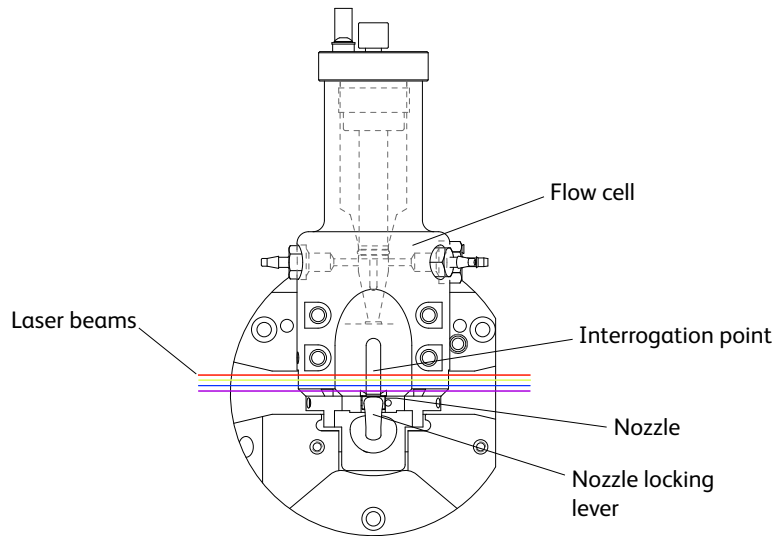

The unique flow cell design permits particles to flow through the cuvette at a low velocity (approximately 6 meters per second for the 70-micron sort setup), allowing longer exposure to laser energy. The cuvette is gel-coupled to the fluorescence objective lens to transmit the greatest amount of emitted light from the interrogation point to the collection optics (see [Optics system \(page 25\)](#)). After passing through the cuvette, the stream is accelerated (to approximately 30 meters per second with the 70-micron sort setup) as it enters the nozzle tip, where the drop drive breaks the stream into droplets for sorting.

Integrated nozzle

The BD FACSymphony™ S6 cell sorter next-generation flow cell requires integrated nozzles that have been optimized for it.

The integrated nozzles are available in four sizes (70, 85, 100, and an optional 130 μm) to accommodate a variety of particle sizes, plus a closed-loop nozzle for use in cleaning and shutdown procedures. The nozzle is keyed to a fixed position at the lower end of the cuvette. Because the nozzle is below the interrogation point, optical alignment is not affected when the nozzle is changed.

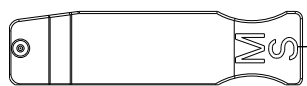

MS indicates integrated nozzle for the BD FACSymphony™ S6 cell sorter flow cell

Bottom view of nozzle

See these sections for more information on the nozzle:

- [Changing the integrated nozzle \(page 155\)](#)
- [Cleaning the integrated nozzle \(page 156\)](#)
- [Handling the integrated nozzle \(page 158\)](#)

Sort block

After leaving the nozzle, particles pass through the sort block where they are either transported to waste via the waste aspirator, or sorted into a collection device in the sort collection chamber. The sort block houses the high-voltage deflection plates, along with the aspirator and aspirator drawer.

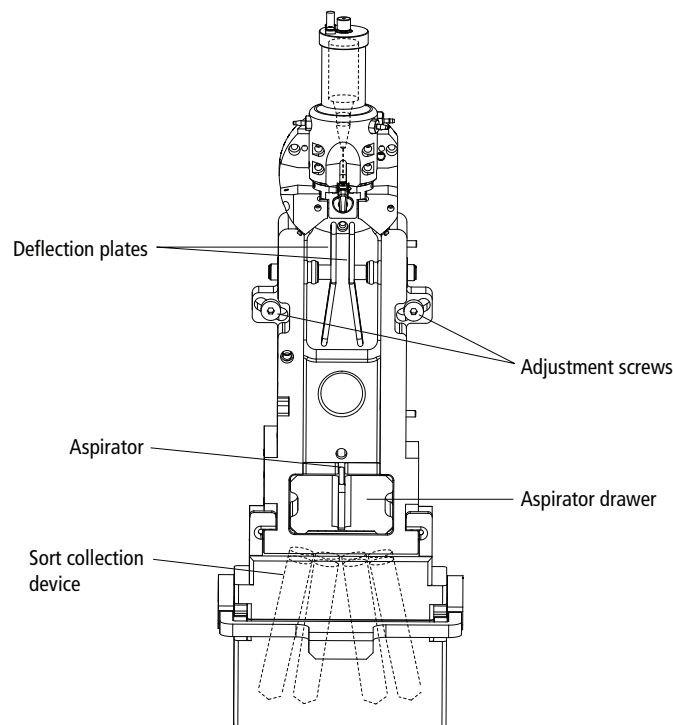

As a precautionary measure, prior to opening the Flow Cell access door, use the **Stop** button in the laser control software to put the lasers in standby and then close the laser control software. This will turn off the laser diode, but will keep the diode temperature constant.

The entire sort block assembly can be rotated on a fixed pivot point to adjust the position of the stream in the waste aspirator. If the keyed stream position differs between different nozzles, the stream might not hit the center of the aspirator after the nozzle is changed. In this case, you can change the angle of the sort block by loosening the adjustment screws on both sides of the deflection plates and rotating the sort block. An Allen wrench is provided in the accessory kit. Tighten the screws when the stream is re-centered in the aspirator.

Deflection plates

The high-voltage deflection plates are used to deflect side streams during sorting. The plates are turned on and off using the Voltage control in the Side Stream window (see [Side Stream Formation \(page 47\)](#)). A red warning light is illuminated whenever the plate voltage is on.



A 12,000-volt potential exists between the deflection plates when they are on. Contact with the charged plates results in serious electrical shock. Do not touch the deflection plates when the voltage warning light is illuminated, or when the software indicates that the plate voltage is on. The plates remain energized even when the sort block door is open.

Aspirator drawer

The aspirator drawer keeps the sort collection tubes covered until sorting begins. You can open and close the drawer using a control in the Sort Layout or Side Stream window (see [Using Sorting Controls \(page 74\)](#)). When the Sweet Spot is on and a clog is detected during sorting, the drawer automatically closes to protect the sort collection tubes. For information on how to handle a clog, see [Sorting \(page 127\)](#).



To avoid pinching your hands or fingers in the drawer, keep your hands away from the sort block during sorting.

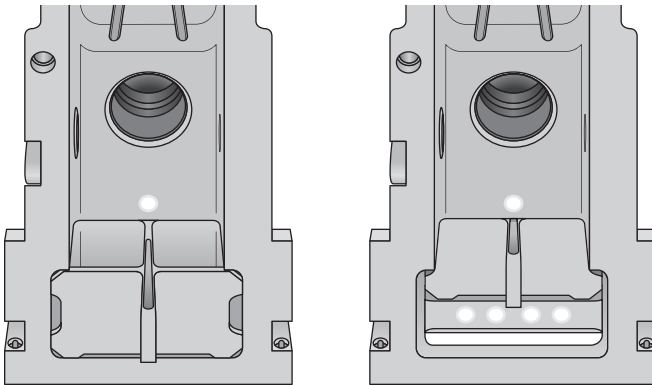

Aerosol management

During sample acquisition and sorting, the sort block door and flow cell access door should be kept closed to help contain potential aerosols.



Cell sorters that use droplet generation methods, such as the BD FACSymphony™ S6 cell sorter, can produce aerosols around the sample stream. When acquiring biohazardous samples, follow universal precautions at all times. Keep the sort block door closed during sorting. If you need to access the sort block and you are working with highly infectious samples, consider turning off the stream before opening the sort block door.

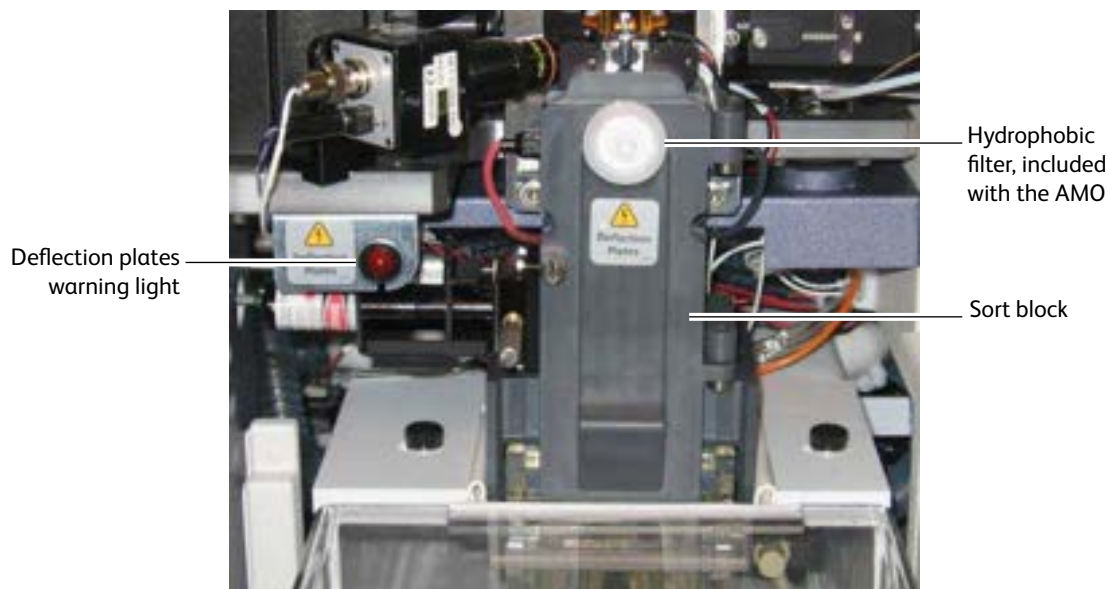

Additional aerosol removal is provided by either the AMS or the BD[®] Aerosol Management Option (AMO).

The AMS is integrated into the BSC and contains a high efficiency particulate air (HEPA) filter. See [Operating the AMS \(page 211\)](#) for instructions.

The AMO is an optional device for systems without a BSC. The AMO evacuates the sort collection chamber during sorting and is equipped with an ultra-low penetrating air (ULPA) filter to trap aerosolized particles. See [BD[®] Aerosol Management Option \(page 191\)](#) for complete information on using this option.

Sort collection devices for 2- and 4-way sorting

Collection devices are installed in the sort collection chamber to collect sorted samples. The collection devices are designed in two pieces with a universal top that can be used with different tube configurations. The universal top has three holes on the back side that help with aerosol evacuation when an AMO or AMS is installed.

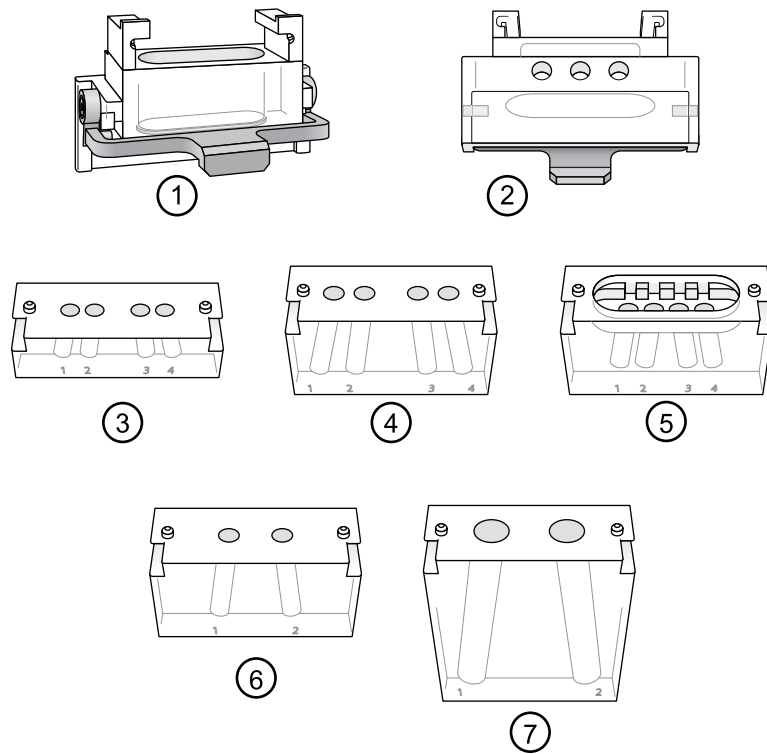

1	Enclosed top (front view)
2	Enclosed top (back view)
3	Four-way 1 mL (optional)
4	Four-way 12 × 75 mm
5	Four-way 1.5 mL Eppendorf
6	Two-way 12 × 75 mm
7	Two-way 15 mL

Sort collection devices for 4- and 6-way sorting

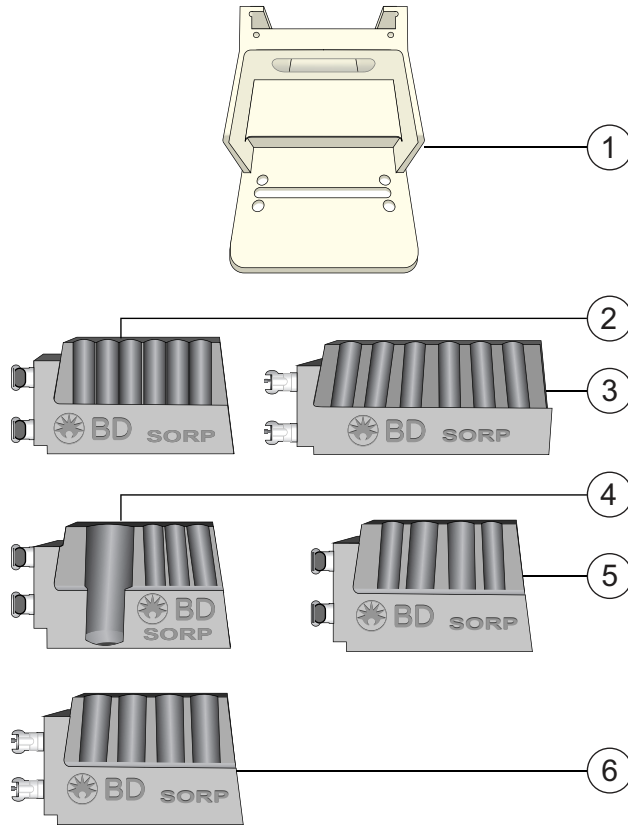

1	Upper tube holder mount
2	6-way 12 × 75 mm
3	6-way 1.5 mL
4	Left: 50 mL; Right: 3-way 12 × 75 mm
5	4-way; Outside: 12 × 75 mm; Inside: 15 mL
6	Four-way 15 mL

A transparent amber 6-way sort collection device with integrated tube holder mount is also available as shown in the following diagram.

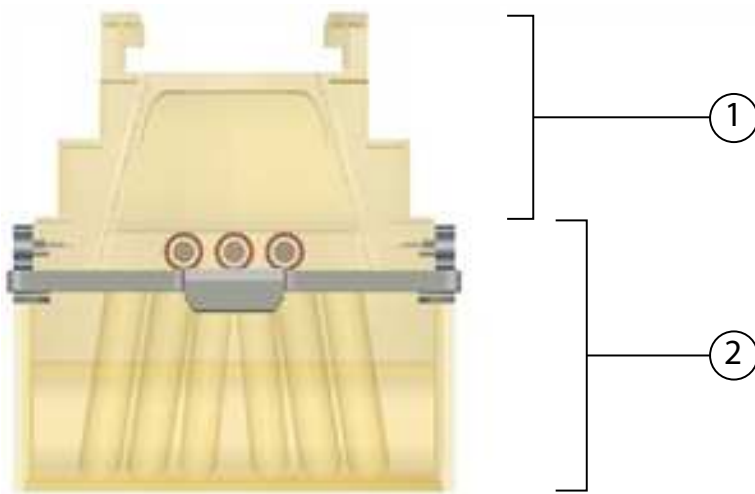

1	6-way 5 mL tube holder top
2	6-way 5 mL amber tube holder

An automated cell deposition unit (ACDU) holds multi-well plates and slides for sort collection. The sort collection chamber door should be kept closed when sorting onto a plate. The door keeps the chamber free of dust and other airborne particles, and seals the chamber during aerosol evacuation for cytometers equipped with the AMO.

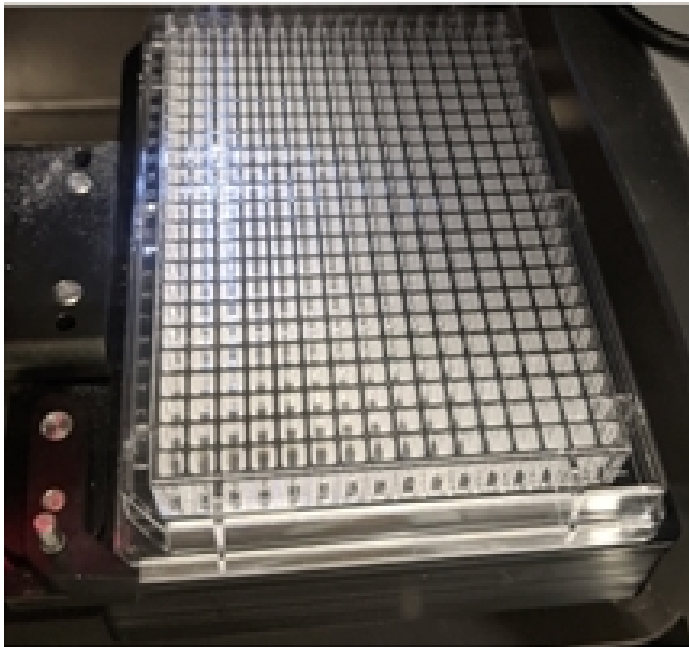

Optics system

The BD FACSymphony™ S6 cell sorter uses innovative designs for both the excitation and collection optics.

Excitation optics

The excitation optics consist of lasers, beam steering optics, and focusing lenses.

For information about how signals are generated, see [Signal generation \(page 36\)](#).

The BD FACSymphony™ S6 cell sorter uses air-cooled and solid state lasers that do not have special power or cooling requirements.

The system also supports up to 9 installed lasers.



Lasers emit intense, coherent electromagnetic radiation that can cause irreparable damage to skin and eyes. To prevent retinal burns and possible blindness, do not remove laser shielding, defeat interlocks, or attempt to service the cytometer in any location where laser warning labels are attached. See the *BD FACSymphony™ S6 cell sorter Safety and Limitations Guide* for the placement of laser warning labels.

Steering optics direct the laser light in a precise and constant manner onto a focusing lens. The lens focuses the laser light onto the sample core stream within the cuvette flow cell. The lasers are positioned on the sample stream for optimal generation of signals. Since the optical pathway and sample core stream are fixed, optimization is constant from day to day.

Collection optics

From the cuvette flow cell, laser light is collected by a fluorescence objective lens that is gel-coupled to the cuvette to transmit the maximum amount of light. The lens collects and focuses fluorescent light emitted at each of the laser focal points onto individual collection fibers. These fibers transfer the emitted light to the collection optics, as shown in the following figure.

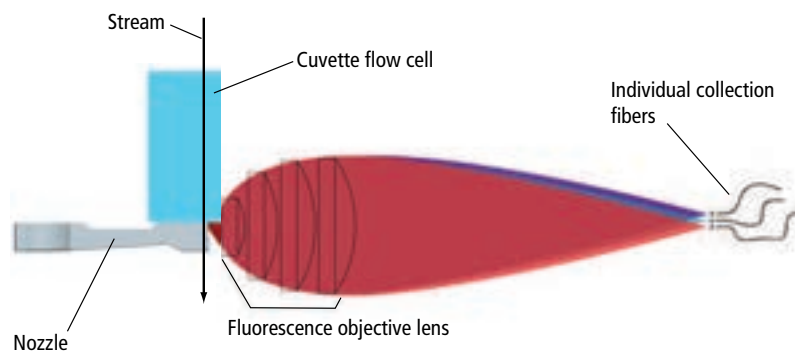

The collection optics are set up in high-parameter cascade (HPC) arrays that are engineered to maximize signal detection from each laser. This is accomplished by transmitting the highest wavelengths to the first photomultiplier tube (PMT), and reflecting lower wavelengths to the next PMT through a series of longpass dichroic mirrors. Bandpass filters in front of each PMT allow fine-tuning of the spectral wavelengths that need to be collected. Since reflection is more efficient than transmission, this design greatly increases the multicolor detection capabilities of the cytometer.



Detectors

The following figure shows the locations of detector arrays in a 5-laser system on the electronics cabinet.





Stream-viewing optics

The BD FACSymphony™ S6 cell sorter is equipped with optical components that are used to view the stream.

- The upper camera generates an image used to monitor drop formation. It is focused on the stream, just below the nozzle, to provide an image of the drop breakoff.
- The lower camera generates an image used for the BD FACS™ Accudrop option. It enhances the ability to

see the side streams and assists in setting an accurate drop-delay value.

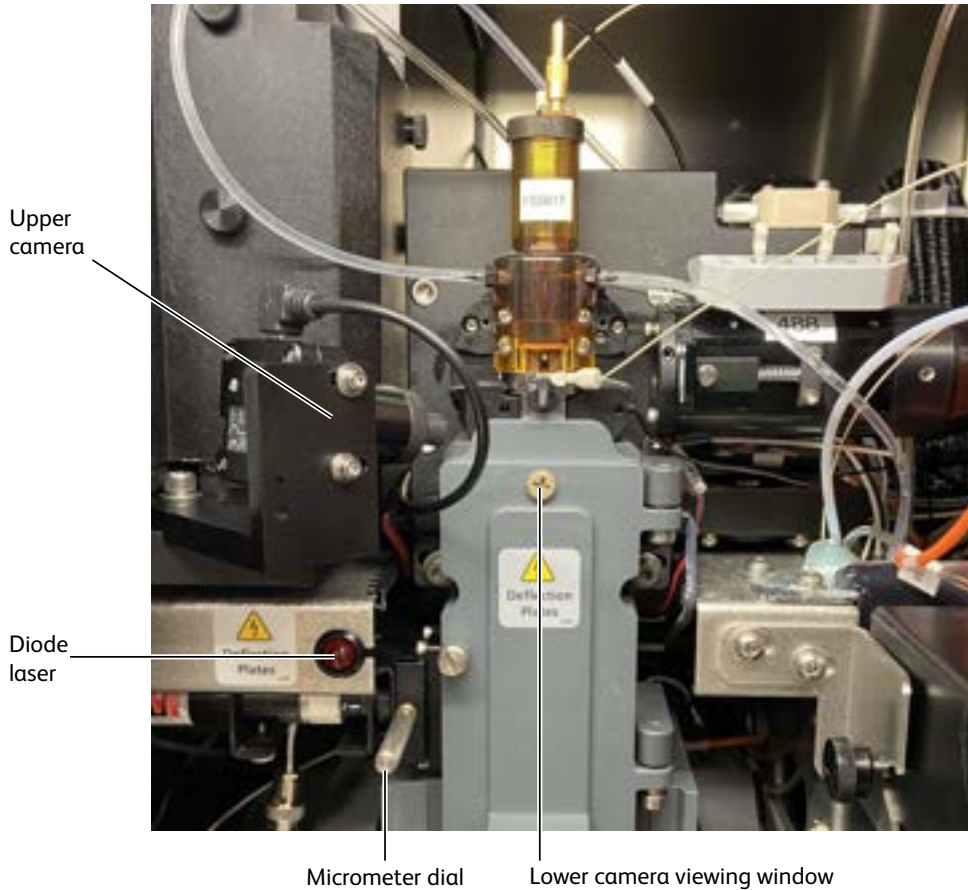

Special image-processing software allows you to view the stream images from each camera within separate windows in BD FACSDiva™ software. See [Sorting \(page 43\)](#) for more information about viewing the streams and to learn how Accudrop components are used to determine the drop delay.

Cytometer electronics

The electronic components consist of the power and air supply panels along with processing boards in the card cage. The power and air supply panels are located on the right side of the cytometer base in the lower left corner. Other electronic components are embedded within the cytometer and do not need adjustment. This section describes only adjustable cytometer electronics. For more information about the electronics, see [Signal detection \(page 37\)](#).

Power and operation

Power to the BD FACSymphony™ S6 cell sorter is supplied by a power cord plugged directly into a standard electrical outlet. The optional BSC is hard-wired to the in-house electrical system.

Power panel

The power panel contains the power button, a USB port for BD service, an ethernet connection, connectors for the stream-viewing cameras, and a serial communications cable.

Power panel for analog cameras:

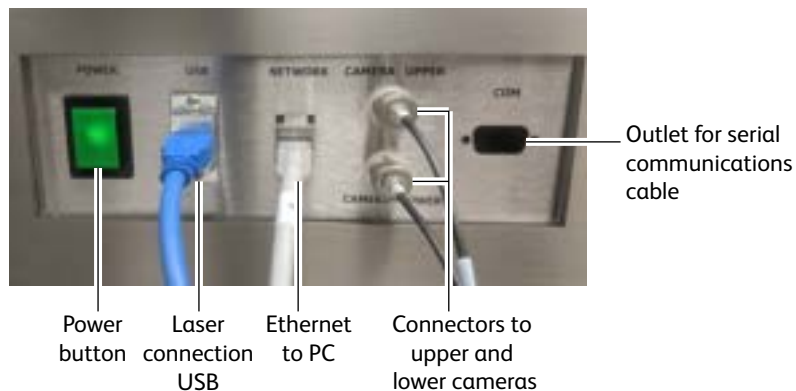

Power panel for digital cameras:

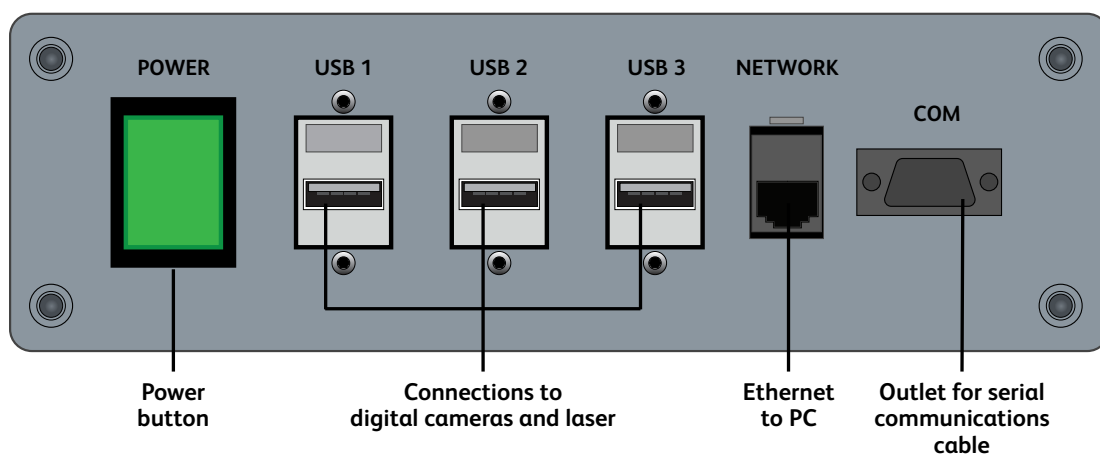

Air supply panel

The air supply panel is located to the right of the power panel. The air supply panel contains the external air regulator, air pressure gauge, power cord, external air input connector, and the cytometer circuit breaker. Air pressure is adjusted using BD FACSDiva™ software.



Connecting to the external air supply

The BD FACSymphony™ S6 cell sorter system requires an external (in-house) air source or optional compressor to operate.

To connect the fluidics to the external air supply, switch on the external air, if necessary. Attach the external air line to the external air input connector. The external air supply must provide 6.6–6.9 Bar (95–100 PSI) regulated. The source of the compressed air must deliver clean (<5 ppm) dry-filtered (oil-free) air at stable pressures.

Emergency stop button

The emergency stop button is a safety feature that can be used to stop the movement of the loading port and ACDU stage. The emergency stop button is located on the front of the optics drawer. The button lights up when a tube is loading to remind you to keep your hands away from the loading port.



The following occur when this button is pushed:

- The software displays the following message:

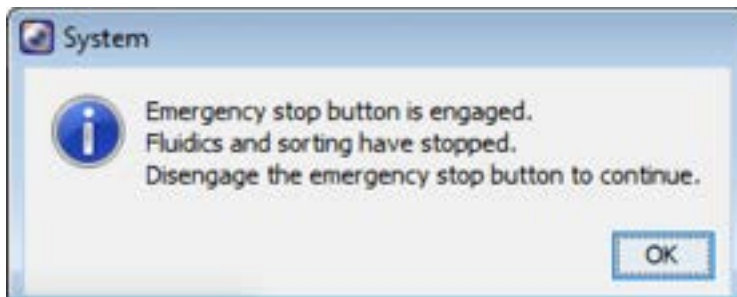

- The tube is unloaded from the sample injection chamber.
- The ACDU stage (if in use) stops moving.
- The stream is turned off.
- The deflection plate voltage is turned off.
- The aspirator drawer (if open) closes to protect the sort collection tubes.

Note: The emergency stop button does not turn off the lasers or shut down the cytometer main power.

To reset the button, slowly turn the button clockwise until the light turns off and the button returns to its original position.

This page intentionally left blank

3

Theory of operation

This chapter describes how the BD FACSymphony™ S6 cell sorter works and how BD FACSDiva™ software controls are used to operate different system components. For a general overview of the software, see [Using BD FACSDiva™ software \(page 55\)](#).

See the following sections for a description of these BD FACSymphony™ S6 cell sorter functions:

- [Fluid movement \(page 34\)](#)
- [Signal generation \(page 36\)](#)
- [Signal detection \(page 37\)](#)
- [Sorting \(page 43\)](#)

Fluid movement

The fluidics system is responsible for moving particles from the sample injection chamber through the cuvette flow cell for interrogation, and then to waste or into a collection device during sorting. The following sections describe the controls used to move fluids through the BD FACSymphony™ S6 cell sorter fluidics system.

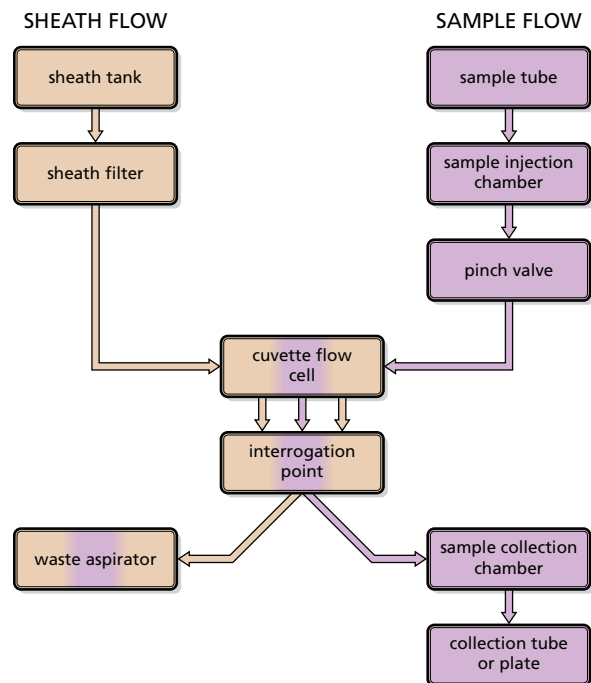

Sheath flow

When you turn on the cytometer, the external air compressor must be turned on or house air must be supplied to the system. The fluidics system is activated when you select the Fluidics Startup command in BD FACSDiva™ software. During fluidics startup, sheath fluid is forced from the pressurized sheath tank through a filter and is delivered to the cuvette flow cell at a constant pressure. You can view the current sheath pressure setting by selecting Cytometer > Sheath Pressure.



After fluidics startup, sheath flow is controlled using the Stream button in the Breakoff window. When clicked, the button changes from a red "X" to a green check mark, and sheath flows through the cuvette flow cell at the rate that is specified in the Sheath Pressure dialog. (See [Drop Formation \(page 43\)](#) for a complete description of the Breakoff window.)



As a general rule, the sheath pressure level is set by selecting a sort setup mode from the Sort menu, rather than by adjusting the sheath pressure control. Each sort setup mode is optimized at a preset sheath pressure. If you change the sheath pressure, a multitude of other values will be affected and need updating, including the drop-drive frequency, drop-delay value, laser delay, area scaling factor, and other values. For more information, see [Sort setup \(page 70\)](#).

Sample flow

Sample is introduced into the cuvette when the Load button is clicked on the Acquisition Dashboard. After Load is clicked, the loading port rises to enclose the tube within the sample injection chamber. The chamber is automatically pressurized and the chamber pressure forces sample through the sample line into the cuvette flow cell. To stop sample flow after a tube is loaded, click the Stop Acquiring button.

The sample flow rate is specified using the Flow Rate field on the Acquisition Dashboard. You can adjust the flow rate from 1–11, which corresponds to approximately 10–80 $\mu\text{L}/\text{minute}$.

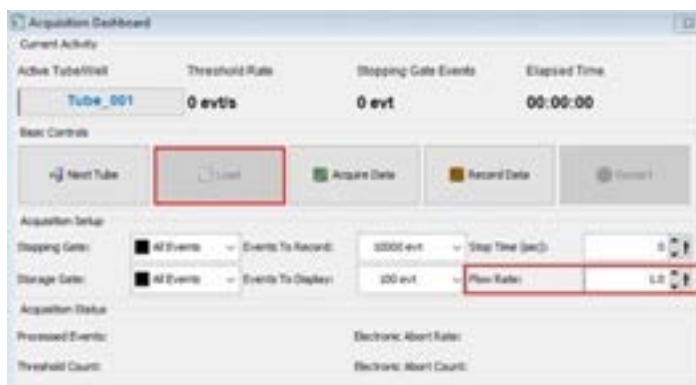

Note: The relatively longer sample tubing on the BD FACSymphony™ S6 cell sorter results in a different flow rate between cells and beads. Thus, absolute counting using BD Trucount™ Beads can yield erroneous results.

Hydrodynamic focusing

In the flow cell, pressurized sheath fluid surrounds the sample fluid to hydrodynamically focus the core stream of suspended cells into the center of the cuvette, where the particles are intercepted by the laser beam.

The difference in pressure between the sheath fluid and the sample fluid can be used to vary the diameter of the sample core. A lower difference results in a relatively narrow core stream, while a higher difference results in a wider sample stream.

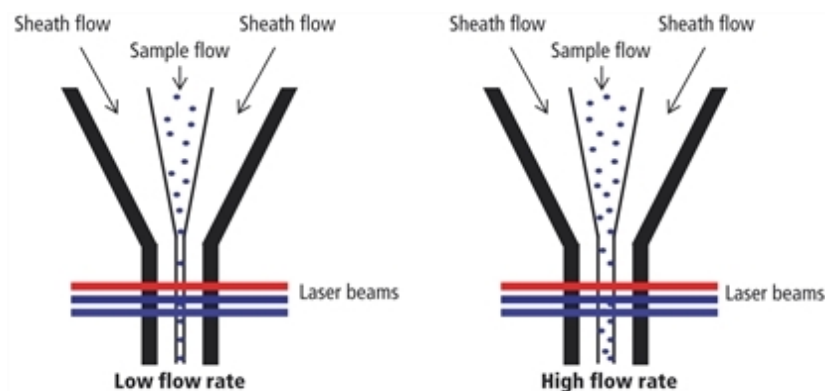

Ideally, you want the core stream at its minimum diameter so that cells pass through the laser beam in a single-file stream. However, depending on your application, a lower resolution might be acceptable in order to acquire the data more quickly. For example, with this three-laser configuration, a higher flow rate is generally used for qualitative measurements such as immunophenotyping—the data is less resolved but is acquired more quickly. A lower flow rate is generally used in applications for which greater resolution is critical.

Signal generation

The following sections describe how signals are generated when cells or particles intercept the laser within the cuvette flow cell.

Light scatter

When a cell or particle passes through a focused laser beam, laser light is scattered in all directions. Light that scatters axial to the laser beam is called forward scatter (FSC). Light that scatters perpendicular to the laser beam is called side scatter (SSC). FSC and SSC are related to certain physical properties of cells:

- FSC indicates relative differences in the size of the cells or particles.
- SSC indicates relative differences in the internal complexity or granularity of the cells or particles.

Fluorescence signals

When cells or particles stained with fluorochrome-conjugated antibodies or other dyes pass through a laser beam, the dyes can absorb photons (energy) and be promoted to an excited electronic state. In returning to their ground state, the dyes release energy, most of which is emitted as light. This light emission is known as fluorescence.

Fluorescence is always a longer wavelength (lower-energy photon) than the excitation wavelength. The difference between the excitation wavelength and the emission wavelength is known as the Stokes shift. Some fluorescent compounds such as PerCP exhibit a large Stokes shift, absorbing blue light (488 nm) and emitting red light (675 nm), while other fluorochromes such as FITC have a smaller Stokes shift, absorbing blue light and emitting green light (530 nm).

The emission spectra for some commonly used fluorochromes are shown in the following figure.

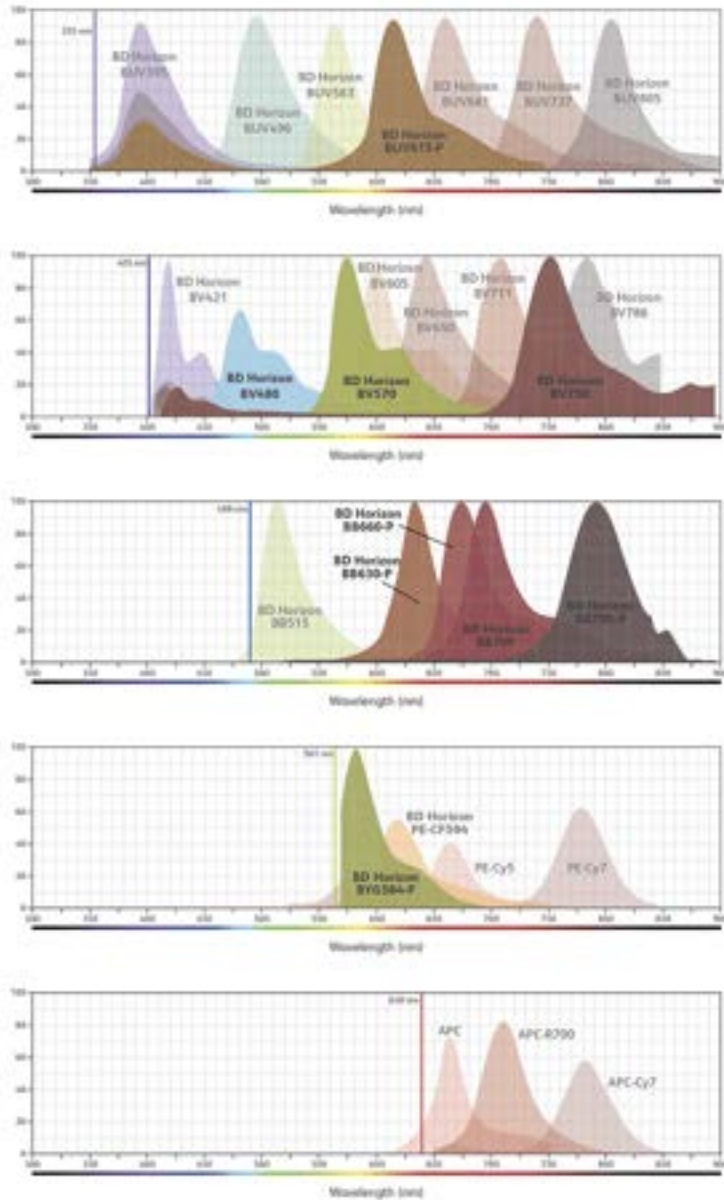

Signal detection

From the cuvette flow cell, scattered and fluorescent light is collected by the fluorescence objective lens. The lens collects and focuses fluorescent light emitted at each of the laser focal points onto individual collection fibers. These fibers transfer the emitted light to the individual detector arrays.

The following sections describe how laser light is detected and translated into signals that can be displayed in a plot.

Detector arrays

The BD FACSymphony™ S6 cell sorter has HPC detector arrays. Each detector array houses dichroic and bandpass filters, which steer and filter the emitted light, and PMTs, which detect light signals.

Filters

Optical filters modify the spectral distribution of light scatter and fluorescence directed to the detectors. Three kinds of filters are used in the detector arrays. Longpass (LP) filters are used to steer light between the detectors within a detector array, while bandpass (BP) and neutral density (ND) filters allow fine-tuning of the spectral wavelengths that need to be collected.

Longpass filters

LP filters pass wavelengths longer than the filter rating and reflect shorter wavelengths. For example, a 500 LP filter permits wavelengths longer than 500 nm to pass through it and reflects wavelengths shorter than 500 nm.

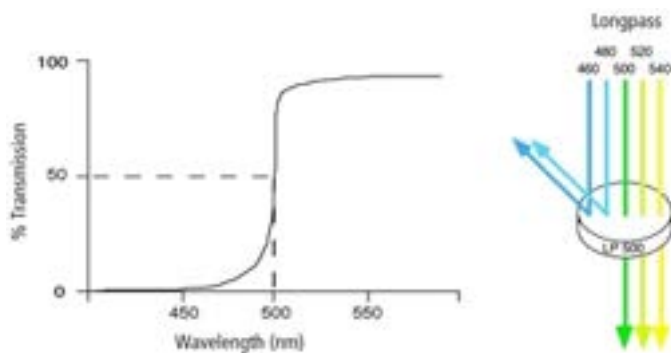

Dichroic filters that are used to direct different color light signals to different detectors are called dichroic mirrors or beam splitters.

Although dichroic mirrors have the properties of LP optical filters, you cannot necessarily use any type of LP filter as a beam splitter. A beam splitter must have a surface coating that reflects certain wavelengths, but many types of LP filters are absorbance filters that do not have any specific reflective characteristics. Also, optical filters and beam splitters are rated at a specific angle of incidence. When used as a beam splitter, they are placed at an angle relative to the light source. Their optical properties are therefore designed for that angle of incidence.

The detector arrays use LP dichroic mirrors to steer progressively shorter wavelengths of light to the next PMT in the array. For example, in the HPC array, light first passes through a 735 LP filter in the A position, followed by a 655 LP filter in the B position. Thus, wavelengths longer than 735 nm are detected at PMT-A. All wavelengths <735 nm are reflected to PMT-B. Wavelengths between 655 nm and 735 nm are detected at PMT-B. All wavelengths <655 nm are reflected to PMT-C, and so on.

Bandpass filters

BP filters transmit a relatively narrow range or band of light. Bandpass filters are typically designated by two numbers. The first number indicates the center wavelength and the second refers to the width of the band of light that is passed. For example, a 500/50 BP filter transmits light that is centered at 500 nm and has a total bandwidth of 50 nm. Therefore, this filter transmits light between 475 and 525 nm.

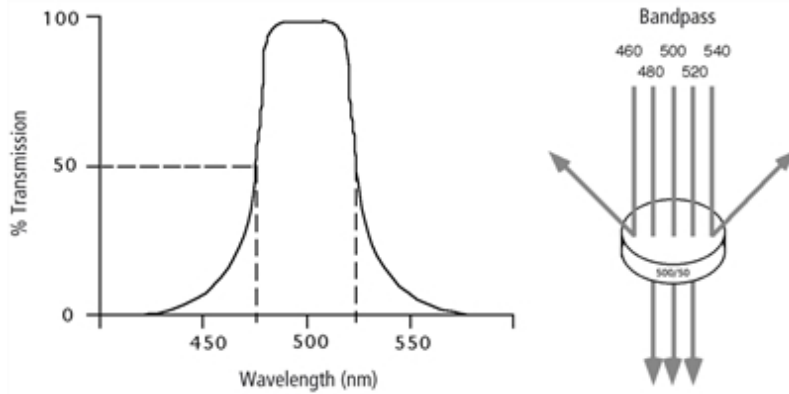

Discriminating (DF) filters have the same general function—they transmit a relatively narrow band of light. The principal difference between BP and DF filters is their construction. DF filters have more cavities or layers of optical coatings, resulting in a steeper transmission curve than the curve for a BP filter. This steep slope means that a DF filter is better at blocking light outside the rated bandwidth of the filter.

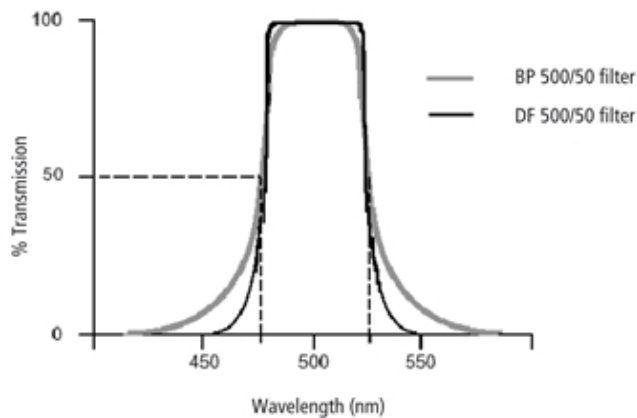

In the detector arrays, DF filters block high-intensity laser light and filter the remaining light to ensure that only the required wavelengths reach their intended detector. For example, in the HPC array, PMT-A has a 780/60 DF filter in front of it, which transmits light of 750–810 nm. Thus, the only wavelengths that will reach the A detector are those between 750 and 810 nm.

For optimal detection of fluorescent light, a bandpass filter must always be installed in front of each detector.

Neutral density filters

ND filters transmit a fixed percentage of light, reducing the transmitted intensity of all wavelengths equally. ND filters are neutral with respect to wavelength.

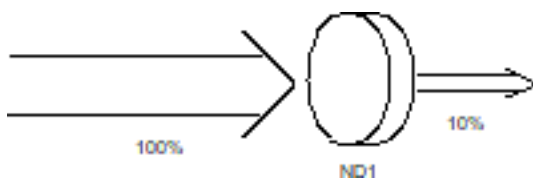

The ND1 filter on the BD FACSymphony™ S6 cell sorter allows approximately 10% of the light to be transmitted. The FSC detector has an ND filter placed in front of the 488/10 BP filter. The percentage of light needed for detection is based on particle size. For applications involving small particles (for example, bacteria or platelets),

you might need to remove the FSC ND filter. For applications involving large particles for which events appear off scale on the FSC axis with a gain of zero, a higher value ND filter is needed to decrease the FSC signal and keep the events on scale.

The system comes with three ND filters: 1.0, 1.5, and 2.0, where the transmission percentage is 10%, 3%, and 1%, respectively. See [Removing or installing the FSC ND filter \(page 168\)](#).

Detectors

Detectors within each detector array convert light signals into electrical signals that can be processed by the electronics system.

There are two types of signal detectors in the BD FACSymphony™ S6 cell sorter flow cytometer: the photodiode and PMTs. The photodiode is less sensitive to light signals than the PMTs, and is used to detect the stronger FSC signal. The photodiode detects FSC light from the blue laser, and is stored outside the detector arrays. PMTs are used to detect the weaker signals generated by SSC and all fluorescence channels.

In BD FACSDiva™ software, the Cytometer Configuration window lets you define which fluorochromes or cell parameters will be measured at each PMT detector. If more than one fluorochrome is measured using the same PMT, you can add additional parameters to your configuration and select the appropriate fluorochrome within your software experiment. See [Cytometer configuration \(page 59\)](#) for more information.

Electronic processing

As cells or other particles pass through the focused laser beams, they scatter the laser light and can emit fluorescence. Because each laser beam is focused on a small spot and particles move rapidly through the flow cell, the scatter or fluorescence emission has a very brief duration—only a few microseconds. The PMTs convert this brief flash of light into an electrical signal called a pulse.

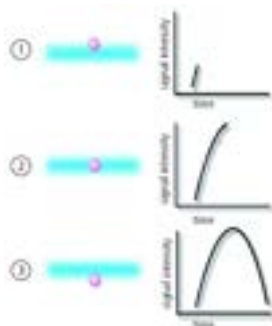

No.	Description
1	A pulse begins when a particle enters the laser beam. At this point, both the beam intensity and signal intensity are low.
2	The pulse reaches a maximum intensity or height when the particle reaches the middle of the beam, where the beam and signal intensity are the brightest. The peak intensity, or height of the pulse, is measured at this point.
3	As the particle leaves the beam, the pulse trails off.

Pulse parameters

A parameter is a pulse property that is generated by a single PMT or photodiode, measuring fluorescent or scattered light. You can measure three characteristics of a pulse: area, height, and width. The pulse height

measures the maximum digitized value for the pulse, the pulse area calculates the sum of all height areas for the pulse, and the pulse width measures the time that the signal is above the threshold.

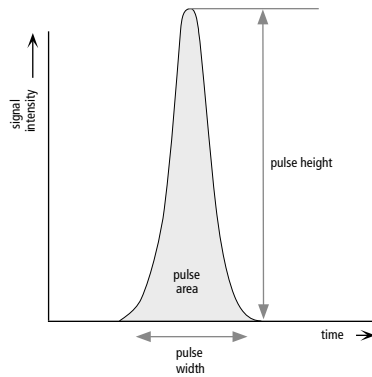

You can select which pulse characteristics you want to measure for each parameter using the Parameters tab. Pulse area (A) is measured by default. The Parameters tab also contains voltage controls that allow you to amplify signals by applying a voltage to PMTs or an electronic gain to the FSC signal. As the voltage is increased, the detector sensitivity increases, resulting in increased signal. As the voltage is decreased, the detector sensitivity decreases, resulting in decreased signal.

Cytometer - FACSAriaII (FACSymphony S6) (R96293700025)

Parameter	Voltage	Log	A	H	W
• PSC	474	<input type="checkbox"/>	<input checked="" type="checkbox"/>	<input checked="" type="checkbox"/>	<input type="checkbox"/>
• SSC	270	<input type="checkbox"/>	<input checked="" type="checkbox"/>	<input checked="" type="checkbox"/>	<input type="checkbox"/>
• 00515	579	<input checked="" type="checkbox"/>	<input checked="" type="checkbox"/>	<input checked="" type="checkbox"/>	<input type="checkbox"/>
• 00555	484	<input checked="" type="checkbox"/>	<input checked="" type="checkbox"/>	<input checked="" type="checkbox"/>	<input type="checkbox"/>
• 00615	532	<input checked="" type="checkbox"/>	<input checked="" type="checkbox"/>	<input checked="" type="checkbox"/>	<input type="checkbox"/>
• 00660	585	<input checked="" type="checkbox"/>	<input checked="" type="checkbox"/>	<input checked="" type="checkbox"/>	<input type="checkbox"/>
• 00700	515	<input checked="" type="checkbox"/>	<input checked="" type="checkbox"/>	<input checked="" type="checkbox"/>	<input type="checkbox"/>
• 00750	583	<input checked="" type="checkbox"/>	<input checked="" type="checkbox"/>	<input checked="" type="checkbox"/>	<input type="checkbox"/>
• 00790	684	<input checked="" type="checkbox"/>	<input checked="" type="checkbox"/>	<input checked="" type="checkbox"/>	<input type="checkbox"/>
• APC	620	<input checked="" type="checkbox"/>	<input checked="" type="checkbox"/>	<input checked="" type="checkbox"/>	<input type="checkbox"/>
• APC-R700	549	<input checked="" type="checkbox"/>	<input checked="" type="checkbox"/>	<input checked="" type="checkbox"/>	<input type="checkbox"/>
• BR750	613	<input checked="" type="checkbox"/>	<input checked="" type="checkbox"/>	<input checked="" type="checkbox"/>	<input type="checkbox"/>
• APC-H7	647	<input checked="" type="checkbox"/>	<input checked="" type="checkbox"/>	<input checked="" type="checkbox"/>	<input type="checkbox"/>
• BR805	733	<input checked="" type="checkbox"/>	<input checked="" type="checkbox"/>	<input checked="" type="checkbox"/>	<input type="checkbox"/>
• BYG504	711	<input checked="" type="checkbox"/>	<input checked="" type="checkbox"/>	<input checked="" type="checkbox"/>	<input type="checkbox"/>
• BYG630	524	<input checked="" type="checkbox"/>	<input checked="" type="checkbox"/>	<input checked="" type="checkbox"/>	<input type="checkbox"/>
• BYG660	564	<input checked="" type="checkbox"/>	<input checked="" type="checkbox"/>	<input checked="" type="checkbox"/>	<input type="checkbox"/>
• BYG720	550	<input checked="" type="checkbox"/>	<input checked="" type="checkbox"/>	<input checked="" type="checkbox"/>	<input type="checkbox"/>
• BYG750	620	<input checked="" type="checkbox"/>	<input checked="" type="checkbox"/>	<input checked="" type="checkbox"/>	<input type="checkbox"/>
• BYG780	717	<input checked="" type="checkbox"/>	<input checked="" type="checkbox"/>	<input checked="" type="checkbox"/>	<input type="checkbox"/>
• BY421	456	<input checked="" type="checkbox"/>	<input checked="" type="checkbox"/>	<input checked="" type="checkbox"/>	<input type="checkbox"/>
• BV510	478	<input checked="" type="checkbox"/>	<input checked="" type="checkbox"/>	<input checked="" type="checkbox"/>	<input type="checkbox"/>
• BV570	456	<input checked="" type="checkbox"/>	<input checked="" type="checkbox"/>	<input checked="" type="checkbox"/>	<input type="checkbox"/>
• BV605	525	<input checked="" type="checkbox"/>	<input checked="" type="checkbox"/>	<input checked="" type="checkbox"/>	<input type="checkbox"/>

Add Delete

Digital data is displayed on an 25-bit linear scale, from 2.6–33,554,432. Select the Log checkbox to convert the display to a log scale. The Experiment Inspector contains an option to display log data on a four- or five-decade scale. (See the BD FACSDiva™ Software Reference Manual for more information.)

Laser delay

Sample interrogation takes place within the cuvette flow cell. Fiber optic cables are used to direct laser light through a series of prisms that focus each laser on the stream at a separate position. This allows optimal detection of fluorescence signals from each laser with minimal cross-contamination from the other beams.

In a three-laser system, the red laser intercepts the stream first, followed by the blue and then the violet laser. Because the laser signals are spatially separated, there is a slight delay between the detection of each laser's signal.

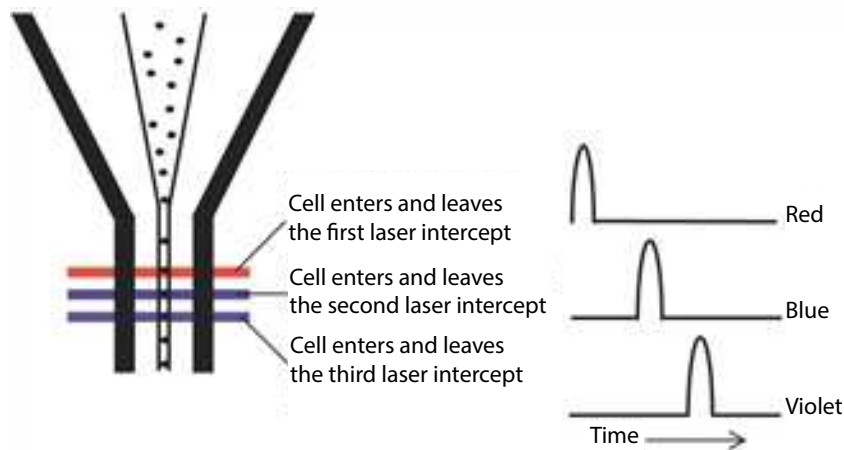

The delay factor in BD FACSDiva™ software is used to realign the signals so they can be measured and displayed on the same time scale. Signals are aligned with respect to the blue laser, so some lasers may have a negative delay value.

Laser delay is set automatically when you use the CS&T module. For information about manually adjusting the laser delay, see [Manual adjustment of laser delay \(page 116\)](#).

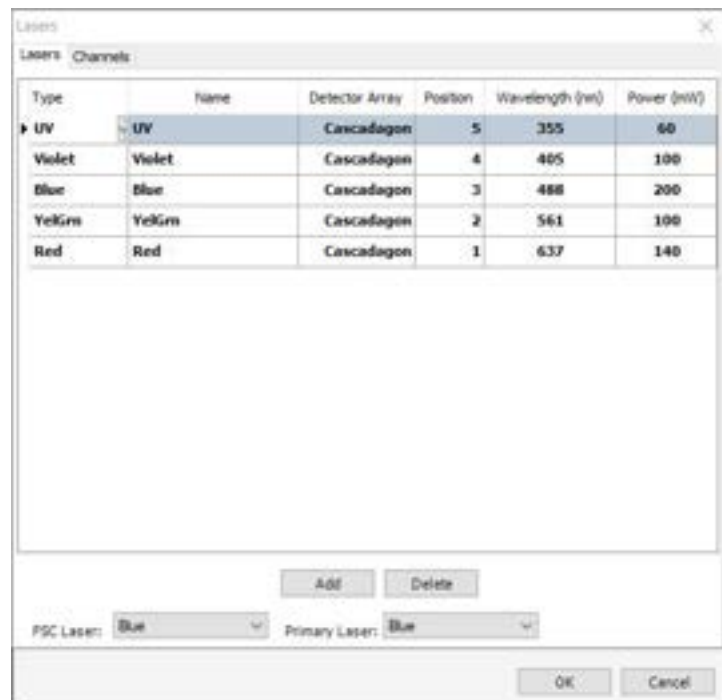

Sorting

While sorting, drop-drive energy is applied to the stream to break it into highly uniform droplets. Droplets detach from the stream a few millimeters downstream from the nozzle. The time between when a particle intercepts the laser and when it reaches the droplet breakoff point is determined using BD FACS™ Accudrop technology (see [Drop-Delay Overview \(page 49\)](#)).

When a particle is detected and meets the predefined sorting criteria, an electrical charge is applied to the stream just as the droplet containing that particle breaks off from the stream. Once broken off from the stream, the droplet—now surrounded by air—still retains its charge. The charged droplet passes by two strongly charged deflection plates. Electrostatic attraction and repulsion cause each charged droplet to be deflected to the left or right, depending on the droplet's charge polarity. Uncharged droplets are not affected by the electric field and pass down the center to the waste aspirator.

The following sections describe how the BD FACSymphony™ S6 cell sorter creates and charges drops, how the drops are deflected, and how sorting populations are identified.

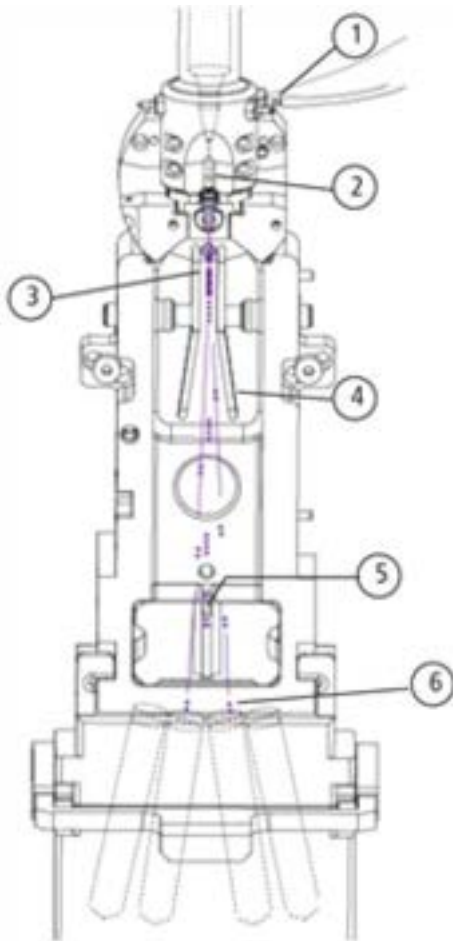

No.	Description
1	Charge is applied via the stream-charging wire in the barb.
2	The sample generates light scatter and fluorescence signal. The signal is analyzed.
3	The charged droplet breaks off.
4	Deflection plates attract or repel the charged droplet.
5	Uncharged droplets pass to waste.
6	Charged drops containing particles of interest are collected.

Drop Formation



The BD FACSymphony™ S6 cell sorter constantly applies drop-drive energy to the stream. Droplets form as soon as you turn on the stream. Sample interrogation takes place upstream of the stream vibration so that analysis

is not affected by the drop drive.

A drop breakoff image is created using an LED strobe and a video camera. The image is displayed in the Breakoff window (see [Breakoff Window \(page 45\)](#)). Patented Sweet Spot technology analyzes the drop breakoff image and provides feedback to the appropriate controls.

Breakoff Window

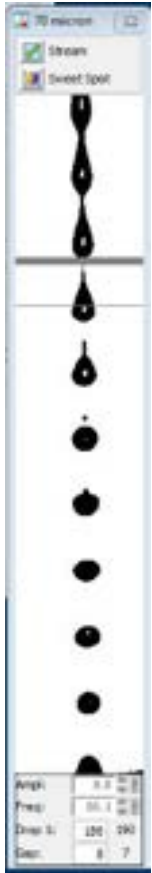
Use the Breakoff window to control a number of aspects related to drop formation.

Control	Description	
Stream button 	Turns the stream on and off.	
Sweet Spot button 	Enables automatic adjustment of the drop-drive amplitude to maintain the stability of the breakoff point. When the Sweet Spot is on, the Amplitude and Frequency fields are disabled. The amplitude is automatically adjusted by the software. To enable the fields, turn off the Sweet Spot.	
Amplitude field	Adjusts the amplitude or intensity of the drop drive, from 1.0–80.0 volts. The drop-drive amplitude determines the breakoff point. A higher amplitude value results in a shorter stream breakoff. A lower amplitude results in a longer stream breakoff. Typically, the amplitude is set once, at the beginning of a sorting experiment, and then maintained using the Sweet Spot.	
Frequency field	Determines the number of drops formed per second and the size of the drops. (Drop size is also influenced by the nozzle size.) The drop-drive frequency can be adjusted from 1.0–102.0 kHz. The higher the frequency, the more drops are generated per second and the smaller the drops. The lower the frequency, the fewer drops generated per second and the larger the drops.	
Frequency field (continued)	In general, the drop-drive frequency should not need adjustment. We recommend using the default values that are entered with each Sort Setup mode.	
Drop 1 field	The distance between the top of the image and the center of the first broken-off drop, from 100–600 pixels. When you enter a value and turn on the Sweet Spot, the cytometer automatically adjusts the amplitude to attain your target value. NOTE Not all Drop 1 targets are attainable. The Drop 1 value jumps in whole increments of approximately 57 pixels according to your drop spacing. The same Drop 1 setting can be used from day to day. A difference of up to 10 pixels between the target value and the actual value is acceptable.	
Gap field	This represents the gap between the stream breakoff and the top of the first drop. The default Gap setting for a 70-micron nozzle is 6 pixels.	

Breakoff Functionality

The upper camera transmits an image of the drop breakoff to the Breakoff window, where video image processing software converts the visual characteristics of the image into numerical properties. The drop breakoff is analyzed for two key features: Drop 1 and Gap.

Drop 1 is defined as the number of pixels from the top of the image to the center of gravity of the first broken-off drop. A thin gray line on the image is used to identify this drop. The number shown to the right of the Drop 1 field at the bottom of the window is the actual pixel location of the gray line. The number entered into the Drop 1 field is the user-defined Drop 1 target.

The Gap is defined as the number of pixels from the first discontinuity in the stream to the next stream object, generally the first broken-off drop. A gray line of varying thickness represents the Gap. The number shown to the right of the Gap field is the pixel width of the gray line. The number entered into the Gap field is a user-defined target.

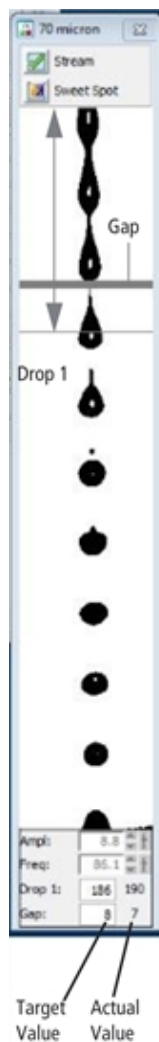

When the Sweet Spot is turned on, the drop-drive amplitude (Ampl) is automatically adjusted to approximately match the target Drop 1 and Gap values. The amplitude is initially adjusted in larger increments until Drop 1 is achieved. The amplitude is then adjusted in smaller increments until the cytometer attains the target Gap. The Sweet Spot function will make adjustments as necessary to maintain the required breakoff conditions throughout the day.

The Sweet Spot performs two other functions during sorting. When sorting, if the Drop 1 or Gap is out of range, sorting is paused until the values are back within range. This ensures that sorting occurs only under the proper breakoff conditions. If a more severe problem such as a clog is detected by the Sweet Spot, the stream is shut off and sorting is stopped, the deflection plates shut off, the aspirator drawer closes, and the sample tube is unloaded.

Pre-programmed values can be downloaded to the Breakoff window by selecting one of the nozzle sizes (70, 85, 100, or 130 micron) from the Sort > Sort Setup menu.

Changes to values in the Sort Setup windows (Breakoff and Side Stream) are automatically saved. At startup, the last settings used on the cytometer are restored, except the Stream and Sweet Spot controls, which always default to off. For more information, see [Sort setup \(page 70\)](#).

Typically, when setting up for sorting, use the Amplitude to set the required drop breakoff, and copy the generated Drop 1 value to the target field. Then, turn on the Sweet Spot to maintain the drop breakoff. When the Sweet Spot detects a >1-pixel difference between the target Gap setting and the actual Gap, it adjusts the amplitude to reduce the Gap. When a >2-pixel difference is detected, the Sweet Spot stops sorting temporarily (stops charging the stream) until the Gap is restored. Note that when the sort is paused, the sample continues to flow. Once the Gap is back within range, sorting automatically resumes.

For information on setting the breakoff, see [Setting up the breakoff \(page 92\)](#).

Side Stream Formation



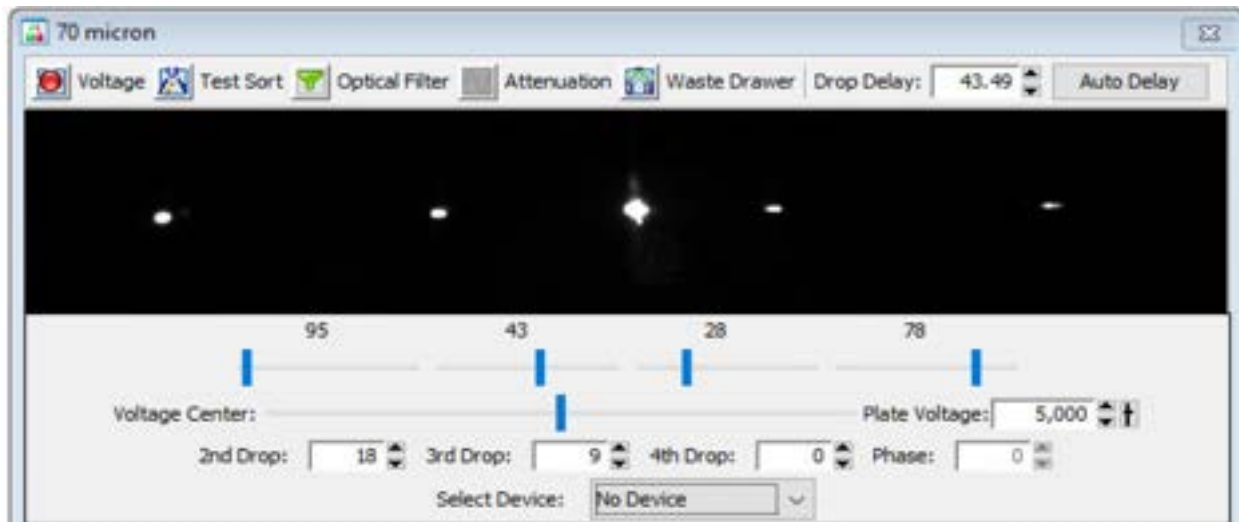

Side streams are formed when the voltage is on and a sort is in progress, or when you click Voltage, then Test Sort in the Side Stream window.

The Side Stream window displays an image of the side streams as transmitted by the lower camera. In addition to the stream image, the Side Stream window contains the controls used to adjust electrical charges and to determine the drop delay using Accudrop, as described in [Drop-Delay Overview \(page 49\)](#).



Controls in the Side Stream window are described in the following table. You can send different values to the Side Stream window by selecting a nozzle size from the Sort > Sort Setup menu.

Note: Changes to values in the Sort Setup windows (Side Stream and Breakoff) are linked to the sort setup and are automatically saved. At startup, the last settings used on the cytometer are restored, except the states of the Voltage, Test Sort, and Optical Filter buttons, which always default to off. For more information, see [Sort setup \(page 70\)](#).

Control	Description
Voltage button 	Turns the plate voltage on and off.
Test Sort button 	Generates test side streams based on test sort pulses.
Optical Filter button 	Controls the position of the optical filter in front of the lower (Accudrop) camera.
Attenuation button 	Decreases the amplitude of the drop drive. At lower pressures, you may need to turn on attenuation to dampen the amplitude.
Waste Drawer button 	Opens or closes the aspirator drawer depending on its current state. The default state is closed. For more information, see Aspirator drawer (page 21) .
Drop Delay field	Sets the amount of time between when an event is measured and the breakoff point, from 10–140 drops. The drop-delay value determines which drop will be deflected. The drop-delay value is set in an experiment using BD FACS Accudrop technology.
Auto Delay	Opens the Auto Drop Delay dialog.
Voltage sliders (far left, left, right, far right)	Set the percentage of charge to be applied to the corresponding stream (as a percentage of maximum).
Voltage Center slider	Adjusts the relative voltage between the left and right plates which moves the streams slightly to the left or right as a whole. In general, this slider rarely needs adjusting.
Plate Voltage field	Adjusts the total voltage difference between the plates, which determines the angle of stream deflection. The voltage values change with different nozzle sizes.
2nd, 3rd, 4th Drop fields	Apply a correction factor for the drop charge as a percentage of the previous drop, from –100% to 100%.
Phase field	Adjusts the phase between drop generation and charging of the droplets from 0–360°. The selected value is sent to both the drop-charging electrode and the drop strobe. In general, the Phase does not need adjusting. You can keep the default value of zero.
Select Device	Collection device menu for setup of aspirator digital reference lines linked to a specific collection device.

Drop-Delay Overview

The BD FACSymphony™ S6 cell sorter includes integrated Accudrop technology to assist in setting an accurate drop delay value. Accudrop components consist of the following:

- A diode laser, mounted to the left of the sort block
- A camera that provides an image of the side streams
- An emission filter for viewing the fluorescence from BD FACST™ Accudrop Beads

The emission filter is installed in front of the lower camera and can be moved in and out by clicking the Optical Filter control. When the button is green (), the filter is out. This position is used to view the center and side streams.

Click the button to move the filter in front of the camera when you are determining the drop delay. The button changes to red (). To determine the drop delay, the streams are illuminated by the diode laser just below the point of deflection. Specialized fluorescent particles (Accudrop Beads) can be viewed in the center and left side streams as the delay is adjusted. The best delay yields the most particles in the left stream and the fewest in the center stream.

See [Determining the drop delay – manual method \(page 123\)](#) for more information.

Auto Drop Delay

The Auto Drop Delay feature enables the system to optimize the drop delay automatically. See [Determining the drop delay – automatic method \(page 126\)](#).

Drop Charging

Drops are charged when an event is detected and meets the defined sorting criteria, as specified in the Sort Layout window.

The Sort Layout window contains all sorting instructions and controls. The sort layout designates which device will be used to collect sorted particles and which particles will be sorted into each sort location. Up to six sort counters can be displayed in the window to give ongoing status during a sort. Depending on your system's configuration, your setup values may vary.

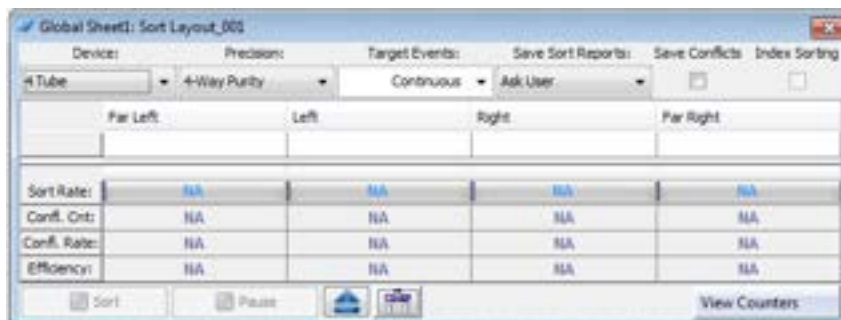

Target events are identified by drawing gates around populations of interest in plots. The Sort Layout window specifies which gated population should be sorted into each sort collection tube or spot in a plate or on a slide. During sorting, when an event is identified within one of the sort gates, the drop containing the particle of interest is charged by the stream-charging wire attached to the flow cell.

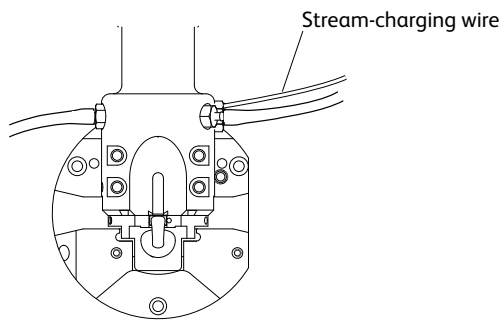

The amount and type of charge determine where the drop will be sorted. For example, in a four-way sort, drops with the most charge will be deflected into the outer streams, while drops with less charge will be deflected into the inner streams.

Conflict Resolution During Sorting

During sorting, the cytometer deflects drops based on the characteristics of the particles in each drop and where the user wants to deflect them. Conflicts can occur depending on the type of target particle, where the particle is located within a drop, or whether the drop is free of contaminating particles. BD FACSDiva™ software accurately measures particle position to within 1/32 of a drop.

Mask settings determine how drops are deflected when sorting conflicts occur. There are three mask settings, each of which addresses a different type of conflict. These settings are combined to define sort precision modes. Each mode is made up of a set of masks. Precision modes are defined in the Sort Precision dialog, accessed from the Sort menu.



Yield Mask

The yield mask setting defines how close to the edge of the drop, in 1/32-drop increments, a particle of interest can be located before sorting an additional drop. Half of each yield mask setting defines an equal area at each end of the drop.

For example, when the yield mask is set to 16 and an event is within 8/32 from the beginning of a drop, the previous (leading) drop will be sorted. If an event is within 8/32 from the end of a drop, the following (trailing) drop will be sorted.

Trailing drop: not sorted Drop being interrogated Leading drop: not sorted

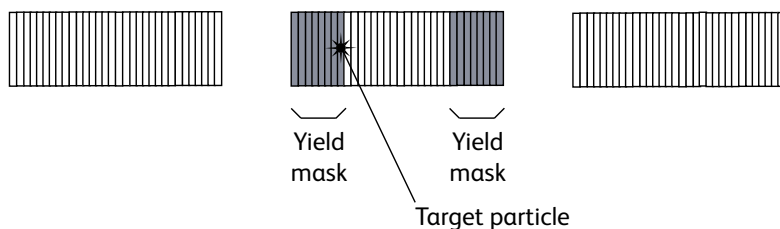

If the yield mask were set to 8 for the same target particle, the target particle would fall outside the yield mask. Therefore, no additional drops would be sorted.

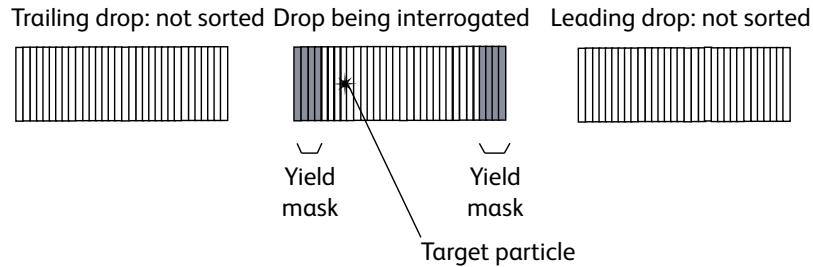

When the yield mask is set to zero, only one drop (the drop containing the target particle) will be deflected. When the mask is set to 32, two drops will always be deflected. Yield masks between 0 and 32 will sort either one or two drops.

Yield masks cannot be used in conjunction with phase masks. Therefore, when the yield mask is greater than zero, the phase mask automatically reverts to zero.

Purity Mask

The purity mask setting defines how close, in 1/32-drop increments, a contaminating drop can be located before ignoring the drop being interrogated.

For example, when the purity mask is set to 16, the drop being interrogated will not be sorted if a non-target particle falls within the first or last 8/32 of the leading or trailing drop. In the following example, a non-target particle falls within the first 8/32, so the interrogated drop will not be sorted.

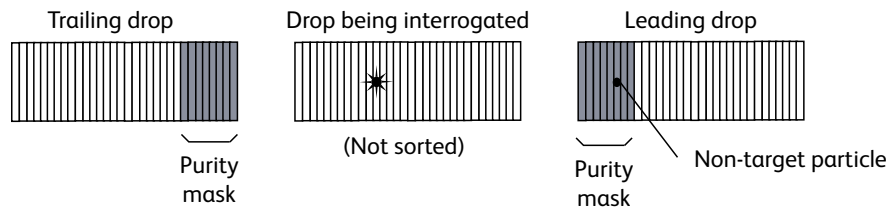

If the purity mask were set to 8 for the same target particle, the non-target particle would fall outside the purity mask, so the interrogated drop would be sorted.

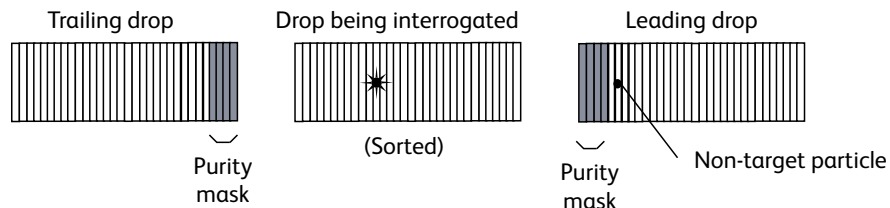

With any purity mask greater than zero, the drop being interrogated must be free of contaminating particles or the drop will not be sorted. If the purity mask is set to zero, a droplet containing the event of interest will be sorted regardless of contaminating particles.

Phase Mask

Particles near the drop edge can affect the breakoff and alter the trajectory of the deflected drop. The phase mask restricts drop deflection when an event is too close to the edge of a drop or when there are events close to

the edge of adjacent drops. A phase mask is used to improve counting accuracy and side-stream quality at the expense of yield.

For example, when the phase mask is set to 16, the drop being interrogated will be sorted only if the target particle falls outside the phase mask.

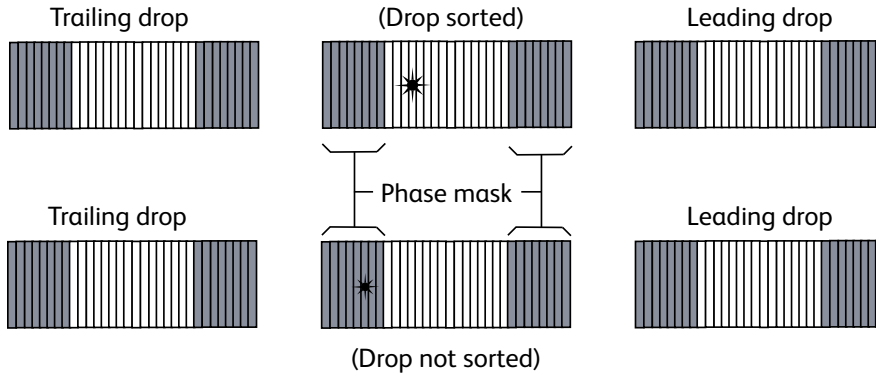

Decreasing the phase mask to 8 allows more drops to be sorted. However, because the target particle is closer to the edge of the drop, there is more variability in drop trajectory.

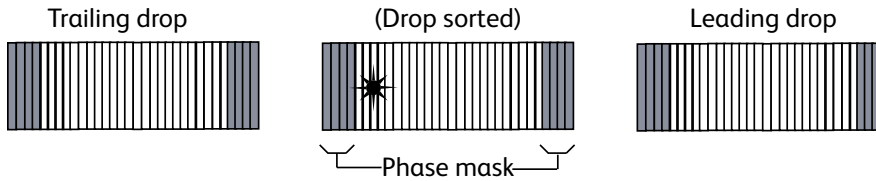

Note: We recommend using a phase mask of at least 8 when sorting single cells.

Phase masks cannot be used in conjunction with yield masks. Therefore, when the phase mask is greater than zero, the yield mask automatically reverts to zero.

Sort Precision Modes

Mask values can be combined in many different ways. By default, six sort precision modes are already defined: Purity, 4-Way Purity, Yield, Single Cell, Initial, and Fine Tune.



	Precision Mode					
	Purity	4-Way Purity	Yield	Single Cell	Initial	Fine Tune
Yield Mask	32	0	32	0	32	0
Purity Mask	32	32	0	32	0	0
Phase Mask	0	0	0	16	0	0
Single Cell	–	–	–	X		–

- **Purity mode.** The yield mask is set to the maximum to obtain the greatest number of particles. Because the purity mask is also set to the maximum, only drops free of contaminating particles will be sorted. Sorting in Purity mode results in a sorted sample that is highly pure, at the expense of recovery and yield.
- **4-Way Purity mode.** The purity mask is set to the maximum, so only drops free of contaminating particles will be sorted. The yield mask is set to zero to ensure that residual charges from adjoining drops do not degrade the quality of side streams. The 4-Way Purity mode is recommended for 4-way sorting and 6-way sorting, when precise deflection is required.
- **Yield mode.** Only the yield mask is used at its maximum value. Recovery and yield are optimized at the expense of purity. The yield mode could be used as a first round sort for enrichment of target particles, followed by a sort for purity.
- **Single Cell mode.** The purity mask is set to the maximum, so only drops free of contaminating particles will be sorted. The phase mask is set to half the maximum, so only particles centered within the sorted drop are deflected. Drop trajectory and count accuracy are optimized at the expense of yield. This mode is recommended for plate sorting or situations when precise counting is required.

The remaining modes are used mainly during drop-delay determination. Initial mode is equivalent to Yield mode, but it is named differently as a reminder to use this as the initial mode when using Accudrop to set the drop delay.

- **Initial mode.** Only the yield mask is used at its maximum value. Recovery and yield are optimized at the expense of purity.
- **Fine Tune mode.** All masks are set to zero to deflect the maximum number of drops. This mode is used to fine-tune the drop-delay value. See [Determining the drop delay – manual method \(page 123\)](#) for more information.

Defining New Precision Modes

Default precision modes cannot be edited or deleted. However, you can create new modes and then select them from the Precision Mode menu.

1. Select **Sort > Sort Precision**.



2. Click **Add**.
The current sort mode is duplicated and the Mask fields are enabled.
3. (Optional) Change the name of the mode in the Precision Mode field.

4. Enter values for Yield Mask, Purity Mask, and Phase Mask.
5. Select the **Single Cell** checkbox, if needed.
6. Click **Close**.

The new mode is added to the Precision Mode menu.

To delete a mode, select it from the **Precision Mode** menu and click **Delete**.

4

Using BD FACSDiva™ software

Many BD FACSymphony™ S6 cell sorter functions are controlled using BD FACSDiva™ software. This chapter provides a general overview of the workspace components and describes software controls that are unique to the BD FACSymphony™ S6 cell sorter cytometer. For an in-depth description of software components not described in this chapter, see the *BD FACSDiva™ Software Reference Manual*.

The following topics are covered in this chapter:

- [Workspace components \(page 56\)](#)
- [Cytometer controls \(page 56\)](#)
- [Sorting controls \(page 69\)](#)
- [Reference line setup for digital cameras \(page 77\)](#)
- [Sort alignment software for analog cameras \(page 80\)](#)
- [Templates \(page 85\)](#)

Workspace components

When you start BD FACSDiva™ software, the workspace opens. For a general overview of the workspace and to get started using the software, see the tutorials and quick reference guides located in the Resource Library on the BD Biosciences website (bdbiosciences.com). When running BD FACSDiva™ software with the BD FACSymphony™ S6 cell sorter, two additional windows can be displayed by clicking the Sorting button on the Workspace toolbar. See [Sorting controls \(page 69\)](#) for a description.

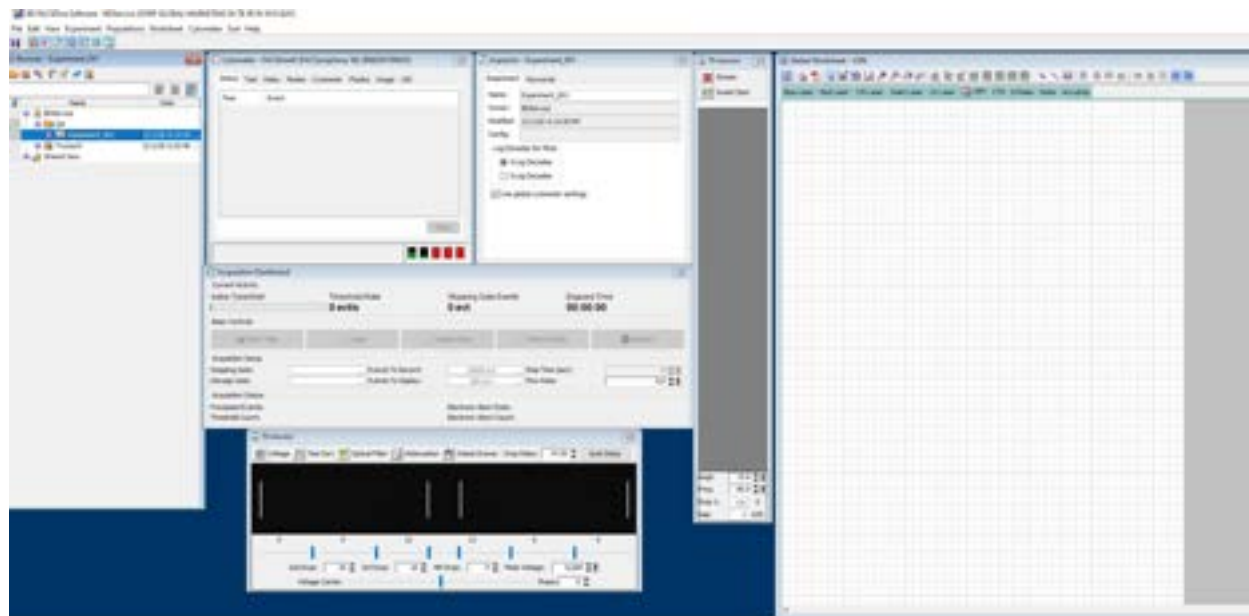

Cytometer controls

Most BD FACSymphony™ S6 cell sorter–specific cytometer controls are accessed through the Cytometer menu. Controls on the Cytometer menu are described in the following sections:

- [Fluidics controls \(page 56\)](#)
- [Cytometer configuration \(page 59\)](#)
- [Cytometer status report \(page 60\)](#)

The Cytometer Details and the Catalogs menu commands are described in the *BD FACSDiva™ Software Reference Manual*. Additional cytometer controls are located on the Acquisition Dashboard. See [Acquisition controls \(page 68\)](#).

Fluidics controls

Fluidics control of the BD FACSymphony™ S6 cell sorter is partially automated by BD FACSDiva™ software. The software contains pre-programmed fluidics protocols that are activated by selecting the corresponding menu command from the Cytometer menu. In addition, fluidics level indicators are available in the Cytometer window. See [Fluidics level indicators \(page 58\)](#).

Fluidics Startup

During fluidics startup, waste and sheath levels are verified and the fluidics system is primed with sheath solution. The fluidics status is displayed at the bottom of the main window.



See [Cytometer startup \(page 88\)](#) for more information.

Fluidics shutdown

Fluidics shutdown removes sheath fluid from the lines, replaces it with ethanol, and cleans the cuvette with a cleaning solution. See [Fluidics Shutdown \(Weekly or As Needed\) \(page 142\)](#) for more details.

Change sample filter

Sample line filters can be installed to filter a sample before sorting. This selection opens the Sample Filter Change wizard, which guides you through the process. See [Installing or removing a sample line filter \(page 159\)](#) for the instructions.

Cleaning modes

BD FACSDiva™ software contains pre-programmed cleaning modes that are activated by selecting the corresponding menu command from the Cytometer > Cleaning Modes menu. See [Internal cleaning \(page 144\)](#) for more information.

Sheath pressure

The sheath pressure determines how quickly particles pass through the laser beam. Select Cytometer > Sheath Pressure to view the current sheath pressure and change the pressure for custom sort setups.



Each sort setup option is optimized at a preset sheath pressure. If you change the sheath pressure, many other values will be affected and need updating, including the drop-drive frequency, drop-delay value, laser delay, and area scaling factor. For proper cytometer operation, change the sheath pressure by selecting an option from the Sort > Sort Setup menu. Do not adjust the pressure using controls in the Sheath Pressure dialog.

Note: The Sheath Pressure command is disabled when the Sweet Spot is on.

Sample agitation

Select Cytometer > Sample Agitation to specify the speed at which samples are agitated. You can select from one of the specified values, or select Off to turn off agitation.

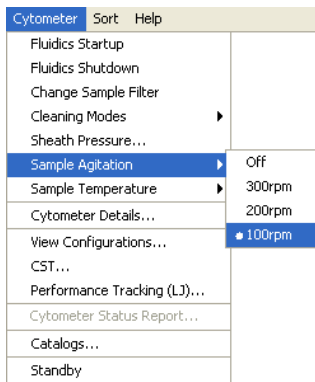

Sample temperature

Use the Sample Temperature command to set the temperature inside the sample injection chamber. You can select from one of the specified values, or select Off to turn off temperature control.

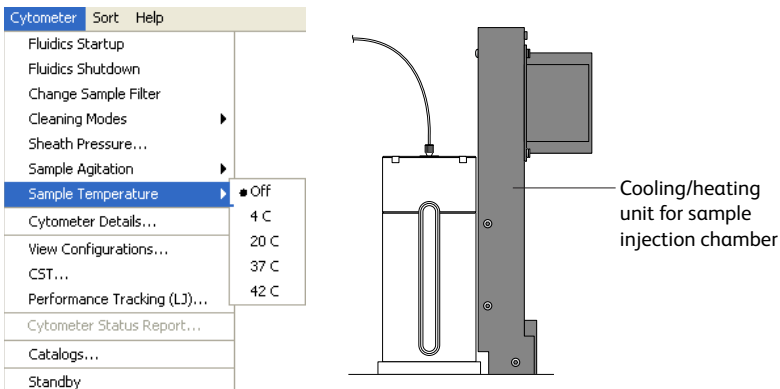

The cooling/heating unit is designed to maintain the temperature of a sample tube. It is not designed to cool or heat the sample. It takes approximately 45 minutes to reach the required temperature inside the chamber, during which time the chamber must be kept closed.

To cool or heat the chamber, install a sample tube and click Load. Click Stop Acquiring to keep the chamber closed and stop running the sample. To maintain the temperature, do not leave the chamber open for extended periods while changing sample tubes.

The sample temperature retains the last setting after startup. For example, if it was set to 20 °C the last time the system was used, then it will return to that setting the next time the system is started up.

Fluidics level indicators

BD FACSDiva™ software provides fluidics level indicators in the Cytometer window. The sheath and waste indicators provide an approximate indication of the fluid levels in each tank. The DI, bleach, and ethanol tank indicators appear full until the fluid level is below 20% of the tank capacity. When this occurs, the corresponding level indicator changes to black.

Note: The stainless steel ethanol shutdown tank does not have a level sensor. It must be checked manually.

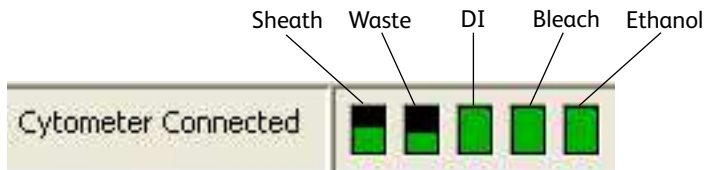

When the sheath is low or the waste is full while the stream is running, the corresponding indicator turns red and the following warning message is displayed every 5 minutes until the stream is turned off. If the warning message is not closed, the system automatically turns off the stream after 15 minutes.



Do not close the warning message without refilling the sheath or emptying the waste. If you continue to run the cytometer after closing the message, the system could shut down.

Cytometer configuration

The menu selections shown in the following figure open the CS&T module in a separate window. The CS&T module enables you to perform multiple functions related to cytometer configuration.

Note: When the CS&T module is open, BD FACSDiva™ software goes into a holding mode and does not accept any user input. When CS&T is closed, BD FACSDiva™ software becomes active again.



- **View Configurations.** Opens the Cytometer Configuration window within the main CS&T window. See the following section for an overview of this function.
- **CST.** Opens the CS&T module. See the *BD® Cytometer Setup and Tracking Application Guide* for complete information on using BD® CS&T Research Beads.
- **Performance Tracking (LJ).** Opens the performance tracking feature within the main CS&T window. See the *BD® Cytometer Setup and Tracking Application Guide* for complete information on using this feature.

Cytometer configuration window

The BD FACSymphony™ S6 cell sorter cytometer is equipped with a specific set of lasers, filters, and dichroic mirrors. The Cytometer Configuration window lets you define which fluorochromes or cell parameters will be measured at each PMT detector. Within this window, you can define the filters and assign the fluorochromes to the detectors.

Select **Cytometer > View Configurations** to open the window. Click the **Parameter** tabs for a list of parameters. Click the **Filters and Mirrors** tab for the list of optics.

The Cytometer Configuration window also displays the following settings:

- Sheath pressure
- Nozzle size
- Window extension

See [Custom configurations \(page 61\)](#) for more information on editing configurations, including adding parameters, mirrors, and filters.

Before you start any experiment, verify that the cytometer configuration contains the appropriate parameters for the samples you are running and that the cytometer optics match the current configuration. You cannot modify an existing configuration once it has been baselined. However, you can copy, paste, or modify a configuration as described in [Custom configurations \(page 61\)](#).



For accurate data results, the cytometer optics must match the current cytometer configuration.

Selections in the Cytometer Configuration window determine which parameters are available for your experiment.



Cytometer status report

The Cytometer Status Report provides a list of all cytometer settings at the time the report was created. The cytometer must be connected to create the report. In an open experiment, click to set the current tube pointer and select **Cytometer > Cytometer Status Report**. The report is displayed in a separate window with a menu bar above the report header. The header lists the cytometer name, type, serial number, and the date and time the report was generated.

For a full description of the Cytometer Status Report, see the *BD FACSDiva™ Software Reference Manual*. A BD FACSymphony™ S6 cell sorter cytometer report includes the following additional information: user access privileges, cytometer information, cytometer settings, and sorting settings. The report can be printed or exported.

- The User Access Privileges section lists access settings for the current user.
- The Cytometer Info section lists values for laser delay, area scaling, window extension, FSC area scaling, sheath pressure, and sample flow rate.
- The Parameters section displays settings for the current acquisition tube.

- The Sort Settings section lists all sort setup values, along with the Plate Voltage and Voltage Center values. If the Sweet Spot is off, Breakoff and Gap values are shown. If the Sweet Spot is on, Drop 1 and target Gap values are shown.

Plate Voltage		Voltage Center	
APC	4.0	4.0	4.0
APC-2	24.0	24.0	24.0
APC-3	8.0	8.0	8.0
APC-4	8.0	8.0	8.0
APC-5	8.0	8.0	8.0
APC-6	8.0	8.0	8.0
APC-7	8.0	8.0	8.0
APC-8	8.0	8.0	8.0
APC-9	8.0	8.0	8.0
APC-10	8.0	8.0	8.0
APC-11	8.0	8.0	8.0
APC-12	8.0	8.0	8.0
APC-13	8.0	8.0	8.0
APC-14	8.0	8.0	8.0
APC-15	8.0	8.0	8.0
APC-16	8.0	8.0	8.0
APC-17	8.0	8.0	8.0
APC-18	8.0	8.0	8.0
APC-19	8.0	8.0	8.0
APC-20	8.0	8.0	8.0
APC-21	8.0	8.0	8.0
APC-22	8.0	8.0	8.0
APC-23	8.0	8.0	8.0
APC-24	8.0	8.0	8.0
APC-25	8.0	8.0	8.0
APC-26	8.0	8.0	8.0
APC-27	8.0	8.0	8.0
APC-28	8.0	8.0	8.0
APC-29	8.0	8.0	8.0
APC-30	8.0	8.0	8.0
APC-31	8.0	8.0	8.0
APC-32	8.0	8.0	8.0
APC-33	8.0	8.0	8.0
APC-34	8.0	8.0	8.0
APC-35	8.0	8.0	8.0
APC-36	8.0	8.0	8.0
APC-37	8.0	8.0	8.0
APC-38	8.0	8.0	8.0
APC-39	8.0	8.0	8.0
APC-40	8.0	8.0	8.0
APC-41	8.0	8.0	8.0
APC-42	8.0	8.0	8.0
APC-43	8.0	8.0	8.0
APC-44	8.0	8.0	8.0
APC-45	8.0	8.0	8.0
APC-46	8.0	8.0	8.0
APC-47	8.0	8.0	8.0
APC-48	8.0	8.0	8.0
APC-49	8.0	8.0	8.0
APC-50	8.0	8.0	8.0
APC-51	8.0	8.0	8.0
APC-52	8.0	8.0	8.0
APC-53	8.0	8.0	8.0
APC-54	8.0	8.0	8.0
APC-55	8.0	8.0	8.0
APC-56	8.0	8.0	8.0
APC-57	8.0	8.0	8.0
APC-58	8.0	8.0	8.0
APC-59	8.0	8.0	8.0
APC-60	8.0	8.0	8.0
APC-61	8.0	8.0	8.0
APC-62	8.0	8.0	8.0
APC-63	8.0	8.0	8.0
APC-64	8.0	8.0	8.0
APC-65	8.0	8.0	8.0
APC-66	8.0	8.0	8.0
APC-67	8.0	8.0	8.0
APC-68	8.0	8.0	8.0
APC-69	8.0	8.0	8.0
APC-70	8.0	8.0	8.0
APC-71	8.0	8.0	8.0
APC-72	8.0	8.0	8.0
APC-73	8.0	8.0	8.0
APC-74	8.0	8.0	8.0
APC-75	8.0	8.0	8.0
APC-76	8.0	8.0	8.0
APC-77	8.0	8.0	8.0
APC-78	8.0	8.0	8.0
APC-79	8.0	8.0	8.0
APC-80	8.0	8.0	8.0
APC-81	8.0	8.0	8.0
APC-82	8.0	8.0	8.0
APC-83	8.0	8.0	8.0
APC-84	8.0	8.0	8.0
APC-85	8.0	8.0	8.0
APC-86	8.0	8.0	8.0
APC-87	8.0	8.0	8.0
APC-88	8.0	8.0	8.0
APC-89	8.0	8.0	8.0
APC-90	8.0	8.0	8.0
APC-91	8.0	8.0	8.0
APC-92	8.0	8.0	8.0
APC-93	8.0	8.0	8.0
APC-94	8.0	8.0	8.0
APC-95	8.0	8.0	8.0
APC-96	8.0	8.0	8.0
APC-97	8.0	8.0	8.0
APC-98	8.0	8.0	8.0
APC-99	8.0	8.0	8.0
APC-100	8.0	8.0	8.0

Custom configurations

Before you can record data, you must first ensure that the cytometer configuration is appropriate for the experiment. If needed, you can create custom configurations to add parameters or filters and mirrors that are not listed in the base configuration. You will also need to create custom configurations for each sheath pressure you would like to run.

When creating custom configurations, use descriptive names that make it easy to identify the configuration. See the *BD FACSDiva™ Software Reference Manual* and the *BD Cytometer Setup and Tracking Application Guide* for more information.

Preparing for custom configurations

Custom configurations can be created only by users with administrator access. The easiest way to create a custom configuration is to copy and edit a base configuration. You can also create a new, blank configuration.

1. Log in to the software as an administrator.
2. Select **Sort > Sort Setup** and select the setup mode that matches the nozzle size you are using.
3. Verify that the correct nozzle is installed, then start the stream.
4. Select **Cytometer > CST**.

The **Cytometer Configuration** window opens (see [Cytometer configuration \(page 59\)](#)). For users with administrator access, the window displays the Parameters and Filters and Mirrors tabs, which are not visible to users with operator access.

When you create a new configuration in CS&T, you need to run a new baseline for that configuration. Once the baseline is established, you cannot edit any of the settings in the configuration.

Adding parameters, filters, and mirrors

Before creating a custom configuration, verify that the necessary parameters, filters, and mirrors required for the custom configuration are defined.

1. To add new parameters, do the following in the **Parameters** tab:
 - a. Click **Add**.
 - b. Enter a parameter name in the field provided.

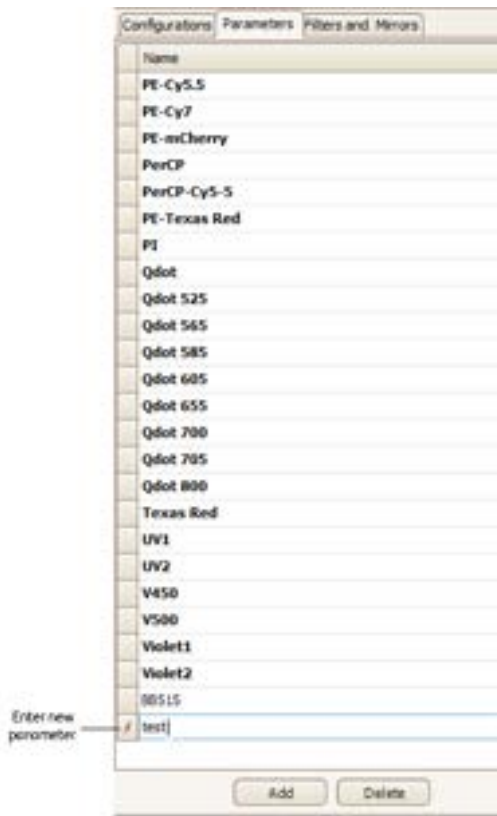

- 2. To add filters or mirrors, do the following in the **Filters and Mirrors** tab:
 - a. To add a filter, click **Add** under the Filter list. To add a mirror, click **Add** under the Mirror list.

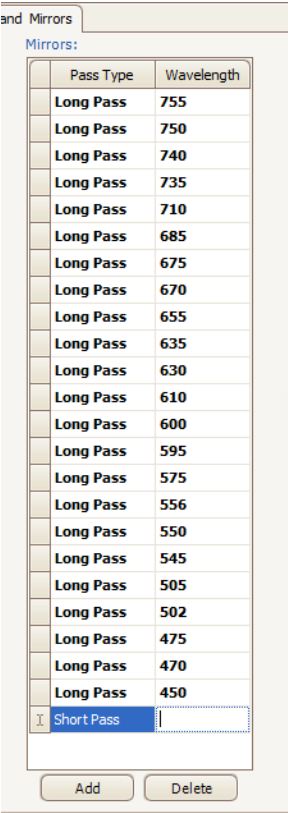

- b. Select a pass type and enter a wavelength in the field provided.

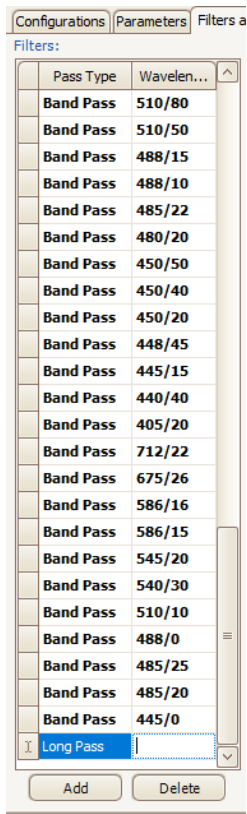

Copying a base configuration

You cannot edit or delete your base configuration. However, you can use it as a starting point to create a custom configuration.

1. In the **Configurations** tab, right-click the **Base Configurations** folder and select **New Folder**.
2. Rename the new folder *Custom Configurations*.
3. Right-click the base configuration and select **Copy**.

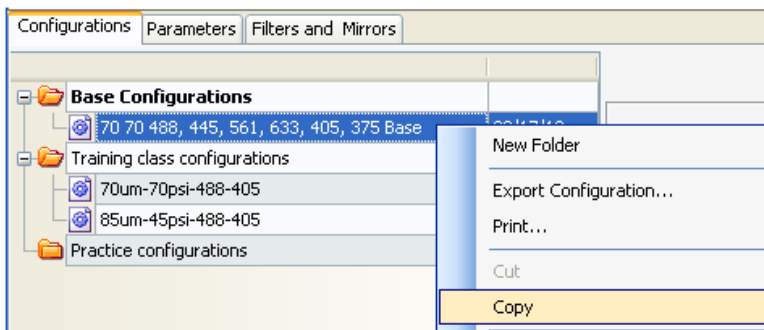

4. Right-click the **Custom Configurations** folder and select **Paste**.
A copy of the base configuration is added to the Custom Configurations folder.

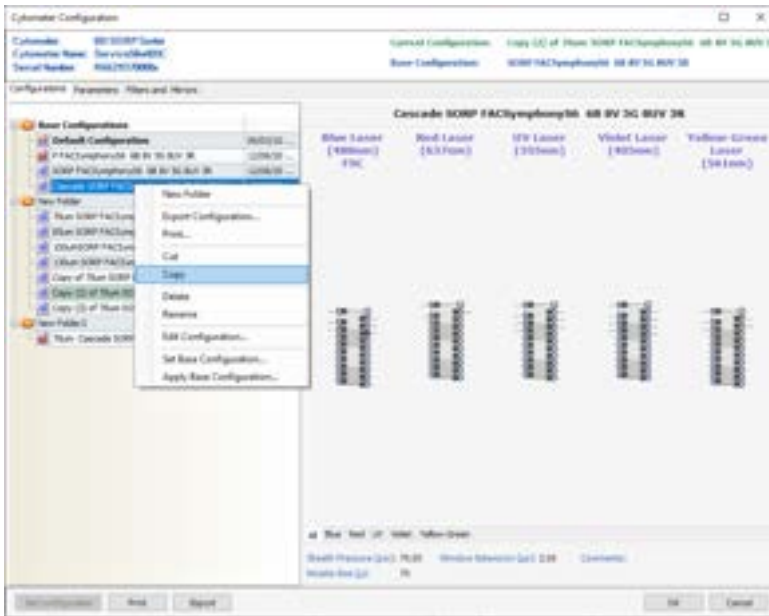

5. Enter a descriptive name and press **Enter**.

For example, use the name *70-70*, meaning 70-micron nozzle at 70 PSI. If you need to rename the configuration, right-click the new configuration and select **Rename**.

Editing the copied configuration

Once the base configuration is copied, you can customize the parameters, filters, and mirrors in the configuration.

1. In the configuration list, right-click the new configuration and select **Edit Configuration**.

The following window opens.

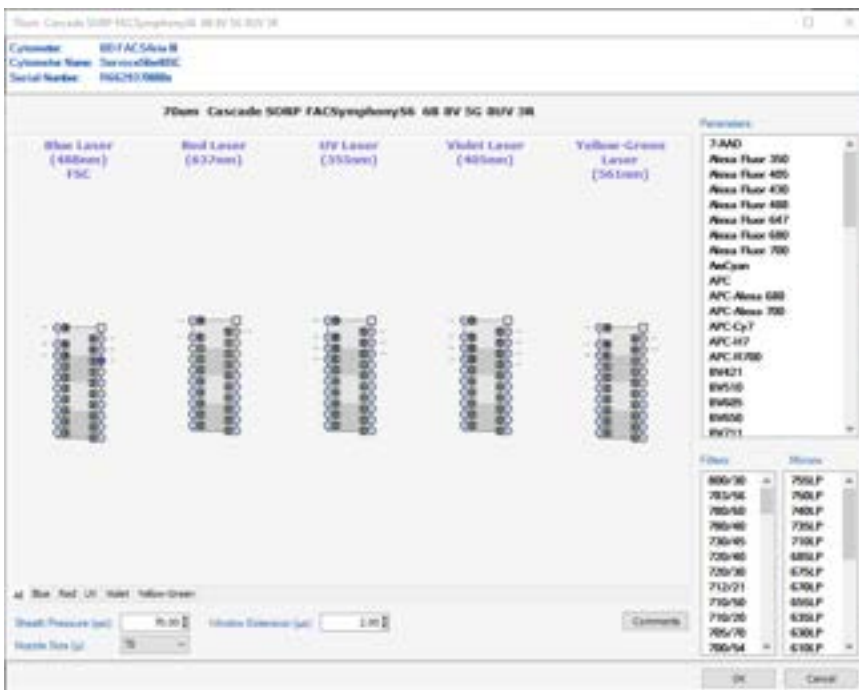

Use the tabs at the bottom of the window to view each laser's detectors separately. The following is an example when the **Blue** tab is selected:



2. To edit the nozzle size and sheath pressure for this configuration:
 - a. Enter the appropriate sheath pressure value at the bottom of the configuration window.
 - b. Select the appropriate nozzle size.

Sheath Pressure (psi): Window Extension (µs):

Nozzle Size (µ):

3. To change the parameter label for a detector, select a parameter from the **Parameters** list and then drag and drop the parameter onto a detector (one of the discs labeled A-H) for the appropriate laser. You can assign multiple parameters by using **Ctrl+click** to select individual parameters or **Shift+click** to select a contiguous range.
4. To change a filter, drag and drop a filter in the **Filter** list menu onto a detector, as in step 3.

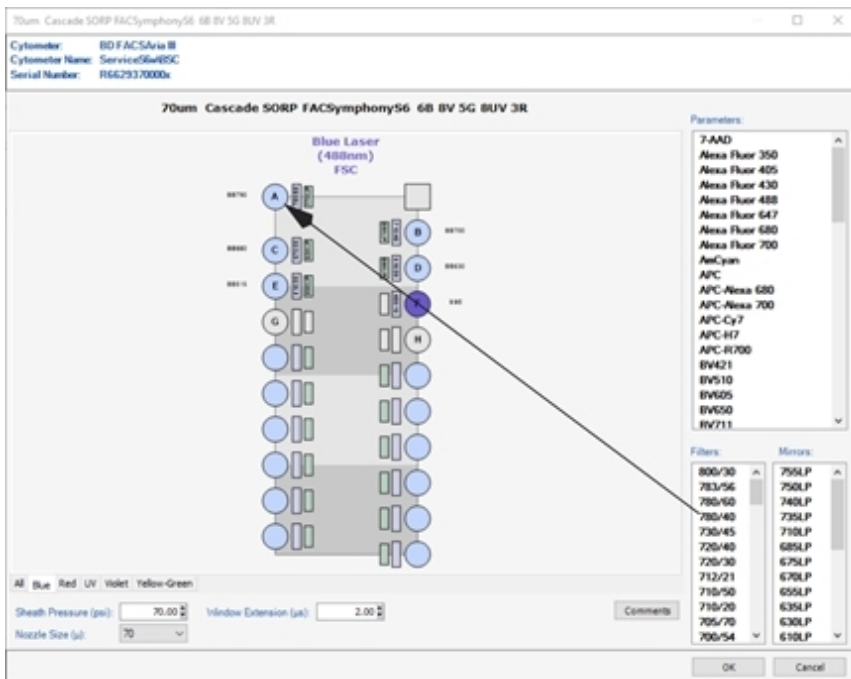

- To change a mirror, drag and drop an item in the **Mirror** list for that detector onto a detector, as in step 3.

To verify that you have selected the correct configuration, do the following.

- Select **Cytometer > CST**.
- Select the appropriate configuration and select **Set Configuration**.
- Select **File > Exit** to exit CS&T.
A mismatch dialog is displayed.
- Select **Details**, and then select **Use CST Settings**.

Verifying that the configuration matches the sort setup

To verify that the sheath pressure in the sort setup matches the sheath pressure in the configuration:

- Select **File > Exit** to exit CS&T.
- Select **Sort > Sort Setup**, and select the sort setup that matches the nozzle size listed in your configuration.

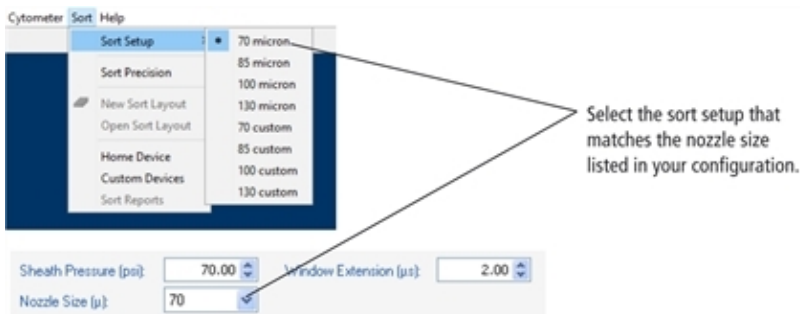

- Select **Cytometer > Sheath Pressure** and verify that the pressure matches the pressure in your configuration. Enter a new sheath pressure, if needed.
The new sheath pressure is automatically saved with the current sort setup mode.

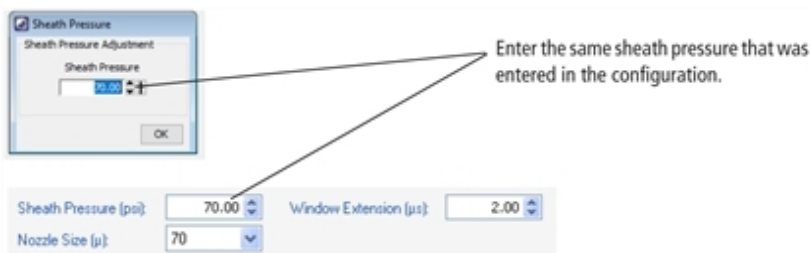

The name of the configuration is displayed at the top of the BD FACSDiva™ workspace. If you use a descriptive name for each configuration (such as *100-15-Custom*, for nozzle size-sheath pressure-sort setup mode), it will be easier to verify that the appropriate settings match without going back to view the configuration.

Acquisition controls

Along with the controls described in the *BD FACSDiva™ Software Reference Manual*, the following acquisition controls are available for the BD FACSymphony™ S6 cell sorter cytometer.

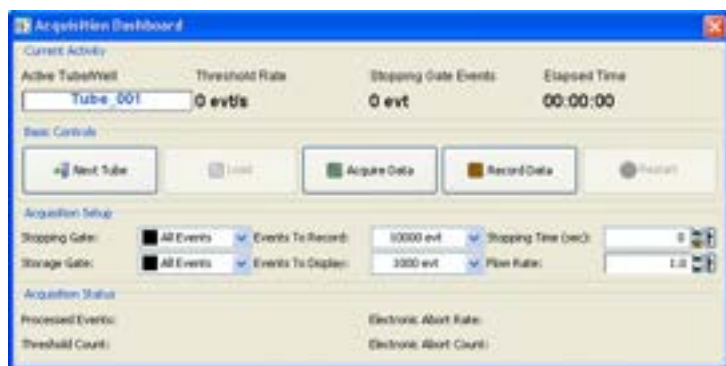

- **Load.** Lifts a tube into the sample injection chamber, starts sample agitation (if agitation is turned on), and starts acquisition of the sample.

When a tube is already loaded, the button changes to Unload. Clicking Unload stops acquisition of the sample, turns off the agitator, and lowers the tube from the sample injection chamber.

Note: The Load button is enabled only when the workstation is connected to the cytometer, an experiment is open, the stream is turned on, and the current tube pointer is set to a tube.

- **Stop Acquiring.** Stops sample acquisition without unloading the sample tube.

The Acquire Data button functions only when a tube is loaded.

- **Flow Rate.** Controls sample flow rate, from 1.0–11.0 (10–80 $\mu\text{L}/\text{min}$).

Do one of the following to change the flow rate:

- Select the value in the field and enter a new value.
- Click the pointer in the slider bar and drag it to a new value.
- Use the mouse to click the up and down arrows or press the arrow keys on your keyboard to increase or decrease the values in small increments.

Sorting controls

All sorting on the BD FACSymphony™ S6 cell sorter cytometer is controlled by BD FACSDiva™ software. See the table after the following figure for explanations of each area.

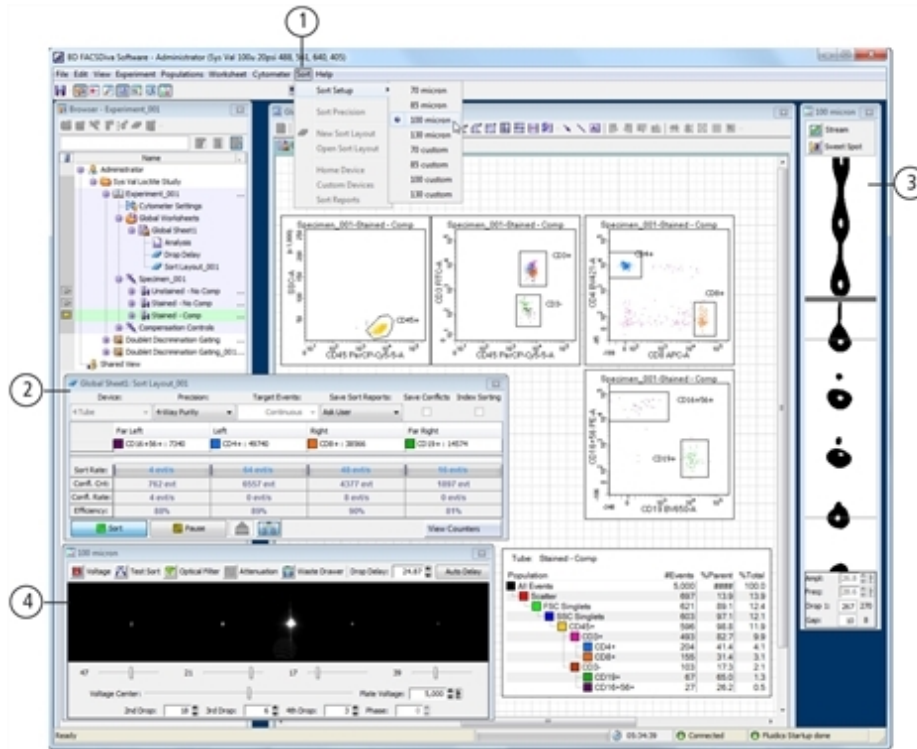

No.	Description
①	The Sort menu provides access to the sort setup and sort precision modes, sort layouts, sort reports, and sort devices used with the ACDU unit. See Sort menu (page 69).
②	The Sort Layout window contains controls to turn on index sorting and designates which device will be used to collect sorted particles and which particles will be sorted into each sort location. Depending on your system's configuration, your setup values may vary.
③	The Breakoff window displays an image of the stream and contains controls to adjust drop formation. See Drop Formation (page 43).
④	The Side Stream window displays an image of the side streams, and contains controls to adjust electrical charges and the drop delay. See Side Stream Formation (page 47).

Sort menu

Select commands in the Sort menu for the following:

- **Sort Setup.** Downloads the most recently used settings for the selected nozzle size. See [Sort setup](#) (page 70).
- **Sort Precision.** Opens a dialog where you can select or define a sort precision mode for handling sorting conflicts. See [Conflict Resolution During Sorting](#) (page 50).

- **New Sort Layout.** Opens the default 2-Tube Sort Layout window where other sort layouts can be selected. (Clicking the **Sort Layout** button on the **Browser** toolbar performs the same function.)
- **Open Sort Layout.** Opens an existing sort layout. A sort layout must be selected in the Browser for this menu command to be enabled. Alternatively, double-click any sort layout to open it.
- **Home Device.** Opens a dialog containing commands to move the tray support arm, either manually or to the home position. See [Setting up the stream \(page 133\)](#).
- **Custom Devices.** Opens a dialog where custom devices can be defined. See [Creating a custom device \(page 135\)](#).
- **Sort Report.** Displays a report showing the sort settings, acquisition counters, and sort layout information from the current sort. See [Sort report \(page 75\)](#).

Sort setup

Sort setup values for four different nozzle sizes can be downloaded using the **Sort > Sort Setup** command. Default settings are provided for each sorting option, along with a custom setting for each option.

As a general rule, for optimal results when sorting large or fragile cells, use a larger nozzle size and lower pressure. To increase throughput and yield when sorting smaller or less fragile cells, use a smaller nozzle size and higher pressure.

Sort Setup Name	Nozzle (microns)	Default Pressure (PSI)
70 micron	70	70
85 micron	85	45
100 micron	100	20
130 micron	130	10

If you make changes to any of the settings, the changes are automatically saved when you exit BD FACSDiva™ software or when you switch to a different sort setup mode. When you restart, the most recently used set of values is restored.

In addition, the Sort Setup menu has following menu items: 70 Custom, 85 Custom, 100 Custom, and 130 Custom. Initially, all of these new setups are exact copies of the corresponding original setups with the same defaults. This allows you to create two sets of sort values (pressure, for example) for the same nozzle size.



Do not use a nozzle size that is different from the sort setup setting. The gap values and sensitivity algorithms are optimized for particular nozzles and are not suitable for other nozzle sizes. The system performance could be unstable.

The following table shows default sort setup values. Depending on your system's configurations, your setup values may vary. We recommend optimizing these settings for your system's configurations.

Setting	70 micron	85 micron	100 micron	130 micron
Sheath pressure	70	45	20	10
Amplitude	60	32	12	24
Frequency	87	47	30	12
Drop 1	150	150	150	150
Gap (upper limit)	6 (14)	7 (17)	10 (21)	12 (21)
Attenuation	Off	Off	Off	Off
Drop delay	47.00	30.00	27.00	16.00
Far left voltage	100*	100*	80	60
Left voltage	70	35	30	20
Near left voltage	30	35	30	20
Near right voltage	30	35	30	20
Right voltage	70	35	30	20
Far right voltage	100*	100*	80	60
Plate voltage	6,000	6,000	4,500	4,500
2nd drop	20	20	10	0
3rd drop	10	10	5	0
4th drop	0	0	0	0
Laser delay (blue)	0.00	0.00	0.00	0.00
Laser delay (red)	-40	-35	-40	-40
Laser delay (violet)	40	35	40	40
Laser delay (UV)	78	71	80	78
Laser delay (yellow green)	-80	-80	-80	-80
Area scaling (blue)	0.60	0.60	0.60	0.60
Area scaling (red)	0.60	0.60	0.60	0.60
Area scaling (violet)	0.60	0.60	0.60	0.60
Area scaling (UV)	0.60	0.60	0.60	0.60
Area scaling (yellow green)	0.80	0.80	0.90	0.95
Window extension	2.00	2.00	2.00	4.00

* For 3.5-inch deflection plates, the value needs to be set to 85 or less. Otherwise the plates may get wet, which could cause arcing.

The Sort Layout window contains all sorting instructions and controls. The sort layout designates which device will be used to collect sorted particles and which particles will be sorted into each sort location. Up to four sort counters can be displayed in the window to give ongoing status during a sort.

Only one sort layout can be open at a time, but you can create several layouts for a single tube, as long as each sort layout has a different name. Sort layouts can also be added to global worksheets.

Sort layouts are available for up to 12 default collection devices (shown in the following figure). Additional custom devices can be defined. See [Creating a custom device \(page 135\)](#).



Examples of sort layouts for different devices are shown in the following figures. Instructions for setting up a sort layout can be found in [Setting up a sort layout \(page 73\)](#).

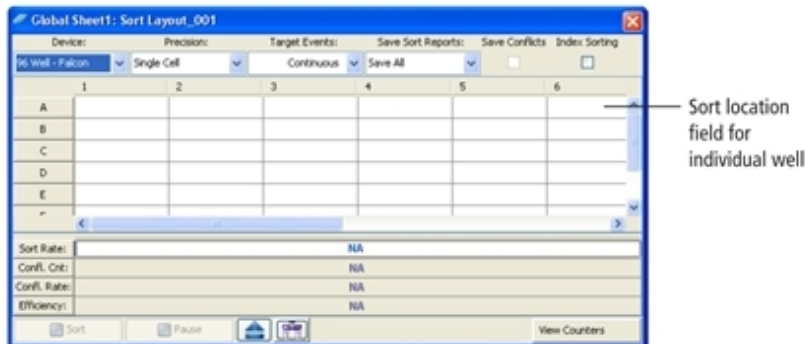
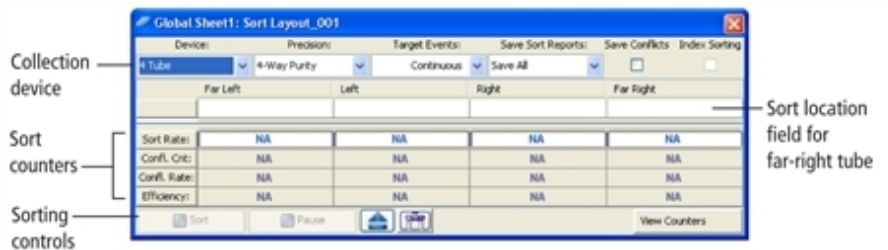

Setting up a sort layout

Sort layouts can be added to tubes or global worksheets.

- Create tube-specific layouts if you are sorting different populations or using different sort devices for each tube in the experiment.
- Create global worksheet-specific layouts if you are sorting the same populations into the same sort device for all tubes in the experiment.

Note: To create a tube-specific sort layout, make sure a normal worksheet (white tab) is shown in the Worksheet window before you create the layout.

To set up a sort layout:

1. Select the icon for a tube or global worksheet in an open experiment and click the **New Sort Layout** button on the **Browser** toolbar.

2. In the **Sort Layout** window, select the type of device from the **Device** menu.

Default sorting devices are listed along with any defined custom devices. The Sort Layout window changes depending on the selected device. The number of rows and columns in the window matches the number of tubes, wells, or spots in the collection device.

3. Select the sort precision mode from the **Precision** menu.

For more information, see [Sort Precision Modes \(page 52\)](#).

4. Enter the number of events to be sorted in the **Target Events** field.

Once entered, the number of events can be selected from the Target Events menu. For continuous sorting, select **Continuous** from the **Target Events** menu.

5. Select one of the following options from the **Save Sort Reports** menu:

- **Save None.** Sort reports are not saved.
- **Save All.** Automatically saves a sort report each time the sort is stopped.
- **Ask User.** Prompts the user each time the sort is stopped to select whether or not to save the sort report. This is the default option.

This setting is saved with the sort layout.

6. Select the field(s) corresponding to the tube(s), well(s), or spot(s) where the population will be sorted and select a defined population from the **Add** menu.

When you click in a sort location field, a menu opens allowing you to add, delete, or clear all populations in the field.



After you add a population, the population and the number of target events are added to the corresponding sort location field.

Note: Select a row or column header to select all fields in that row or column. When you add a population, it will be added to all selected fields at once.

- Specify whether to save sort conflicts by selecting the **Save Conflicts** checkbox. When selected, all sort conflicts are sorted into a default location.

- For a two-tube layout, conflicts are sorted to the right.

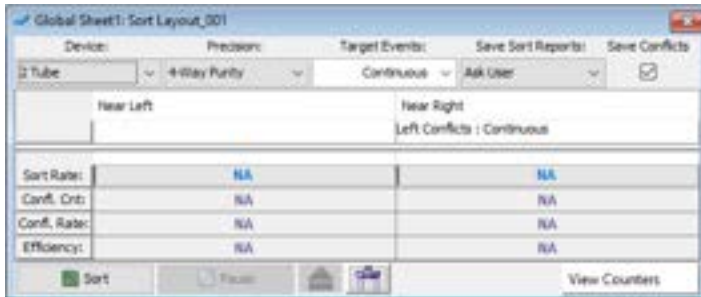

- For a four-tube layout, conflicts for the far left tube are sorted to the left, and conflicts for the far right tube are sorted to the right.

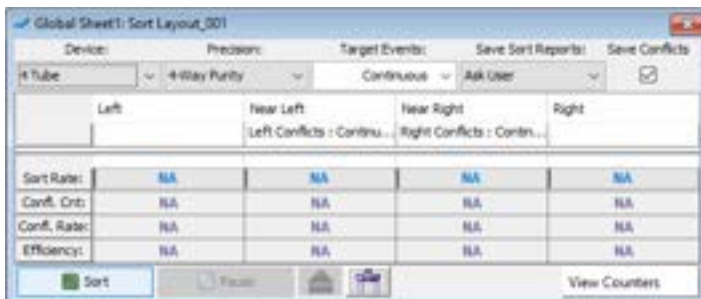

- Six-tube layouts do not support conflict sorting.

Editing a sort layout

- To change the number of events for any population, click in the **Sort Location** field(s) containing the population, then select a number from the **Target Events** menu or enter a new number.
- To remove a population from a sort location field, select the field, then select the corresponding population from the **Delete** menu.
- To clear all populations from a field, select the field, then select **Clear All**.

Using Sorting Controls

Sorting controls are located at the bottom of the Sort Layout window. Use these controls for the following functions.



- Sort.** Starts sorting events for the current acquisition tube. All counters reset to zero when this button is clicked. Events are sorted until the requested number of sorted events has been reached. Click the **Sort** button again to stop sorting before reaching the requested number of events. The counters stop at the number of sorted events. If you click **Sort** to restart sorting, the counters reset to zero.
- Pause/Resume.** Stops sorting, but not acquisition. Sort counters and sort timers freeze when the Pause button is clicked. Click the **Resume** button to continue sorting and to continue incrementing the sort counters and timers. See [Pausing and resuming a sort \(page 130\)](#).

- **Access Stage.** When the ACDU stage is in the back, the stage is moved forward to put a plate on or take a plate off the stage. When the stage is in the front, the stage is moved to the back and out of the way so you can install a collection tube holder.
- **Move Drawer.** Moves the aspirator drawer in (closed) or out (open) depending on its current state. The default state is in. For more information, see [Aspirator drawer \(page 21\)](#).

Using counters

Counters provide ongoing status during sorting. Counter fields cannot be edited. To display fewer counters in the Sort Layout window, click the **View Counters** button and select a menu option. The corresponding counter is hidden. (Only counters with a checkmark next to the name are displayed.)

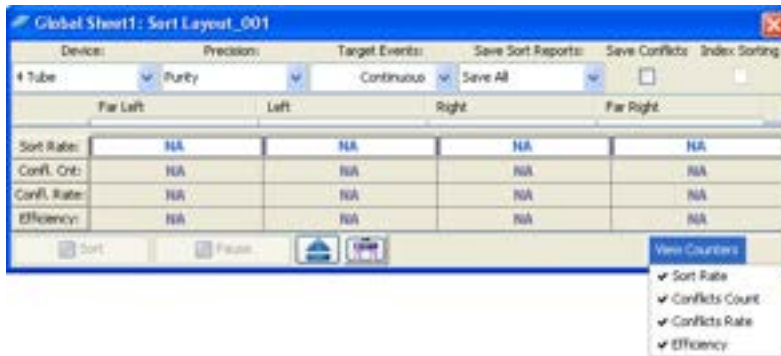

Counters display the following information:

- **Sort Rate.** Number of events per second that met the sort criteria and were sorted.
- **Conflict Count.** Number of events that met the sort criteria but were not sorted because of conflicts.
- **Conflict Rate.** Number of conflicts per second.
- **Efficiency.** Number of sorted events/(sort conflicts + sorted events) × 100.

Monitoring a sort

During sorting, each sort location field displays the number of actual sorted events. When a target number is specified, the field displays the actual number of events along with the number of target events.

A progress bar opens behind the sort rate counter field showing the progress of the sort.



Sort report

Select **Sort > Sort Reports** to view all of the saved reports for the current sort layout. A sort report can be printed or exported. The **Sort Reports** menu option is enabled if either of the following is true: a sort layout is

selected in the Browser (even if experiment is closed), or a sort layout is open. If both conditions are true, the Browser selection takes precedence.



A sort report contains the following:

- **Header information.** Experiment name, specimen name, tube name, sort layout name, software name and version, the date and time of printing, type of collection device, user ID, and cytometer.
- **Sort Settings.** Sort setup values, precision mode, mask definitions, etc.
- **Acquisition Counters.** Threshold count, processed events count, electronic conflicts count, and elapsed time.
- **Sort Counters.** Counter values per sort destination, or total sort count if sorting sequentially.
- **Sort Layout.** Population(s), sort count, and target event count for each sort location field.

Sort Settings				
Sort Setup	300 events	Precision	4-Hex Party	
Frequency	20.0	Tube Head	0	
Waveform	27.1	Pulse Head	0	
Phase	0.00	Phase Head	0	
Drive Filter	24.01	Single LSP	OFF	
Interlock	OFF	Phase Voltage	5.000	
Event Stop	ON	Voltage (Sampling)	0	
Pre-Stop	20.1	Sheath Pressure	30.00	
Target Gap	0			
Sorter Monitor Voltages (%)				
Far Left	Left	Right	Far Right	
47.00	21.00	17.00	38.00	
Reagent/Sorting Drop Change (%)				
2nd	3rd	4th		
18.00	6.00	3.00		
Acquisition Counters				
Threshold Count	200000			
Processed Events Count	200000			
Electronic Alerts Count	7672			
Sort Elapsed Time (min:sec)	00:20:47			
Sort Counters				
	Far Left	Left	Right	Far Right
Sort Count	0	0	0	0
Conflicts Count	0	0	0	0
Conflicts Rate	0	0	0	0
Efficiency	0	0	0	0
Sort Layout				
	Far Left	Left	Right	Far Right
	0200+00+1:0200	0200+0000	0200+0000	0200+12000

The Sort Report window contains a File menu where you can select to print or export the report. Exported comma-separated value (CSV) files can be opened with a spreadsheet application such as Microsoft® Excel®.

Reference line setup for digital cameras

For digital cameras, reference line adjustment is performed using the Reference Line Setup tab in the Cytometer window. This tab adds reference lines to the BD FACSDiva™ Side Stream window, providing a point of reference to center and align the sort streams into the collection devices.

Note: The Reference Line Setup tab is only present if the user is logged in as an Administrator.

Preliminary operations

Set up the cytometer for sorting with the appropriate nozzle configuration, breakoff, and BD FACSDiva™ software settings. Use the instructions given in the following sections:

1. [Starting the stream \(page 91\)](#)
2. [Setting up the breakoff \(page 92\)](#)
3. [Setting up for sorting \(page 120\)](#)

Selecting an existing sort device

The following procedure can only be performed by a user with Administrator privileges.

1. In the Cytometer window, select the **Reference Line Setup** tab.
2. Select a device from the Collection Device dropdown list.

The number of sliders displayed is device-dependent. For example, four slider controls for the **Four Tube** device, similar to the following :

Four Tube device



Six Tube device



3. Set up the reference lines as described in [Setting the reference lines \(page 78\)](#).

Creating a new sort device

The following procedure can only be performed by a user with Administrator privileges.

1. In the Cytometer window, select the **Reference Line Setup** tab.
2. From the Collection Device dropdown list, select **New Device**.

- Click the **New Device** button at the bottom of the window.

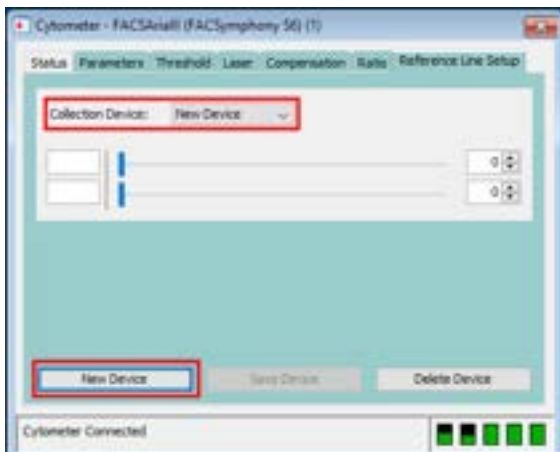

The software displays a New Deflection Device dialog:



- In the Device Name text box, type a system-unique device name as prompted.
If the device name already exists, the software will display a warning dialog, which can only be dismissed by clicking **OK**.
- In the Deflections dropdown list, select the number of sidestreams corresponding to the sort device.
- Click **OK** to close the dialog.
- Set up the reference lines and save the device settings as described in [Setting the reference lines \(page 78\)](#).

Setting the reference lines

Your BD Field Service Engineer (FSE) positioned the reference lines around the centered streams for BD-provided sort devices. Use this procedure if you want to readjust the reference lines in an existing device or to initialize the values in a new device.

Note: For existing devices, this correction is only necessary if aligning the streams to the reference lines places the streams off center of the actual sort collection device. The procedure can only be performed by a user with Administrator privileges.



Cell sorters that use droplet generation methods, such as the BD FACSymphony™ S6 cell sorter, can produce aerosols around the sample stream. When acquiring biohazardous samples, follow universal precautions at all times. Keep the sort block door and the sort collection chamber door closed during sorting.



You might need to raise the sash of the biosafety cabinet (BSC) above the safe-access opening of 8 inches to do this procedure.

1. Ensure that the appropriate collection device is selected on the **Reference Line Setup** tab of the Cytometer window—see [Selecting an existing sort device \(page 77\)](#) or [Creating a new sort device \(page 77\)](#). Reference lines corresponding to the selected collection device will display in the Side Stream window.
2. Before aligning the Side Stream reference lines, verify that the aspirator reference lines are centered around the stream. If necessary, align the stream to the aspirator reference lines by adjusting the sort block position.
3. Insert the sort collection device under the sort block with tape or lids covering tubes.
4. Perform a one-drop test sort:
 - a. Turn on the high-voltage plates.
 - b. Open the waste drawer.
 - c. Click **Test Sort** once to simultaneously deposit a drop for each side stream and then quickly click the button again to turn it off.

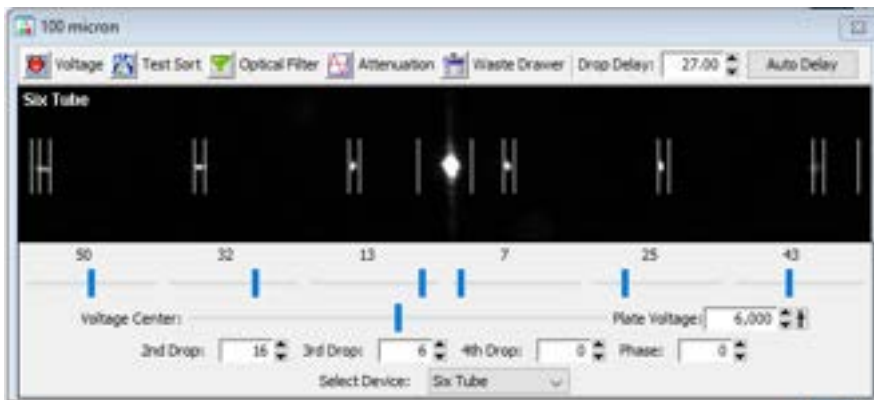

5. Remove the sort collection device and check whether each drop deposited is centered on the collection tube. If not, adjust the voltage slider for each stream to the appropriate setting. Re-insert the sort collection device and repeat the preceding step until all side streams are centered.
6. Close the waste drawer and click **Test Sort** to start the test-sort operation..
7. On the **Reference Line Setup** tab of the Cytometer window, adjust the sliders to center the collection device reference lines around each corresponding side stream.
8. On the **Reference Line Setup** tab of the Cytometer window, click **Save Device**.
The software displays a Save Deflection Device dialog.
9. To confirm the save operation, click **Yes** or cancel the operation by clicking **No** or **Cancel**.
10. Click **Test Sort** to stop the test-sort operation.
11. Turn off the high-voltage plates.

Deleting a sort device

The following procedure can only be performed by a user with Administrator privileges.

1. In the Cytometer window, select the **Reference Line Setup** tab.
2. From the Collection Device dropdown list, select the sort device to be deleted.
3. Click **Delete Device**.

The software displays a Confirm dialog:



4. Click **OK** to complete the operation.

Sort alignment software for analog cameras

The Sort Alignment software adds functionality to BD FACSDiva™ software version 8.0 or later.

Note: The Sort Alignment software is only applicable to analog cameras.

Overview

The Sort Alignment software adds reference lines to the BD FACSDiva™ Side Stream window, providing a point of reference to center and align the sort streams into the collection devices. Your BD FSE installed the software and positioned the reference lines around the centered streams. The following figure shows the reference lines in the Side Stream window.

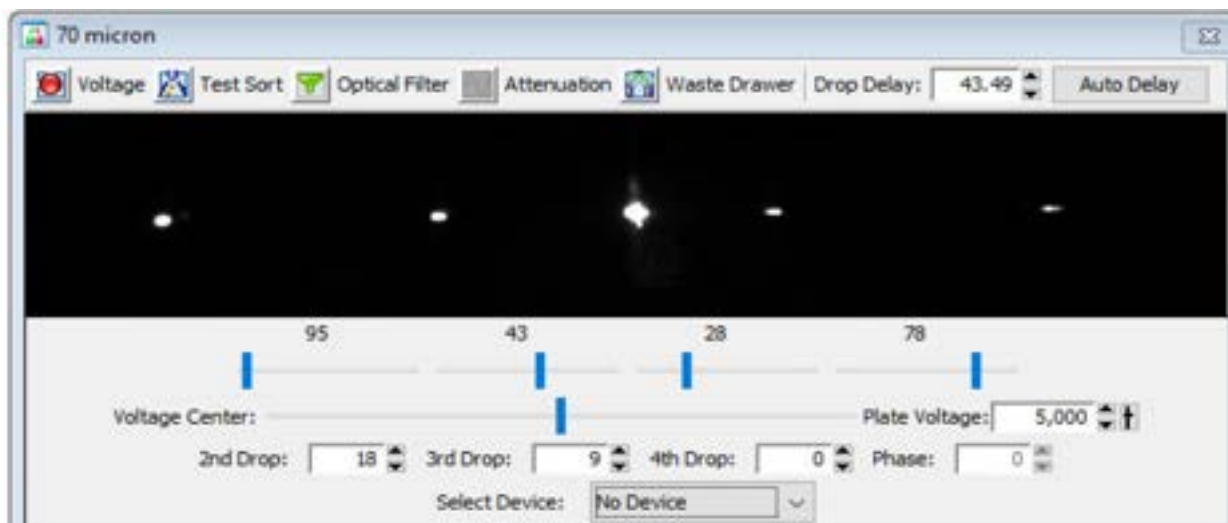

Aligning the streams



Cell sorters that use droplet generation methods, such as the BD FACSymphony™ S6 cell sorter, can produce aerosols around the sample stream. When acquiring biohazardous samples, follow universal precautions at all times. Keep the sort block door and the sort collection chamber door closed during sorting.

1. Set up the cytometer for sorting with the appropriate nozzle configuration, Breakoff, and BD FACSDiva™ software settings. Use the instructions given in the following sections:

- [Starting the stream \(page 91\)](#)
 - [Setting up the breakoff \(page 92\)](#)
 - [Setting up for sorting \(page 120\)](#)
2. Start the Sort Alignment software by clicking the icon in the Microsoft Windows taskbar located in the bottom left corner of the computer monitor.



This adds the Sort Alignment icon to the Notification area.

3. Click the Sort Alignment icon in the Notification area located in the bottom right corner of the computer monitor, and select your collection device from the menu that opens.



4. With the sort block door closed, use the Side Stream window to verify that the aspirator reference lines are centered around the stream. If necessary, align the stream to the aspirator reference lines by adjusting the sort block position.

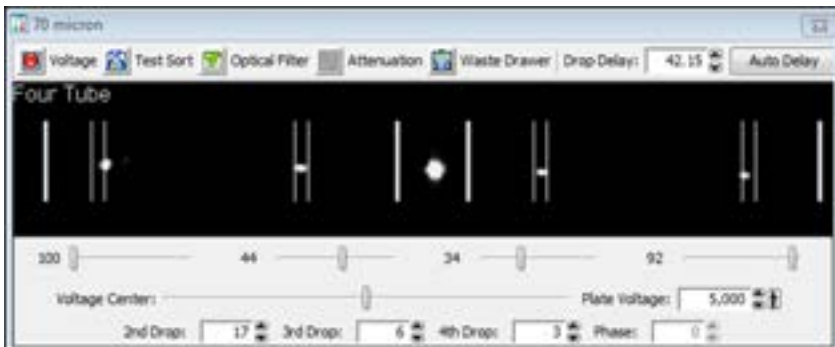

5. Align the side streams to the center of each of the collection device's reference lines by moving the voltage slider for each stream to the appropriate setting.
6. For more information on setting up the side streams, see the instructions given in [Setting up for bulk sorting \(page 120\)](#).

Setting the reference lines

Your BD FSE positioned the reference lines around the centered streams. If you want to readjust the reference lines, use this procedure.

Note: This correction is only necessary if aligning the streams to the reference lines places the streams off center of the actual sort collection device.



Cell sorters that use droplet generation methods, such as the BD FACSymphony™ S6 cell sorter, can produce aerosols around the sample stream. When acquiring biohazardous samples, follow universal precautions at all times. Keep the sort block door and the sort collection chamber door closed during sorting.



You might need to raise the sash of the biosafety cabinet (BSC) above the safe-access opening of 8 inches to do this procedure.

1. Make a backup copy of the existing BD FACSDiva™ sort alignment settings.

You can re-import them later, for example, after re-installing BD FACSDiva™ software. (Re-installing BD FACSDiva™ software deletes the settings.)

 - a. Navigate to C:\Program Files\BD FACSDiva Software.
 - b. Select the following .txt files:

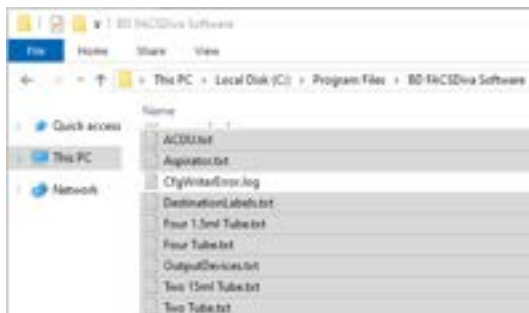

- c. Copy the files and paste them into C:\Libraries\Documents\BD Sort Alignment Tool.

Note: Create the directory if it does not exist.

2. Set up the cytometer for sorting.
3. Once the stream is centered to the aspirator drawer and the breakoff is set, turn on the Sweet Spot.
4. Navigate to C:\Program Files\BD FACSDiva Software\jarfiles, and double-click **SortDeviceControl.exe** to start the Sort Alignment software.

The Stream Aiming Device Setup window opens.



5. Select the appropriate collection device from the Device selection menu. Reference lines corresponding to the selected collection device will display in the Side Stream window.
6. Before aligning the Side Stream reference lines, verify that the aspirator reference lines are centered around the stream. If necessary, align the stream to the aspirator reference lines by adjusting the sort block position.
7. Insert the sort collection device under the sort block with tape or lids covering tubes.
8. Perform a one-drop test sort:
 - a. Turn on the high-voltage plates.
 - b. Open the waste drawer.
 - c. Click **Test Sort** once to simultaneously deposit a drop for each side stream and then quickly click the button again to turn it off.

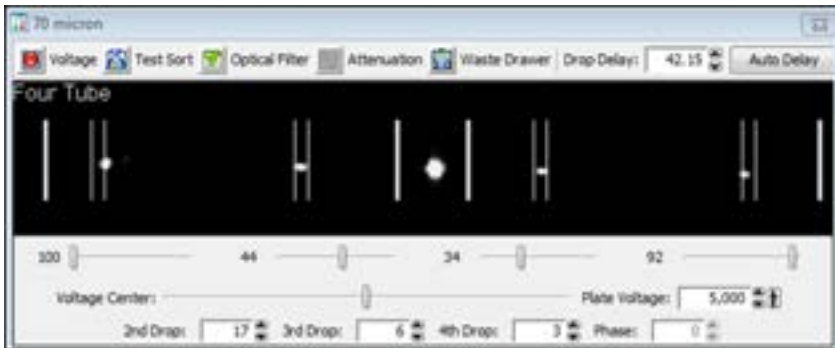

9. Remove the sort collection device and check whether each drop deposited is centered on the collection tube. If not, adjust the voltage slider for each stream to the appropriate setting. Re-insert the sort collection device and repeat the preceding step until all side streams are centered.
10. Close the waste drawer and click **Test Sort** to start the test-sort operation.
11. Use the Reference Line sliders to center the collection device reference lines around each corresponding side stream.

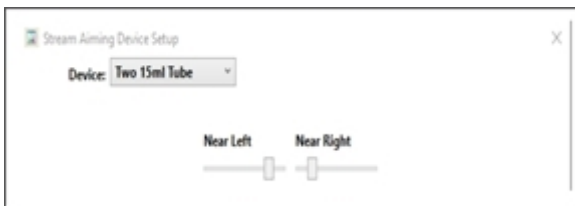

12. Click **Test Sort** to stop the test-sort operation.
13. Turn off the high-voltage plates.
14. Repeat steps 5–13 for each collection device configuration to be used.
15. Close the Sort Alignment software.

Reinstalling the Sort Alignment software

The Sort Alignment software is installed by your FSE. If you need to re-install the software, use this procedure.

1. Close BD FACSDiva™ software if it is open.
2. Navigate to C:\Program Files\BD FACSDiva Software\jarfiles.
3. Double-click **IconSortDeviceControl.exe** to start the application.

The Sort Alignment icon is displayed in the Windows taskbar and the systems tray.



Note: When starting the Sort Alignment software for the first time, the Sort Alignment icon might be displayed in the hidden area of the systems tray. If this occurs, drag the icon onto the systems tray.

4. Right-click the Sort Alignment icon in the Windows taskbar, and select Pin this program to taskbar from the menu that opens.

5. From the Windows Start menu, select **Settings**. On the Windows Settings screen select **Personalization** -> **Taskbar**. On the right pane, in the Notification area section, click **Select which icons appear on the taskbar**.

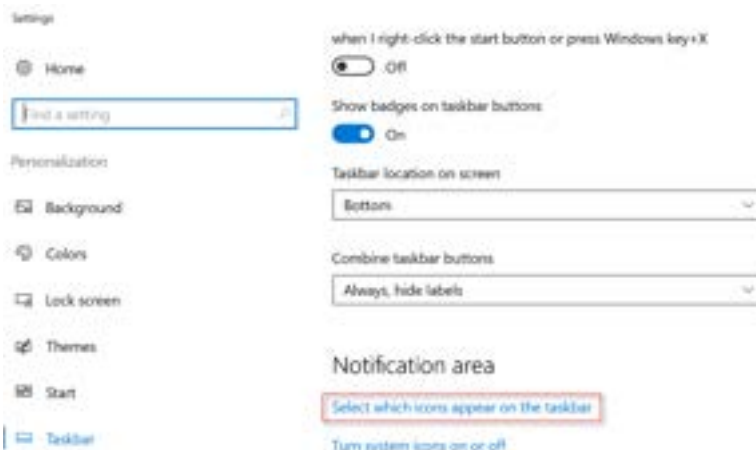

6. Ensure that you turn OFF the button for “Always show all icons in the notification area” and turn ON the button for “IconSortDeviceControl”.

Select which icons appear on the taskbar

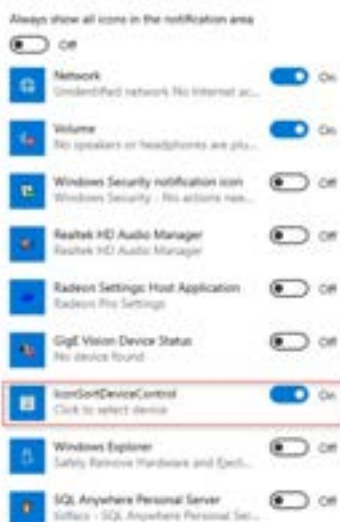

7. Navigate to [Aligning the streams \(page 80\)](#) for how to use the software.

Troubleshooting

Observation	Possible cause	Recommended solution
The aspirator reference lines are off-center	The side stream window camera needs realignment	Call BD customer service.
The sort alignment settings are gone	BD FACSDiva™ software was reinstalled	Reposition the digital reference lines. See Setting the reference lines (page 81)

Templates

When you install BD FACSDiva™ software for the BD FACSymphony™ S6 cell sorter cytometer, the following additional experiment templates are installed in the BD Export\Templates directory:

- **Accudrop Drop Delay template.** Contains a single specimen and tube, a gated plot on a standard worksheet, and a predefined sort layout. This experiment is used for setting the drop delay during sorting as described in [Determining the drop delay – manual method \(page 123\)](#).

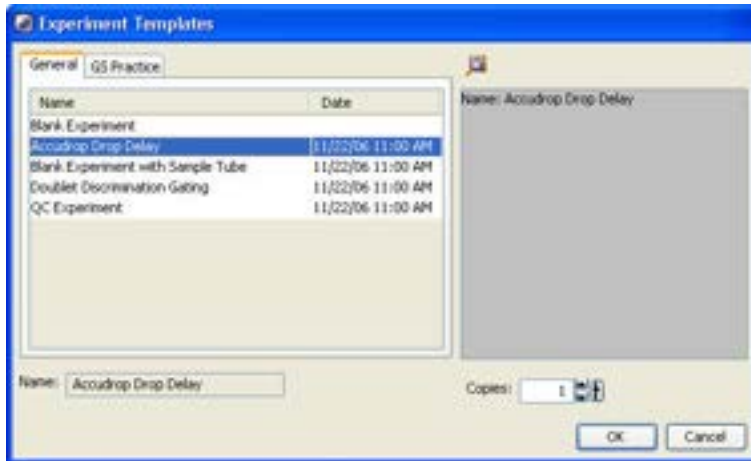

This page intentionally left blank

5

Startup and running samples

The following topics are covered in this chapter:

- [Cytometer startup \(page 88\)](#)
- [Checking cytometer performance \(page 99\)](#)
- [Application settings \(page 103\)](#)
- [Data collection \(page 108\)](#)
- [Data recording and analysis \(page 111\)](#)
- [Manual adjustment of laser delay \(page 116\)](#)

Cytometer startup

Follow these steps to start up your BD FACSymphony™ S6 cell sorter.

Note: Ensure that the instrument is plugged into the provided power conditioner and select proper voltage setting before turning on the main power.

1. Turn on the cytometer main power.

Power panel for cytometers with analog cameras:

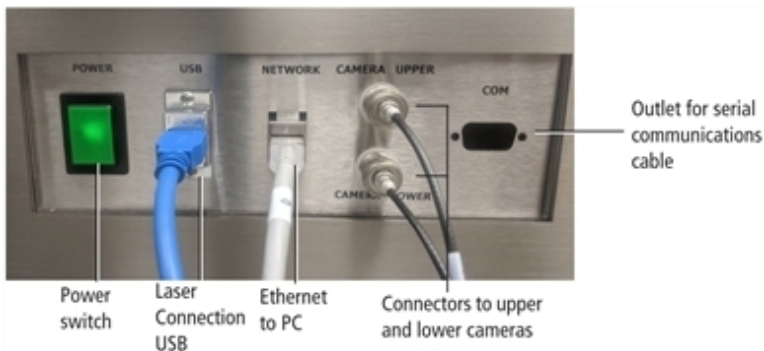

Power panel for cytometers with digital cameras:

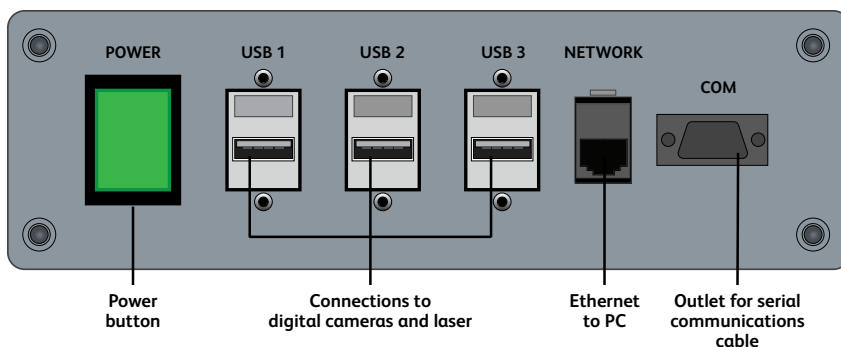

If the cytometer was just shut down, wait until the system is fully depressurized (stops hissing) before you turn on the main power.

2. Switch on the house air or the optional compressor.
3. Start up the workstation.
4. Press the LASER MAIN button on the front of the optics drawer to turn on the lasers you will be using. Wait 30 minutes for the lasers to warm up.
5. If your system includes the BSC and it is not already on, turn on the blower by pressing the power button on the Cabinet Controls panel.

A green light indicates the power is on.

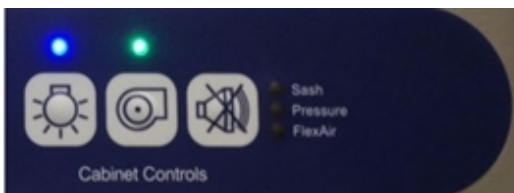

6. (Optional) If you are using the temperature control option, turn it on. See [BD FACSymphony™ S6 Temperature Control Option \(page 217\)](#).
7. Log in to Windows 10.
 - a. Select **BDOperator login** or **BDAdmin login**.
 - b. Type the password. On initial installation, the BDOperator password is **Welcome#1** and the **BDAdmin** password is **BDIS#1\$\$**. After logging in with the initial password, you will be prompted to change it immediately, and every 90 days thereafter.
8. Open the Coherent Connection laser control software, wait for all lasers to populate.
9. If the **Auto-on** laser option is selected, wait for all lasers controlled by Coherent Connection to power on. Otherwise, for each laser, select the **Laser Start** mode.

Note: The UV Laser does not turn on automatically, and will display in Coherent Connection in a “fault” state with power set to “0.00 mW”. If the laser is already in the **Laser Start** mode, select **Laser Stop**. Set the desired laser power, and then select **Laser Start**.

10. Ensure all lasers controlled by Coherent Connection are powered up and the power levels are stable. The laser power levels should automatically set to the previously used power levels. If not, adjust the power as needed.
11. Once all the lasers are at optimal power, close the Coherent Connection software to avoid laser connection issues with the BD FACSDiva™ software. Closing the Coherent Connection software will not affect the laser power levels.
12. For lasers not controlled through coherent connections software:
 - a. Open the GUI-VFL Laser-control software.



- b. Click the image of the serial (COM) port to view or set the port number.



- c. Enter the desired power level in the **Power Set** field, and select **Activate**.
 - d. Verify that the power level rises to the desired level.
 - e. Set the On/Off control to **On**.
13. Open BD FACSDiva™ software by double-clicking the application shortcut on the desktop.



14. Log in with your user name and password.

If your login name is not displayed, contact your BD FACSDiva™ software administrator to create a login name for you. For more information, see the *BD FACSDiva™ Software Reference Manual*.

15. Check the fluid levels in the **Cytometer** window. Replenish fluids or empty the waste, if needed.

To display the **Cytometer** window, click the **Cytometer** button on the **Workspace** toolbar. Check the fluid levels at the bottom of the window. Roll the mouse pointer over fluid indicators to show the fluid type.

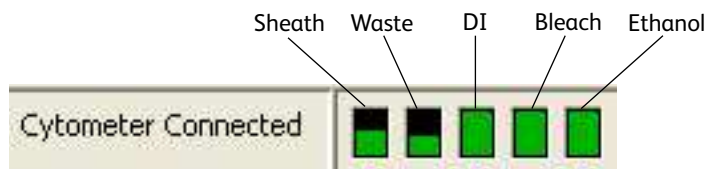

Note: The ethanol level in the Cytometer window indicates the volume of fluid in the white auxiliary ethanol tank. There is no sensor for the stainless steel ethanol shutdown tank.

To service the fluid containers, see [Emptying the waste tank \(page 97\)](#).

Performing fluidics startup

This section describes the fluidics startup procedure. The status of the fluidics system is displayed in the bottom right corner of the main window.

1. From the **BD FACSDiva™ Cytometer** menu, select **Fluidics Startup**. The following window opens.



2. Verify that the air and fluid lines are disconnected from the ethanol tank and connected to the sheath tank, then click **Done**.



Do not run fluidics startup with the air and fluid lines connected to the ethanol shutdown tank. This can cause damage to the system. Always verify that the lines are connected to the sheath tank.

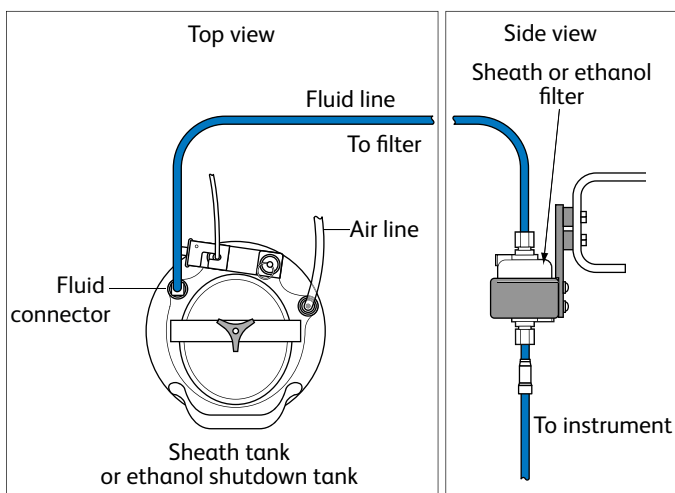

Note: The flow rate is calibrated with the sheath tank. If the location or elevation of the sheath tank is changed, it could affect the flow rate calibration.

3. As a precautionary measure, prior to opening the Flow Cell access door, use the **Stop** button in the laser control software to put the lasers in standby and then close the laser control software. This will turn off the laser diode, but will keep the diode temperature constant.
4. Open the Flow Cell door and verify that a closed-loop nozzle is installed in the flow cell, then click **Done**. The fluidics startup process starts and the progress is displayed at the bottom of the dialog.



5. Turn the nozzle-locking lever counter-clockwise to the 9:00 position, pull the closed-loop nozzle out of the cuvette flow cell, then click **Done**.
6. Insert the correct nozzle size in the flow cell.
 - a. Verify that the O-ring is present and that it is installed in the nozzle groove. For more information, see [Integrated nozzle \(page 19\)](#).
 - b. Make sure the top side of the nozzle is facing up as you insert the nozzle.
 - c. Push the nozzle all the way back into the flow cell.
 - d. Turn the nozzle-locking lever clockwise to the 12:00 position.
7. Click **OK** to complete the process.
8. Set the appropriate optical configuration. See [Cytometer configuration \(page 59\)](#).
9. When fluidics startup is complete, select **Sort > Sort Setup** and verify that the setup mode matches the nozzle size.
For information about Sort Setup modes, see [Sort setup \(page 70\)](#).

Starting the stream

1. Confirm that the in-house air pressure, or the compressor, is on.



When the stream is on, air pressure fluctuates between 80–100 PSI. A pressure reading of less than 80 PSI or greater than 100 PSI indicates that the fluidics are not functioning properly. If this occurs, contact your BD Biosciences service representative for assistance. Do not operate the cytometer outside the normal air pressure range.

2. Start the stream.
 3. a. Click the **Sorting** button on the **Workspace** toolbar to display the **Breakoff** and **Side Stream** windows.
 - b. Click the **Stream** button in the **Breakoff** window to turn on the stream.
4. Ensure that the lasers are off or in standby and the laser control software is closed.
5. Open the sort block door and check the stream.

The stream should flow smoothly from the nozzle into the center of the waste aspirator. If the stream is flowing but is unsteady, check for bubbles in the flow cell. If you see bubbles, turn off the stream, wait for 10 seconds, and turn on the stream again. If you see any dripping or spraying, or the stream image appears abnormal, turn off the stream and see [Troubleshooting the stream \(page 170\)](#).

- Close the sort block door.

Note: If you encounter bubbles in the sheath fluid stream at the 130-micron sort setting, perform a sample line backflush for approximately 1 minute. Select **Cytometer > Cleaning Modes > Sample Line Backflush**. To prevent bubbles, the sheath tank should be depressurized while not in use to prevent air from dissolving into the sheath solution.

- Close the Flow Cell access door and use the **Start** button in the laser control software to return the lasers to the Ready state.

Setting up the breakoff

Establishing a stable drop pattern in the breakoff window is an important step in getting optimal results from the system. See [Breakoff Window \(page 45\)](#) for more information on the parameters and controls in the breakoff window.

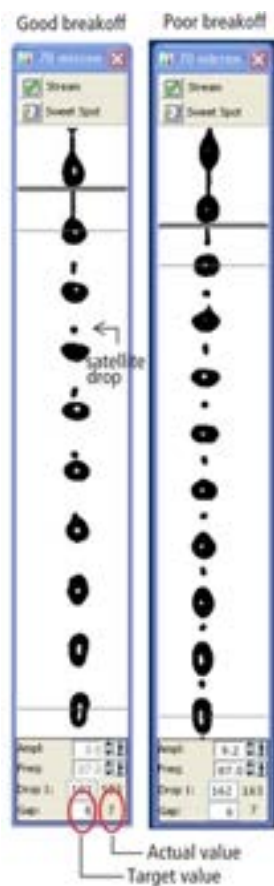

The following figure shows good versus poor breakoff patterns.



- Adjust the **Ampl** slider until the drop breakoff is approximately in the top third of the **Breakoff** window. Do not exceed 70 volts. If you cannot achieve a drop breakoff at <70 volts, do the following:
 - As a precautionary measure, prior to opening the Flow Cell access door, use the **Stop** button in the laser control software to put the lasers in standby and then close the laser control software. This will turn off the laser diode, but will keep the diode temperature constant.
 - Check the flow cell for air bubbles. If you see bubbles, turn the stream off and back on.

- Make sure the sheath pressure and drop-drive frequency are appropriate.
 - If the amplitude is <10 volts, turn on attenuation in the **Side Stream** window.
2. Verify that the small satellite droplets are merging with the large droplets.
If the satellites are not merging, you might need to clean the nozzle by sonicating. The satellite drops should merge into the drops in 6 satellites or fewer.
 3. Enter the actual Drop 1 value as the target in the **Drop 1** field.
The actual value is displayed in the gray background next to the Drop 1 field. Once a valid target has been established, you do not need to reset it unless you change the nozzle or your sort setup option.
Note: If the target value causes the amplitude to exceed 70 volts, perform the recommendations under step 1 and re-enter the Drop 1 target value.
 4. Turn on the Sweet Spot when the drop pattern is stable.
The Sweet Spot is designed to automatically adjust the drop-drive amplitude to maintain the stability of the breakoff point. When the Sweet Spot is on, the Amplitude and Frequency fields are disabled. The values are automatically adjusted by the software. For more information, see [Breakoff Window \(page 45\)](#).

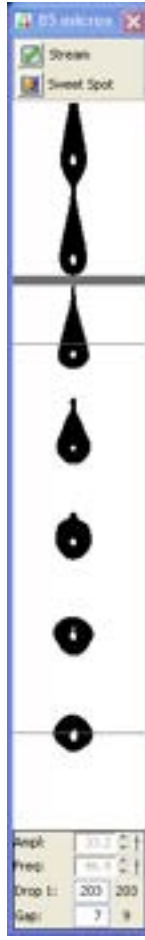
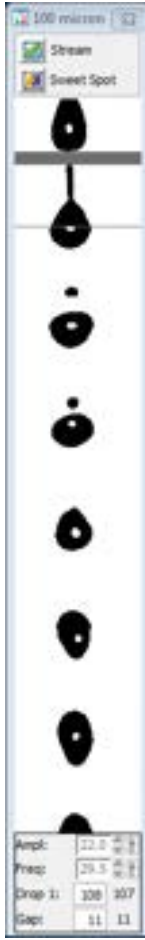
The breakoff patterns shown in the following table are intended as examples. The patterns will not always look exactly like these.

70 micron	85 micron	100 micron	130 micron
			

Setting up the fluidics

Check the fluid levels in the sheath tank and waste containers every time you use the cytometer. This ensures that you will not run out of sheath fluid during an experiment or have to service the containers during a sort. Fluid level indicators are shown in the Cytometer window in BD FACSDiva™ software.

If a fluid container is running low, refill it with the fluid indicated on the container label. For best results, fill the containers only with the fluids shown in the following table. For ordering information, see [Reagents \(page 189\)](#).

For instructions on emptying the waste, see [Emptying the waste tank \(page 97\)](#).

Container	Compatible Fluids	Capacity
Sheath ^a	<ul style="list-style-type: none"> BD FACFlow™ sheath fluid (non-sterile) 1X phosphate-buffered saline (PBS), with or without preservatives 	One 10-L stainless steel container
Ethanol Shutdown	70% solution diluted in deionized (DI) or laboratory-grade water	One 5-L stainless steel container
Bleach	<ul style="list-style-type: none"> 10% household bleach (0.5% sodium hypochlorite) BD FACSClean™ solution 	5 L
DI	Deionized water (Milli-Q or equivalent). Add 3 mL of bleach per liter of DI water.	5 L
Ethanol	70% solution diluted in DI or laboratory-grade water	5 L

Note: Make sure the blue sheath fluid line between the sheath tank and the cytometer does not come into contact with anything that could introduce vibration that might affect the stability of the stream.

Refilling the sheath tank

The fluid level in the pressurized stainless steel sheath tank should be checked often and refilled when low. The startup times for the breakoff stream will increase when the tank is low. If the cytometer is run until the sheath supply is too low, the system will turn off the stream.

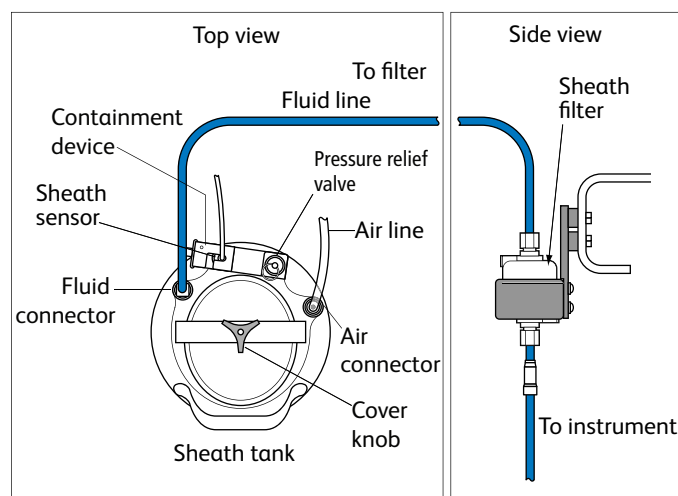

^aUsers should select solutions that are compatible with their specific samples and experiments.

To refill the sheath tank:

1. Turn off the stream.
2. Disconnect the air line.
3. Pull up on the ring of the pressure relief valve to release pressure from the tank.
Make sure the tank is fully vented.
4. Unscrew the sheath tank cover knob and remove the cover.
5. Fill the tank with sheath fluid up to the upper weld line on the inside of the tank. See the following figure.

Note: Do not overfill the sheath tank because this can cause incorrect sample flow rates.

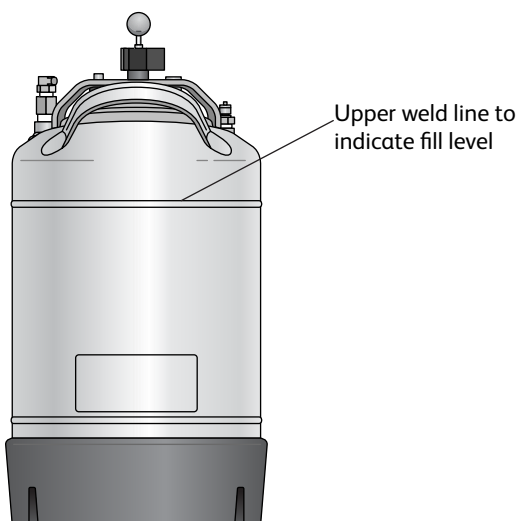

6. Replace the cover and tighten the knob.
Make sure the large O-ring on the inside lip of the cover is seated correctly and has not slipped out of position. The tank can leak if the cover is not secured properly.
7. If you removed the sheath tank to refill it, place the tank back in its original position.
The flow rate is calibrated with the sheath tank in the fluidics drawer. If the location or elevation of the sheath tank is changed, it could affect the flow rate calibration.
8. Connect the air line.
9. Close the vent release valve and use the sheath tank gauge to ensure the tank is pressurizing properly.
The system is ready to run again.

Refilling the ethanol shutdown tank

The fluid level in the stainless steel ethanol shutdown tank should be checked before starting the fluidics shutdown procedure and refilled when low. This tank does not have a sensor, so it must be checked manually.

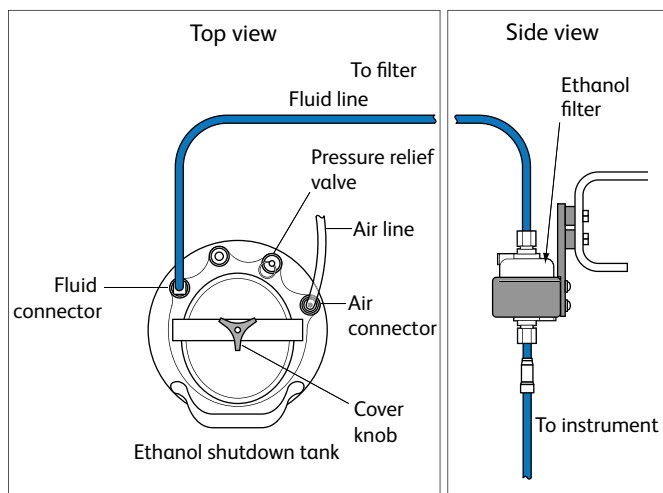

1. Turn off the stream.
2. If the air line on the ethanol shutdown tank is connected, disconnect it.
3. Pull up on the ring of the pressure relief valve to release pressure from the tank.
Make sure the tank is fully vented.
4. Unscrew the tank cover knob and remove the cover.
5. Fill the tank with ethanol to the level shown in the figure following this procedure.
6. Replace the cover and tighten the knob.
Make sure the large O-ring on the inside of the cover is seated correctly and has not slipped out of position.
The tank can leak if the cover is not secured properly.
7. If you are going to perform fluidics shutdown, connect the air line.

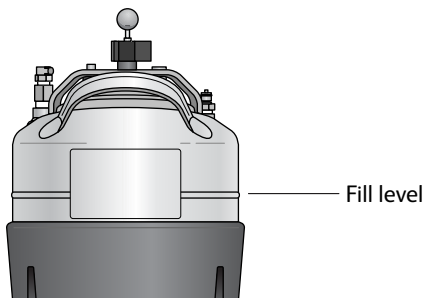

Refilling the plastic containers

You can refill the plastic containers directly in the fluidics drawer without detaching any lines, or you can remove the container for refilling.

Note: During operation, you can add fluid to a container through the large cap without any interruption to your experiment, but if you detach any lines, you will need to prime the system.

1. (Optional) Disconnect the container's sensor and quick-release connector from the connectors panel if you need to move the container.

If you do not need to move the container, skip to step 2.

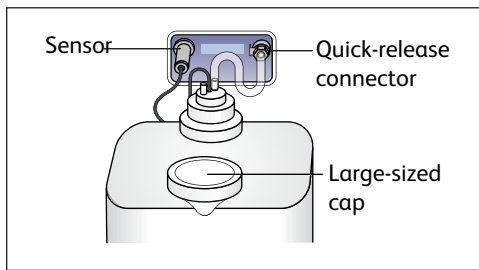

2. Remove the large-sized cap from the container.
3. Fill the container with the fluid indicated on the container label.
4. Replace the container cap and hand-tighten it until it is fully closed.
5. If you disconnected the sensor and quick-release connectors in step 1:
 - a. Reconnect the sensor and quick-release connectors to their respective ports.



To ensure that the appropriate solutions are dispensed, do not switch the tank positions. Make sure the label on each container matches the labeled port on the fluidics drawer.

- b. Prime the fluidics system.

From the BD FACSDiva™ menu bar, select **Cytometer > Cleaning Modes > Prime after Tank Refill**. In the dialog that opens, select the fluid to prime, then click **OK**.

Emptying the waste tank

Empty the waste tank daily and when the fluid indicator shows the waste is getting full. To prolong the life of the tank, we recommend that you switch to an alternate tank each time the waste is emptied.



All biological specimens and materials coming into contact with them can transmit potentially fatal disease. To prevent exposure to biohazardous agents, expose waste tank contents to bleach (10% of total volume) before disposal. Dispose of waste in accordance with local regulations. Use proper precautions and wear suitable protective clothing, eyewear, and gloves.



Change the waste tank cap and baffle every month, or when it has gotten wet, to prevent container pressurization. To order new replacement caps and baffles, contact your local BD Biosciences representative.

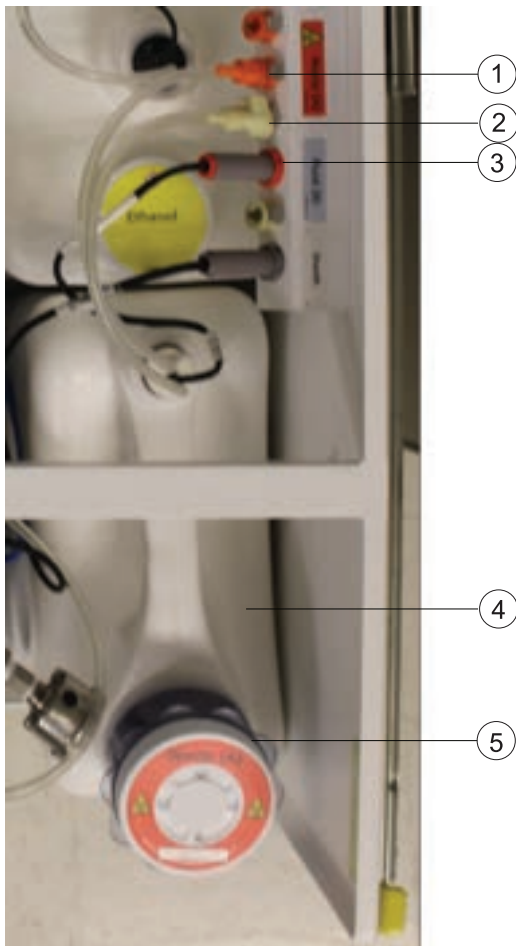

Item Number	Component
1	Waste fluid line
2	Waste air line
3	Waste sensor
4	Waste tank
5	Waste cap and baffle

1. Disconnect the waste tank's sensor and fluid line connectors from the connector panel in the fluidics drawer.



The waste tank can become pressurized when the cytometer is running. Always disconnect the tank from the connector panel before you empty it. Wait at least 1 minute for pressure to dissipate before you open the tank.

2. Remove the disposable waste cap (large-sized cap) and attached baffle from the container. Place the assembly on the bench label-side up.



Do not wet the cap on top of the baffle. If you see liquid inside the baffle, replace the cap and baffle with new components.

3. Empty the waste tank according to your standard laboratory procedures for biohazardous waste.
4. Add approximately 1 L of bleach to the waste tank (10-L container).
Add a sufficient amount so that 10% of the total waste volume is bleach.
5. Replace the waste baffle and attached filter cap. Hand-tighten the trap and cap until they are fully closed.



To prevent over-pressurization during fluidics startup, do not overtighten the baffle or attached filter cap. Tighten each component only until it is hand-tight. Do not use sealants such as Teflon® tape or other adhesives.

6. If one month has passed since you last changed the cap, replace the filter cap and baffle with new ones. Write the date on the new cap as a reminder.



7. Reconnect the sensor and fluid line connectors to their respective ports.

Checking cytometer performance

Before setting up an experiment, you should first run a performance check. A performance check ensures that the cytometer is performing consistently over time. It also generates default cytometer settings that places each PMT within an optimal range.

To run a performance check, start the BD® CS&T Research Beads application within BD FACSDiva™ software and select the appropriate cytometer configuration. Each configuration must have a valid baseline. See the *BD® Cytometer Setup and Tracking Application Guide* for more information on running a baseline.

Preparing the BD® CS&T Research Beads workspace

To ensure that your cytometer is performing consistently over time, it's important to keep as many variables constant as possible, such as bead type, sheath pressure, and cytometer settings. For this reason, you should run the daily performance check using the same cytometer configuration each day.

1. Turn off the Sweet Spot (if it is on), then select **Cytometer > CST**.

The cytometer disconnects from the BD FACSDiva™ interface and connects to the BD® CS&T Research Beads interface. A window similar to the following figure opens.

Note: Do not run the CST program in a maximized window.

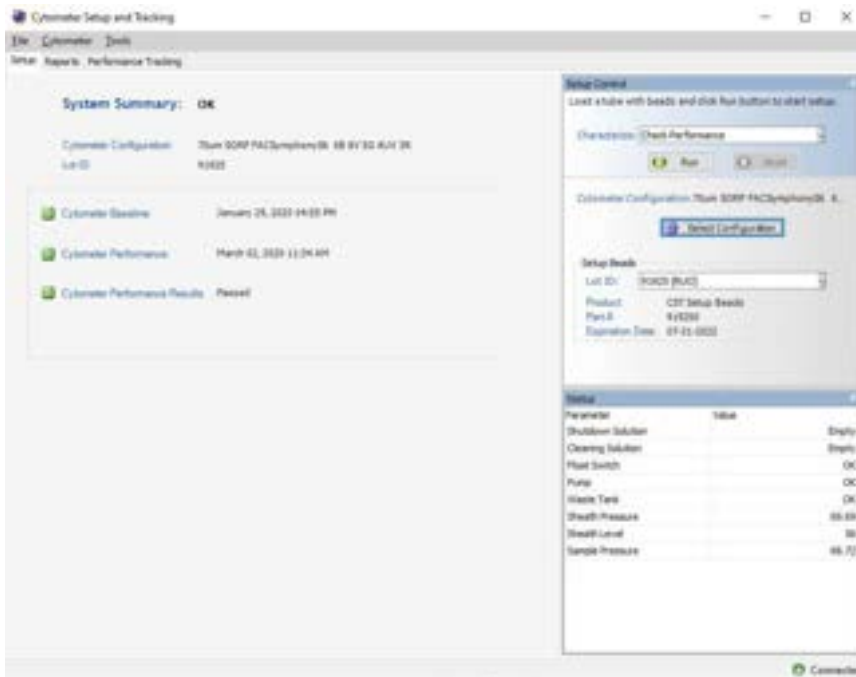

2. Verify that the bead lot information under **Setup Beads** matches the BD® CS&T Research Beads lot.

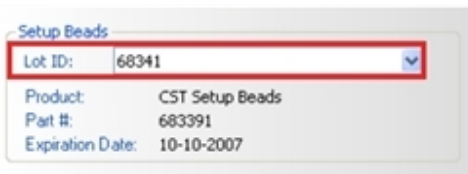

Select the correct lot ID from the menu. The bead lot ID number is located on the BD® CS&T Research Beads vial.

3. Verify that the cytometer configuration is correct for your experiment.

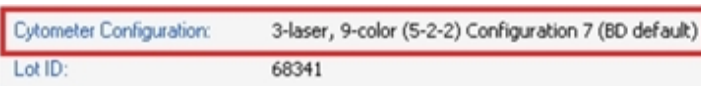

If the cytometer is not set to the correct configuration:

- a. Click **Select Configuration** in the **Setup Control** window.



- b. Select the correct configuration from the list.

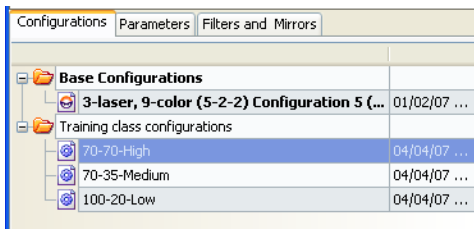

- c. Click **Set Configuration**. Click **OK**.
4. Verify that the current configuration has a valid baseline defined.
If not, see the *BD[®] Cytometer Setup and Tracking Application Guide* for more information on running a baseline.

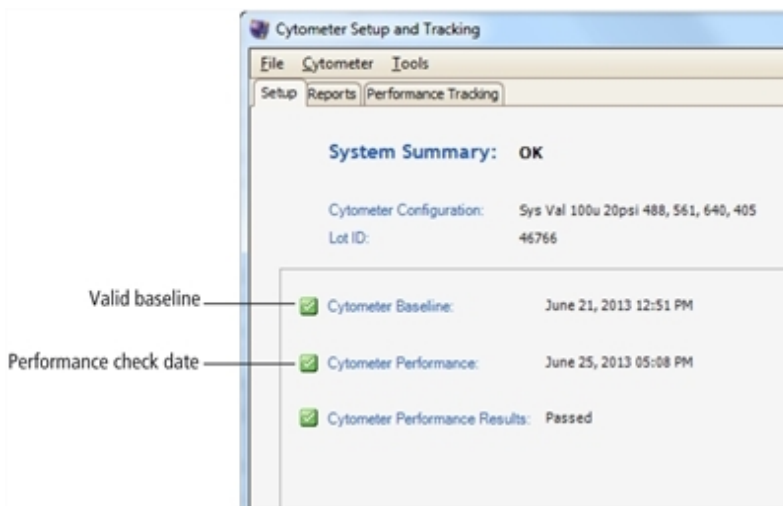

Preparing the BD FACSDiva™ BD[®] CS&T Research Beads

BD FACSDiva™ CS&T Research Beads consist of bright, mid, and dim beads dyed with a mixture of fluorochromes. Use the beads to define a baseline and to check cytometer performance using the CS&T application.

See the BD FACSDiva™ BD® CS&T Research Beads technical data sheet for instructions about preparing the bead suspension. Instructions vary based on the task you are performing.

Running a performance check

The performance check function of BD® CS&T Research Beads will check the cytometer's daily performance.

1. Confirm the lasers are in the Ready state using the laser control software.
2.  Movement of mechanical parts within the instrument can pinch or injure your hands or fingers. Keep your hands and clothing away from the loading port when a tube is loading or unloading. Do not place objects underneath the loading port.
3. In the **Setup Control** window, select **Check Performance** from the **Characterize** menu.
4. Click **Run**.

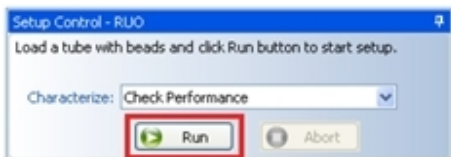

Plots are displayed under the Setup tab and the performance check is run. The performance check takes approximately 5 minutes to complete.

Reviewing the results

1. Once the performance check is complete, click **View Report**.
2. Print the report.
3. Verify that the performance check passed.

In the Setup tab, the Cytometer Performance Results should have a green checkmark and the word *Passed* next to it.

If any parameters did not pass, see the *BD® Cytometer Setup and Tracking Application Guide* for troubleshooting information.

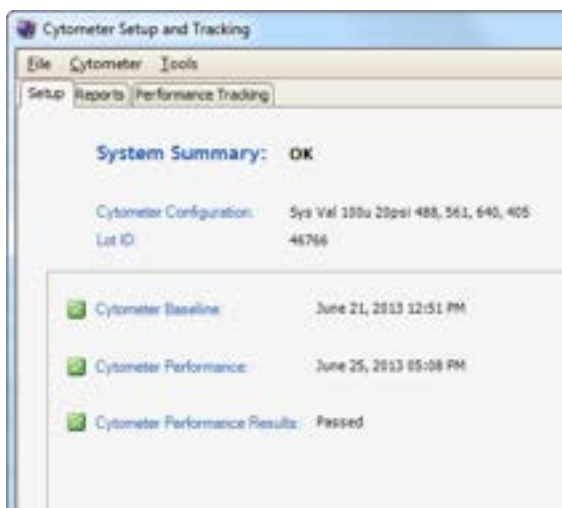

4. Select **File > Exit** to close the BD® CS&T Research Beads window and connect back to the BD FACSDiva™ interface.

5. Click **Use CST Settings** in the **CST Mismatch** dialog that opens.

See [CST Mismatch dialog \(page 103\)](#) for more information.

When CS&T settings are applied to new experiments, the settings applied include PMT voltages, threshold, laser delays, and area scaling factors. (The window extension values are generated from the cytometer configuration.)

When CS&T settings are applied to existing experiments, the settings applied include PMT voltages, laser delays, area scaling factors, and window extensions. Threshold values remain the same.

There is a system preference to always use current BD[®] CS&T Research Beads settings that can be set by the administrator. For BD FACSymphony™ S6 cell sorter users, we recommend that you do not enable this preference.

At this point you can do one of the following:

- Create application settings for an experiment you will use frequently. See [Application settings \(page 103\)](#).
- Collect data using existing application settings. See [Data collection \(page 108\)](#).

CST Mismatch dialog

If there is a mismatch between the BD[®] CS&T Research Beads settings and those in BD FACSDiva™ software, a dialog opens to indicate what the differences are, and gives you the following options:

- **Use CST Settings.** Select this option if you want to use the settings generated from the most recent performance check.
- **Keep BD FACSDiva Settings.** Select this option if you want to keep the settings that are associated with your cytometer.
- **Details.** Click this button to view the differences between the two settings to help with your selection.

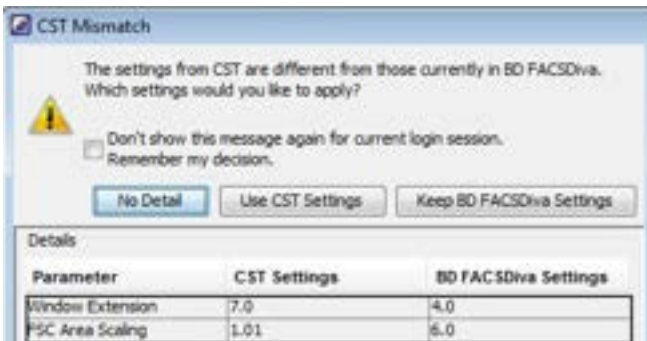

- See [Data collection \(page 108\)](#).

Application settings

Application settings are associated with a cytometer configuration and include the parameters needed for the application, area scaling values, PMT voltages, and threshold values, but not compensation. Each time a performance check is run for a configuration, the application settings associated with that configuration are updated in the catalog. To update the application settings in an existing experiment, right-click the application settings in the Browser and select **Application Settings > Apply**.

Using application settings provides an easy, consistent, and reproducible way to reuse cytometer settings for your commonly used applications. See the *BD[®] Cytometer Setup and Tracking Application Guide* for information on running a baseline and for other details on using the CS&T application.

Before creating application settings you must:

- Perform the cytometer startup procedure described in [Cytometer startup \(page 88\)](#).
- Run a performance check for the cytometer configuration that will be used for the application.

Creating application settings

This section describes how to create and save application settings for a multi-color immunophenotyping sample.

Setting up the workspace

1. Select **Cytometer > View Configurations**, and verify that the current configuration is appropriate for the type of sample you are running.
2. Verify that there is a valid performance check for the configuration.
3. Create a new folder.
4. Create a new experiment.
5. Select the **Cytometer Settings** in the Browser.
6. In the **Inspector** window, click the **Parameters** tab and delete any unneeded parameters.
7. Select the **H** check box to select height for each parameter.

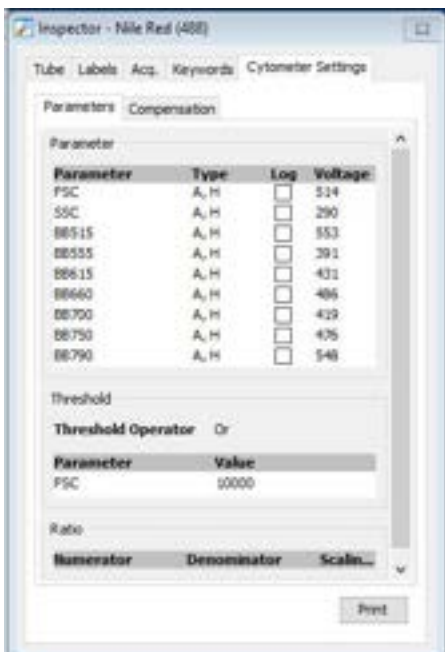

Adjusting area scaling

The required area scaling factor changes based on sheath pressure and particle size. The area scaling factors should be verified for each experiment performed on the cytometer.

Note: You will need to modify the template to support the lasers installed on your system. Don't forget to save the settings when you are done.

1. In the **Browser**, right-click **Global Sheet1** and select **Apply Analysis Template**.
2. In the **Template** dialog, select the **Area Scaling** worksheet and click **OK**.
3. Create a new specimen by clicking the **New Specimen** button on the **Browser** toolbar.
4. Expand the new specimen, then click to set the current tube pointer to Tube_001.

5. Install the FITC-positive control tube onto the loading port and click **Load** on the **Acquisition Dashboard**.



Movement of mechanical parts within the instrument can pinch or injure your hands or fingers. Keep your hands and clothing away from the loading port when a tube is loading or unloading. Do not place objects underneath the loading port.

6. Adjust the FSC and SSC voltages to place the particles on scale.



7. Adjust the P1 gate around the population of interest in the FSC vs SSC plot.

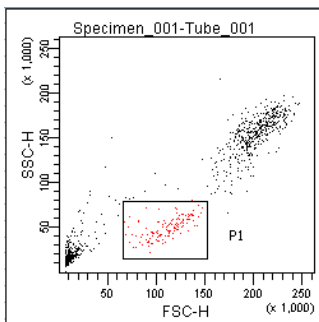

8. Adjust the FSC area scaling.

- a. Click the **Laser** tab in the **Cytometer** window.

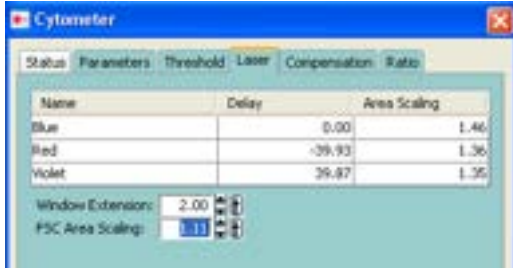

- b. Adjust the FSC area scaling factor until the FSC-A signal matches the FSC-H signal.
- Increase the area scaling factor if the FSC-A signal is lower than FSC-H.
 - Decrease the area scaling factor if the FSC-A signal is higher than FSC-H.
- c. View the result of your change in the histograms and statistics views.

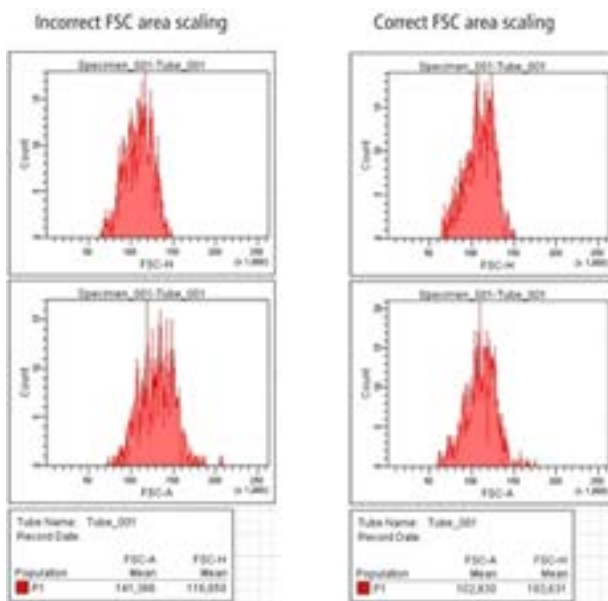

- Adjust the blue laser area scaling until the FITC-A signal matches the FITC-H signal, if needed.
- Unload the FITC-positive control tube, then load the APC-positive control tube.
- Adjust the red laser area scaling until the APC-A signal matches the APC-H signal, if needed.
- Check and adjust, as necessary, the area scaling for the remaining lasers using a single color stained tube. Only one parameter from each laser needs to be used for area scaling.
- In the **Inspector** window, clear the checkboxes for height for all parameters.

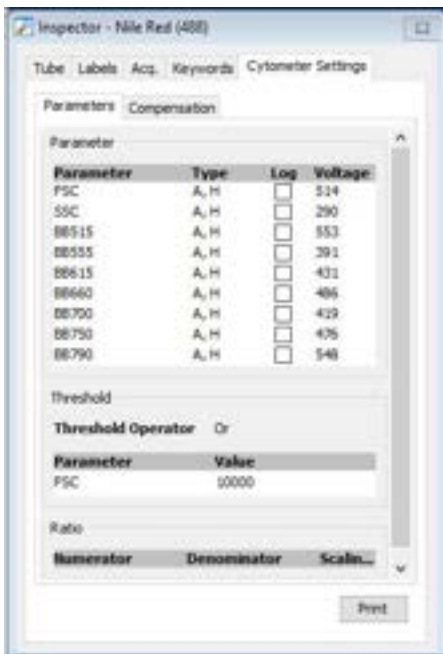

Optimizing PMT voltages

1. Right-click **Cytometer Settings** in the **Browser**, then select **Application Settings > Create Worksheet**.

A second global sheet is added with the plots created according to your selections in the Parameters tab. Use the gray boxes and crosshairs to guide your optimization.

Note: The gray boxes and crosshairs are not displayed until acquisition starts.

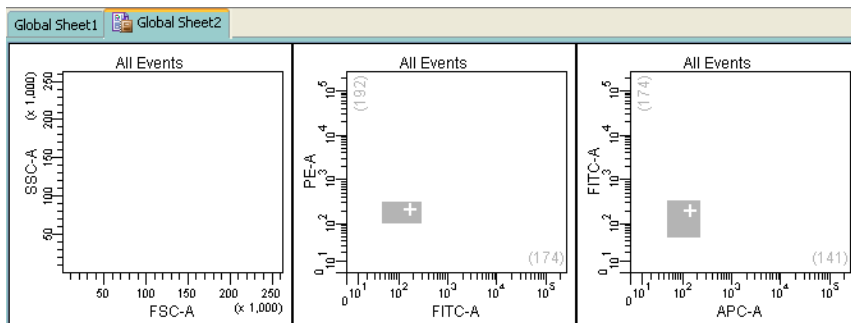

2. Load a multicolor sample tube onto the cytometer.
3. In the **Cytometer** window, optimize the settings for your application.
 - a. Optimize the FSC and SSC voltages to place the population of interest on scale.
 - b. Optimize the FSC threshold value to eliminate debris without interfering with the population of interest.
4. Verify that the positive populations are on scale.

If a positive population is off scale, lower the PMT voltage for that parameter until the positive population can be seen entirely on scale.
5. Unload the multicolor sample from the cytometer.

Saving application settings

1. Right-click **Cytometer Settings** in the **Browser**, then select **Application Settings > Save**, to save the values for reuse.

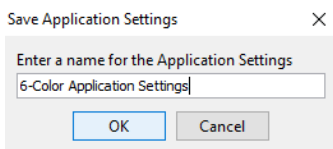

- a. In the **Application Settings** dialog, rename the application settings with a descriptive name.
- b. Click **OK**.

The application settings are saved to the catalog.

Data collection

Before you record data for a sample, cytometer settings should be optimized to position the cells of interest on scale for scatter and fluorescence parameters. In the previous section, application settings were created by taking into consideration the following:

- FSC and fluorescence area scaling
- FSC and SSC voltages
- FSC threshold
- Fluorescence PMT voltages

In this section, the application settings will be applied and compensation will be calculated before collecting test data.

The following sections describe how to use previously optimized application settings for a 4-color experiment. See [Application settings \(page 103\)](#) for more information.

Compensation will be automatically calculated using the compensation setup feature. For more information about this function, see the *BD FACSDiva™ Software Reference Manual*. If you are performing compensation manually, not all steps will apply.

Setting up the workspace





Before you begin optimizing settings, it is important to verify the cytometer configuration and create an experiment containing appropriate parameters for the assay.

1. Select **Cytometer > View Configurations**, and verify that the current configuration is appropriate for the type of sample you are running.
2. Verify that there is a valid performance check for the configuration.
3. Make sure that the HPC(s) contain appropriate filters.

For assistance, see [Cytometer configuration \(page 59\)](#).



For accurate data results, the cytometer optics must match the current cytometer configuration.

4. Click the corresponding buttons on the Workspace toolbar to display the Browser () , Cytometer () , Inspector () , Worksheet () , and Acquisition Dashboard () windows, as needed.
5. (Optional) Create a folder for your experiment.

Select the icon for your database and press Ctrl+N. Rename the folder appropriately. See the *BD FACSDiva™ Software Reference Manual* for ideas on how to organize experiments.

Note: To place an experiment inside a folder, select the folder *before* you create the experiment.

6. Create a new experiment.
7. Rename the experiment appropriately (for example, *4-Color experiment*).
8. Create the following plots for doublet discrimination in the global worksheet:
 - a. FSC-A vs SSC-A, containing a scatter gate
 - b. FSC-A vs FSC-H, displaying events from the scatter gate, with an FSC gate drawn on the plot
 - c. SSC-A vs SSC-H, displaying events from the FSC gate, with an SSC gate drawn on the plot

We recommend that you perform doublet discrimination in order to analyze and sort only singlet events. A procedure is given in [Recording data \(page 113\)](#).

9. Right-click the experiment level **Cytometer Settings** in the Browser and select **Apply Application Settings**.



See [Application settings \(page 103\)](#) for instructions on creating application settings.

10. Select the application setting for your sample and click **Apply**.

The following figure shows a typical error message if there are any mismatches between the application and cytometer settings.

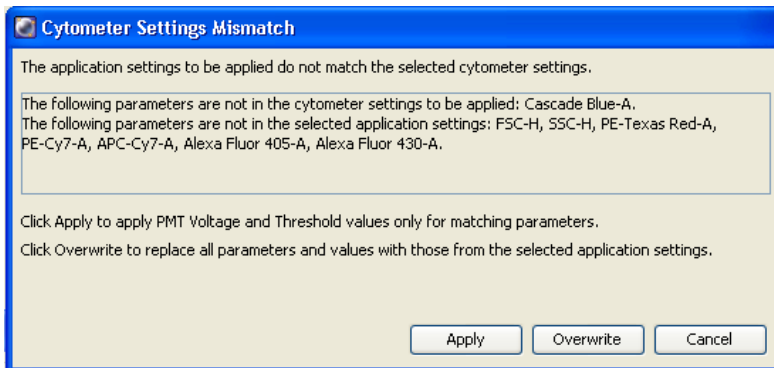

11. Select **Experiment > Compensation Setup > Create Compensation Controls**.

The Create Compensation Controls dialog opens, listing only those parameters associated with the application settings.

12. Click **OK** to add the specified controls.

Alternatively, add and define label-specific controls, then click **OK**.

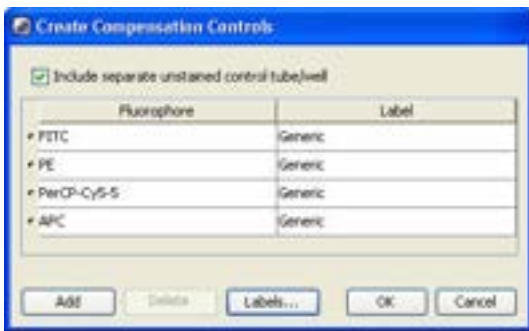

Add label-specific controls when your experiment contains samples stained with the same fluorophore conjugated to different antibodies (labels) that require different compensation values. This is especially useful with tandem conjugates due to lot-to-lot variation. See the *BD FACSDiva™ Software Reference Manual* for more information about this function.

A compensation specimen is added to the experiment, along with a stained control tube for each compensation control. (Expand the specimen to view all tubes.) Worksheets containing appropriate plots are added for each compensation tube.

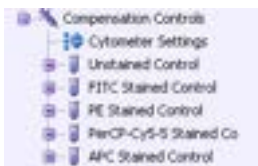

Calculating compensation

The unstained control will be used to verify the settings for FSC, SSC, and FSC threshold, and to gate the population of interest.

1. Confirm the lasers are in the Ready state using the laser control software.
2. Install the unstained control tube onto the cytometer.
3. Expand the compensation specimen in the **Browser**.
4. Set the current tube pointer to the unstained control tube and click **Load**.



Movement of mechanical parts within the instrument can pinch or injure your hands or fingers. Keep your hands and clothing away from the loading port when a tube is loading or unloading. Do not place objects underneath the loading port.

5. Verify that the population of interest is displayed appropriately on the FSC vs SSC plot. Adjust if needed. Since the application settings have already been optimized for your sample, the cytometer settings should require little or no adjustment (unless you are using BD® CompBead particles).

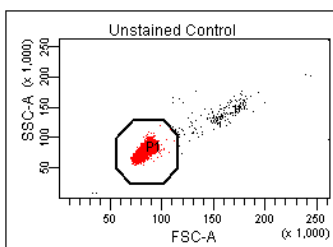

6. Click the **Threshold** tab and adjust the FSC threshold, if needed. Set the threshold to remove most of the debris without cutting off the singlet population.

7. Adjust the P1 gate to surround only the singlets.
8. Right-click the P1 gate and select **Apply to All Compensation Controls**.
The P1 gate on each stained control worksheet is updated with your changes.
9. Click **Record Data**.
10. When recording is finished, click **Unload** and remove the unstained control tube from the cytometer.



Do not change the PMT voltages after the first compensation control has been recorded. In order to calculate compensation, all controls must be recorded with the same PMT voltage settings. If you need to adjust the PMT voltage for a subsequent compensation control, you will need to record all compensation controls again.

11. Install the next tube onto the cytometer and repeat steps 9 and 10 until data for all stained control tubes has been recorded.
12. Double-click the first stained control tube to display the corresponding worksheet.
13. Verify that the snap-to interval gate encompasses the positive population. Adjust the gate, if needed.

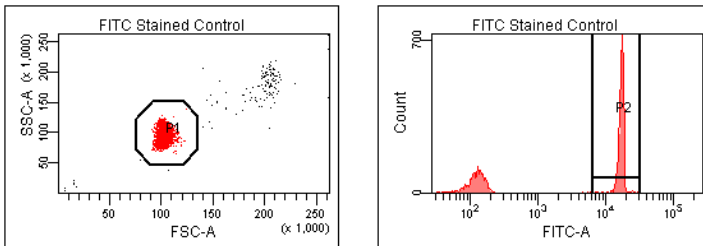

14. Repeat steps 12 and 13 for the remaining compensation tubes.
15. Select **Experiment > Compensation Setup > Calculate Compensation**.
16. Enter the name of your experiment as the setup name, then click **Link & Save**.

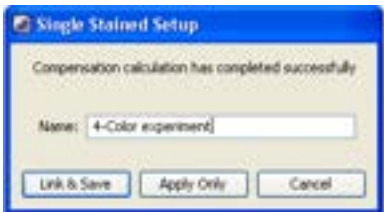

To keep track of compensation setups, include the experiment name, date, or both in the setup name.

Note: We recommend that you always visually and statistically inspect automatically calculated overlap values. The means of the positive controls should be aligned with the means of the negative.

Data recording and analysis

Once you have optimized the cytometer electronics for your sample type, you are ready to record and analyze data.

Before you record data, we recommend that you gate out doublets in order to record only singlet events.

During analysis, recorded data is displayed in plots, and gates are used to define populations of interest. BD FACSDiva™ software analyzes the gated data and calculates statistics that you can print or export. With global worksheets, data can be shown for a series of tubes on the same worksheet, manually or in an automated batch analysis.

The following sections describe how to use BD FACSDiva™ software features to record and analyze sample data.

Setting up the experiment

Before you record data, set up an experiment with appropriate tubes, plots, and labels for your assay. This section describes how to add Browser and worksheet elements to the experiment that was started in the previous section, [Data collection \(page 108\)](#).

1. Rename **Specimen_001** to a descriptive name.
2. Rename **Tube_001** to *4-color_001*.
3. Set the current tube pointer to the **4-color_001** tube.
4. Click **Next Tube** in the **Acquisition Dashboard** to duplicate the first tube with the name *4-color_002*.
5. Use the experiment layout to specify the number of events to record for each tube.

The experiment layout can be used to define the events to record as well as parameter labels for all tubes in an experiment. Labels are displayed on the plot axes and in all statistics views.

- a. Select **Experiment > Experiment Layout**.
- b. In the **Acquisition** tab, select the events to record field for all specimen tubes, and select or enter *5,000* events.
- c. Click **OK**.

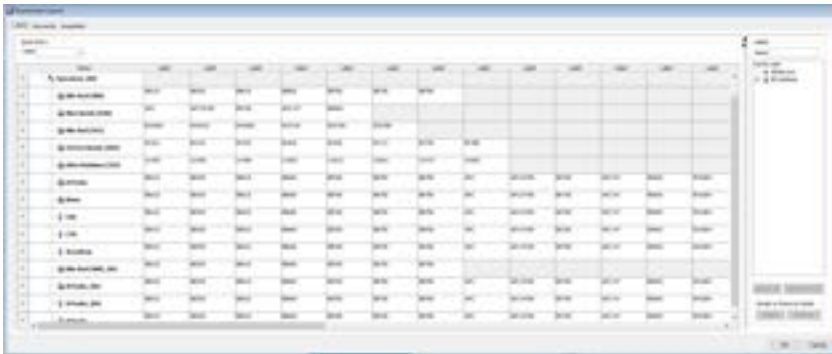

Setting up the global worksheet

A global worksheet is used to perform doublet discrimination and to set up plots to preview and record data.

1. Click the **Worksheets View** button on the **Worksheet** toolbar.

The global worksheet is shown.

The second and third plots are set up to display gated data from the first and second plots, respectively, as shown in the population hierarchy.

2. Create two dot plots for previewing and recording data.

For this example, create a FITC vs PE plot and an APC vs PerCP-Cy5.5 plot.

Note: Double-click the **Plot** button to keep it selected until you create all plots. Click any other button to undo the selection.

3. Turn on biexponential display.
 - a. Select the two plots.
 - b. In the **Inspector**, select the checkbox for **X Axis** and **Y Axis** under **Biexponential Display**.

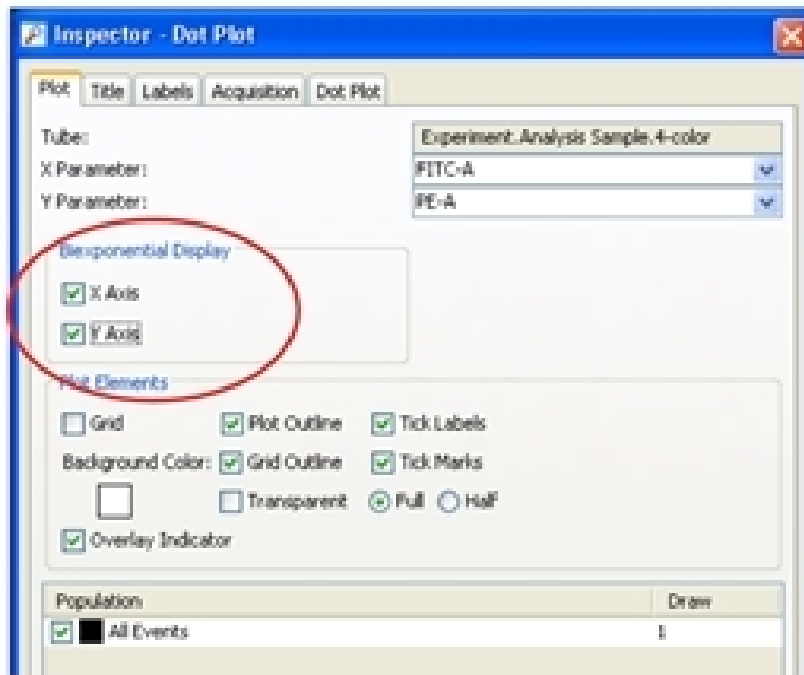

4. Set up the fluorescence plots to display data from the SSC gate.

The SSC gate defines singlet events. By gating the fluorescence plots through this population, only singlet events will be used for analysis and sorting.

 - a. Select the two plots.
 - b. In the **Inspector**, select the **SSC Gate** checkbox.
5. Arrange the fluorescence plots so they fill the page vertically.

Recording data

This section describes how to adjust the gates to eliminate doublets and record singlet events.

1. Confirm the lasers are in the Ready state using the laser control software.
2. Move the current tube pointer to the **4-color_001** tube.
3. Install the first mixed sample tube onto the loading port and click **Load**.



Movement of mechanical parts within the instrument can pinch or injure your hands or fingers. Keep your hands and clothing away from the loading port when a tube is loading or unloading. Do not place objects underneath the loading port.

4. Change the **Events to Display** to 5,000 events.
5. Adjust the scatter gate to encompass the events of interest.
6. Adjust the FSC gate to encompass the low FSC-H population.
7. Adjust the SSC gate to encompass the low SSC-H population.
8. Click **Record** in the **Acquisition Dashboard** to record data.
9. When all events have been recorded, click **Unload** and remove the tube from the cytometer.
10. Install the next tube, then click **Next Tube** in the **Acquisition Dashboard** to move the current tube pointer to the next tube.
11. Repeat steps 7 through 9 for the remaining tubes.

Analyzing data

This section describes how to set up plots, gates, and a statistics view to analyze the recorded data.

1. Select **Edit > User Preferences**.
2. In the **Gates** tab, set the preferences as follows.



3. Create the following gates:
 - Quadrant gate on the FITC vs PE plot.
 - Interval gate on the APC vs PerCP-Cy5.5 plot to capture the APC beads.
 - Rectangle gate on the APC vs PerCP-Cy5.5 plot to capture the PerCP-Cy5.5 beads.
4. Rename each population in the population hierarchy.

Note: Press the Enter key twice to move to the next population without using the mouse.
5. Right-click either fluorescence plot and select **Create Statistics View**.
A statistics view is added to the worksheet.
6. Right-click the statistics view and select **Edit Statistics View**.
7. Edit the statistics view as follows:
 - In the **Header** tab, select the **Use 2 columns for display** checkbox.
 - In the **Populations** tab, clear the checkboxes for all populations except FITC, PE, PerCP-Cy5.5, and APC.
 - In the **Statistics** tab, select the **Mean** checkboxes for the fluorescence-A parameters.
8. Resize the statistics view so it fits on the page.
9. (Optional) Print the analysis.

Performing a batch analysis

Batch analysis allows you to automatically advance through a selected set of tube data when using a global worksheet.

To perform a batch analysis:

1. Verify that the global worksheet you will be using for analysis is displayed in the worksheet window.
2. Right-click the specimen to analyze in the **Browser** and select **Batch Analysis**.

The Batch Analysis dialog opens.

Only tubes under the selected specimen will be processed. Tubes without data are skipped during a batch analysis.

3. Do the following in the **Batch Analysis** dialog.

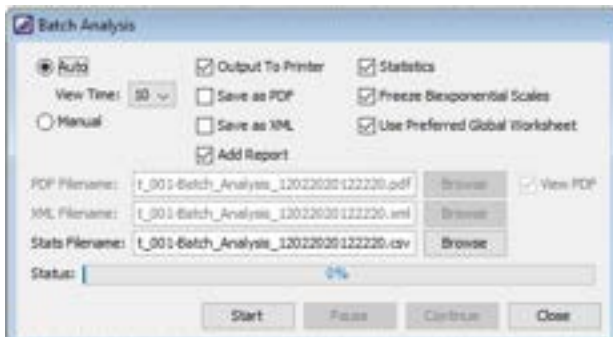

- Select **Auto** to analyze all the files without user intervention.
- Select **5** from the **View Time** menu to pause the analysis for 5 seconds after each tube is loaded.
- Select the **Output to Printer** checkbox to print a copy of the analysis after the data for each tube is loaded.
- Select the **Statistics** checkbox to export the statistics to a separate file, then enter a name for the statistics file. By default, the file is saved at D:\BDExport\Statistics.
- Select the **Freeze Biexponential Scales** checkbox to process all files with the same biexponential scales.
- Clear the **Use Preferred Global Worksheet** checkbox to display analyses of tubes within the same global worksheets. This option is useful for analyzing panels that require a separate global worksheet for each tube.

See the BD FACSDiva™ Software Reference Manual for more information on batch analysis.

4. Click **Start** to begin the analysis.

When the analysis is finished, a completion dialog opens.

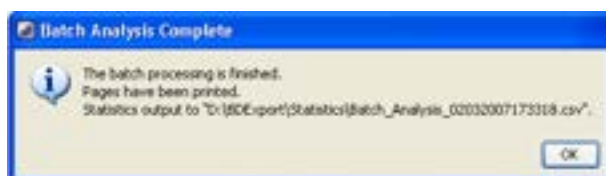

Manual adjustment of laser delay

Laser delay is automatically adjusted during performance checks. However, you may want to adjust laser delay manually, for example, when changing sheath pressure.

The laser-delay factor in BD FACSDiva™ software is used to realign the signals so they can be measured and displayed on the same time scale. Signals are aligned with respect to the blue laser, so the blue laser will have a 0 delay value. The delay values for other lasers will be negative or positive depending on their order in relation to the blue laser.

To manually adjust the delay:

1. Select your experiment folder in the **Browser** and create a new experiment.
2. Rename the experiment *Laser Delay*.
3. Create a specimen and a tube in the experiment and set the current tube pointer next to the tube.
4. On the global worksheet, create a plot for FSC vs SSC and then histograms for each laser.
5. Create a P1 gate on the FSC vs SSC plot and change the histograms to view P1.
6. Prepare a tube of Spherotech™ Rainbow beads.

BD FACFlow™ Solution	Spherotech Rainbow Particles (3.0–3.4 μm)	Ordering Info
1 mL	2 to 3 drops	Cat. No. 556291

7. Load the tube of Spherotech Rainbow beads and click **Load**.



Movement of mechanical parts within the instrument can pinch or injure your hands or fingers. Keep your hands and clothing away from the loading port when a tube is loading or unloading. Do not place objects underneath the loading port.

8. Place the population on scale in the FSC vs SSC plot.
9. Adjust P1 to encompass the singlet population, if needed.

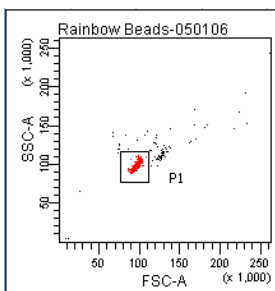

- a. Optimize the delay setting for the red laser.

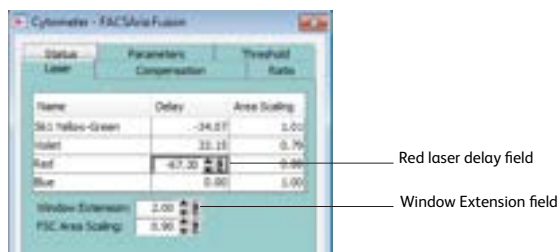

- b. Click the **Laser** tab in the **Cytometer** window.

- c. While watching the peak in the APC-A histogram, change the window extension to 0.
 - If the APC-A signal stayed the same or had little change, then go to step d.
 - If the APC-A signal decreased, then follow steps c through d.
- d. Adjust the laser-delay value until the maximum APC-A signal is achieved.

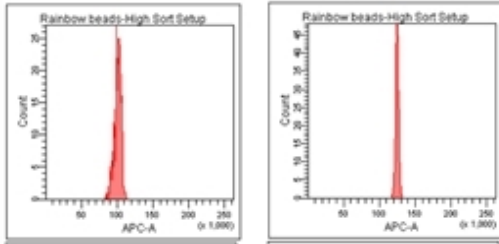

- e. Reset the window extension to the appropriate setting (typically 2).
10. Repeat step 9 for each laser, using the appropriate fluorochrome for each laser.
11. (Optional) To return to the laser delay values determined by CS&T, right-click the cytometer settings in the **Browser** and select **Apply CST Settings**.
12. (Optional) To save this worksheet for future use, export it as an analysis template.
 - a. Right-click the global worksheet in the **Browser**.
 - b. Select **Export > Analysis Template**.
 - c. Name the template *Laser Delay Plots* and click **Save**.

This page intentionally left blank

6

Sorting

You can program BD FACSDiva™ software to sort a specified number of particles from multiple populations into a variety of sorting devices including tubes, plates, and slides. Up to four defined populations can be sorted into each tube, allowing up to 24 populations to be sorted at one time.

The following topics are covered in this chapter:

- [Setting up for sorting \(page 120\)](#)
- [Determining the drop delay – manual method \(page 123\)](#)
- [Determining the drop delay – automatic method \(page 126\)](#)
- [Sorting \(page 127\)](#)
- [Setting up for sorting onto a plate or slide \(page 132\)](#)
- [Index sorting \(page 136\)](#)
- [Terasaki plate adapter \(page 138\)](#)

Setting up for sorting

In general, do the following to set up for a sorting experiment. Each step is explained in more detail in previous or subsequent sections.

1. Start up the cytometer and the computer.
See [Cytometer startup \(page 88\)](#).
2. Install the appropriate size nozzle.
3. Select a new sort setup mode, if needed, and select an appropriate cytometer configuration.
To change your current sort setup mode, select a nozzle size from the **Sort > Sort Setup** menu.
For more information, see [Sort setup \(page 70\)](#).
4. Install a sample line filter, if needed.
See [Installing or removing a sample line filter \(page 159\)](#).
5. Check the laser delay for your sheath pressure and particle size.
 - To set the laser delay automatically using the CS&T module, see [Checking cytometer performance \(page 99\)](#).
 - To set the laser delay manually, see [Manual adjustment of laser delay \(page 116\)](#).
6. If you have the AMO, turn it on at 20%.
See [Operating the BD® Aerosol Management Option \(page 193\)](#).
7. Optimize cytometer settings for the sample to be sorted.
See [Data collection \(page 108\)](#).
8. Install the required collection device and set up the side streams.
See [Setting up for bulk sorting \(page 120\)](#) or [Setting up for sorting onto a plate or slide \(page 132\)](#).
9. Calculate the drop delay.
See [Determining the drop delay – automatic method \(page 126\)](#).
10. Use gating tools and subsetting methods to define the population(s) of interest.
Examples of gating analyses can be found in [Analyzing data \(page 114\)](#).
11. Define a sort layout for the tube containing the defined sort populations and proceed with sorting.
See [Sorting \(page 127\)](#).

Setting up for bulk sorting

This section describes how to set up the streams for two-, four-, or six-way sorting. For sorting using the ACDU option, see [Setting up for sorting onto a plate or slide \(page 132\)](#).



Any cytometer surface that comes in contact with biological specimens can transmit potentially fatal disease. Use universal precautions when handling sorting hardware. Wear suitable protective clothing and gloves.

To set up for bulk sorting:

1. Install collection tubes in the appropriate collection device.
Collection tube holders are available for 1-mL microtubes, 1.5-mL Eppendorf® tubes, 12 × 75-mm tubes, and 15-mL centrifuge tubes. For compatible tubes, see [Labware \(page 190\)](#).

2. Install the collection tube holder onto the cytometer.
 - a. Close the sort block door and open the sort collection chamber door, if needed. The sort block door must be closed to install the tube holder.
 - b. Slide the holder into the slotted fittings below the sort aspirator drawer, then close the sort collection chamber door.



Before installing the collection tube holder, ensure that an O-ring is installed in the groove between the two sections of the tube holder. The O-ring minimizes the chance of aerosols escaping. It can be found in the accessory kit (Catalog No. 337897).

3. Turn on the deflection plates.

Click the **Voltage** button in the **Side Stream** window. The voltage warning light illuminates, indicating that the plates are charged.



A 12,000-volt potential exists between the deflection plates when they are on. Contact with the charged plates results in serious electrical shock. Do not touch the deflection plates when the plate voltage is on. The plates remain energized even when the sort block door is open. Do not set the plate voltage over 6,000V.

Make sure the center stream image does not move after the plates are turned on. Major movement of the center stream could indicate that the plates or the area around the plates needs cleaning.

4. Click the **Test Sort** button and optimize the side streams.

Adjust the voltage sliders to view the required number of streams. If necessary, adjust the plate voltage to achieve deflection in the outermost tubes. Do not exceed a plate voltage of 6000V.

If you cannot see a stream image or the image is dim, adjust the micrometer dial on the diode laser to better view the streams.

5. Adjust the 2nd, 3rd, and 4th Drop settings to tighten the center stream and fine-tune the side streams, if needed.

Generally, the sort setup mode provides good starting values for these settings. Adjust the values only if needed to optimize the streams.

6. Open the aspirator drawer and aim the side stream(s) into each collection tube.

- a. In the **Side Stream** window, click the **Waste Drawer** button to open the drawer.

- b. Open the sort block door and aim each side stream along the horizontal axis into the tube as you adjust the corresponding slider in the **Side Stream** window.

- c. The 6-way sort collection device also includes set screws on either side of the device to center the streams along the front-to-back axis. Adjust the set screws using a 1/16 hex key from the accessory kit.

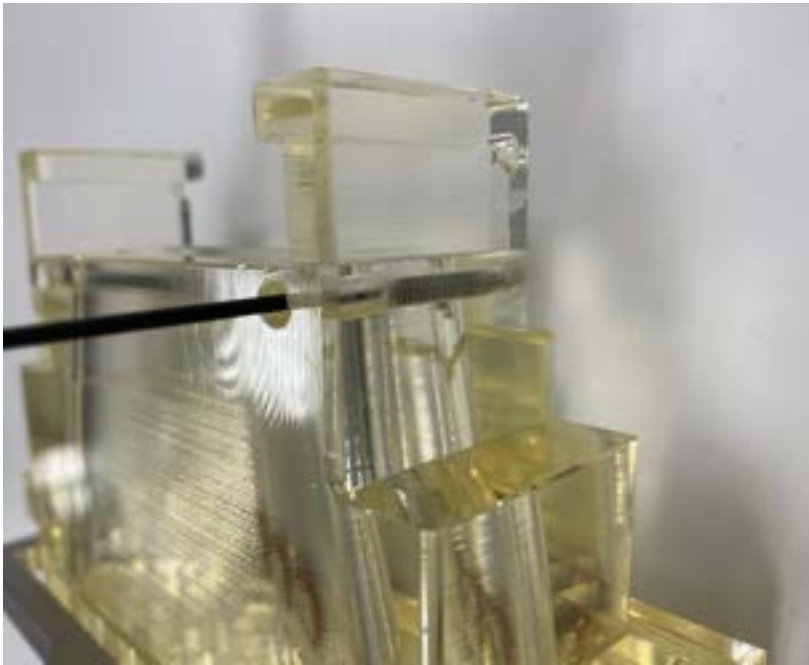

A seal must be formed between the top of the device and the bottom of the sort block. If there is a gap, the front-to-back adjustment is incorrect.

- d. When you are satisfied with the side stream deflection, close the sort block door.
7. Click the **Voltage** button to turn off the deflection plates.
8. Attempt to optimize drop delay using the automatic method first, then if necessary use the manual method. For details, see the following procedures:
 - [Determining the drop delay – automatic method \(page 126\)](#)
 - [Determining the drop delay – manual method \(page 123\)](#)

Using the 1.5-mL side stream alignment tool

If you are using 1.5-mL Eppendorf tubes, use six tubes of ethanol to align the side streams and verify drop placement.

1. Set the optimal breakoff.
2. Ensure that the center stream is aligned with the center of the aspirator drawer.
3. With the aspirator drawer closed (retracted), position the alignment tool in the sort block.
4. Turn on the deflection plates.
5. Click **Test Sort**, then adjust sliders to align each side stream to the corresponding notch on the alignment tool.

Note: To prevent the stream fluid from pooling or splashing, place a wipe or paper towel inside the sample collection chamber.

6. Turn off the deflection plates.
7. Carefully remove the alignment tool.
8. To verify stream alignment, place four capped Eppendorf tubes inside the Eppendorf collection tube holder and insert the tube holder into the sort collection chamber.
9. Turn on the deflection plates.
10. Quickly click **Test Sort** twice to deposit a drop on the Eppendorf tube lids.

- Verify that the drops are deposited on the center of each Eppendorf tube lid.

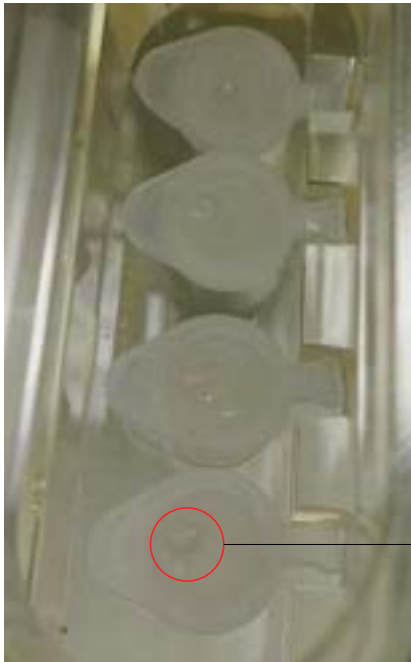

Drop on Eppendorf tube lid

Note: For future reference, record the slider values or take a screen shot of the stream setup window.

Determining the drop delay – manual method

BD FACS™ Accudrop technology is used to determine the optimal drop-delay setting for your sorting application. For more information, see [Drop-Delay Overview \(page 49\)](#).

There are two methods for determining the drop delay.

- **Manual drop delay.** Using the standard method as described in the following sections.
- **Auto drop delay.** Using an automated algorithm method. See [Determining the drop delay – automatic method \(page 126\)](#).

Note: Before beginning these procedures, make sure the stream is stable and the Sweet Spot is on.

Setting up the experiment

This section describes how to set the drop delay using the Accudrop experiment template. Because no data is recorded, the experiment can be reused as often as you like.

- Create an experiment from the Accudrop Drop Delay template.

Select **Experiment > New Experiment**. Select the **Accudrop Drop Delay** experiment and click **OK**.

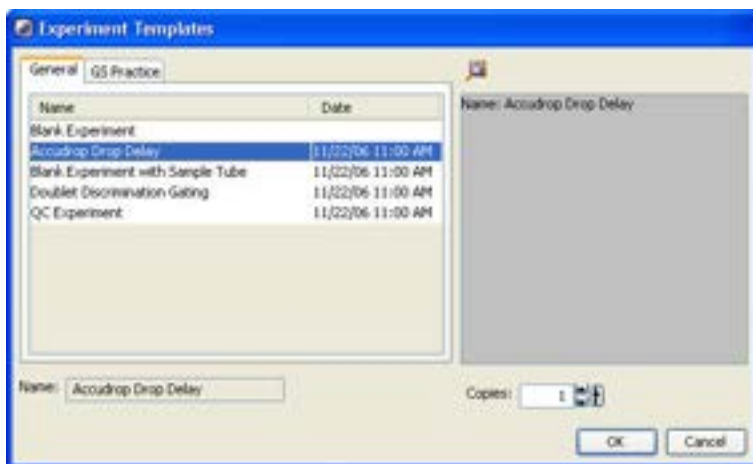

2. Expand **Specimen_001** and **Tube_001**.
3. Set the current tube pointer to **Tube_001**.
4. Open the sort layout by double-clicking it.



Using manual drop delay

This section describes the manual method of optimizing the drop delay.

1. Load a tube filled with a suspension of Accudrop Beads (approximately one to two drops of beads in 0.5 mL of PBS).



Movement of mechanical parts within the instrument can pinch or injure your hands or fingers.

Keep your hands and clothing away from the loading port when a tube is loading or unloading. Do not place objects underneath the loading port.

2. Open the **Parameters** tab of the **Cytometer** window and adjust the FSC and SSC values until events are on-scale. A typical value of FSC is ~500V and of SSC is ~250V.
3. In the **Laser** tab of the **Cytometer** window, set the window extension to zero.

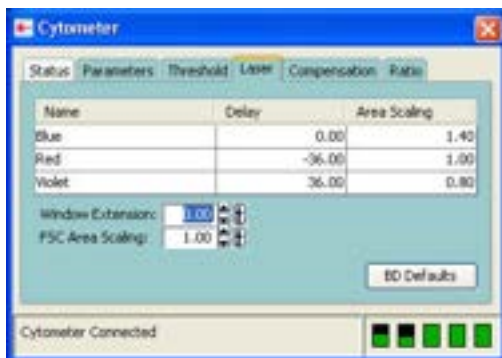

4. Adjust the flow rate to achieve an event rate of 1,000–3,000 events per second.
5. Turn on the voltage in the **Side Stream** window. Click **Sort** in the **Sort Layout** window.

- Click **Cancel** at the **Confirm** dialog.



There is no need to collect the beads. When the drawer is closed, the beads are sorted to waste.

- Adjust the micrometer dial to obtain the brightest bead spot on the center stream.
- Click the **Optical Filter** button in the **Side Stream** window.

This control moves the emission filter that allows you to view the Accudrop Beads in front of the lower camera. When the control is clicked, the image switches from a raw image to a processed (digitized) image. The two boxes indicate the region of the image where the left and center stream intensities are calculated during image processing. The numbers shown are percentages of the total intensity.

If the left side stream is not completely contained in the left region, adjust the voltage slider to place the stream in the center of the region.

- Verify that the sort precision mode is set to **Initial**.
See [Sort Precision Modes \(page 52\)](#) for more information.
- Optimize the drop delay.
Adjust the drop-delay value in 1-drop increments (Ctrl+click arrow control) to achieve close to 100% intensity in the left side stream. Wait a few seconds after each click for a complete response to the delay change.



- In the **Sort Layout** window, change the precision mode to **Fine Tune**.
- Optimize the drop delay.
Adjust the drop-delay value in 0.03-drop increments (click the arrow control) until the left side stream intensity is greater than or equal to 90%. Wait a few seconds after each click for a complete response to the delay change.

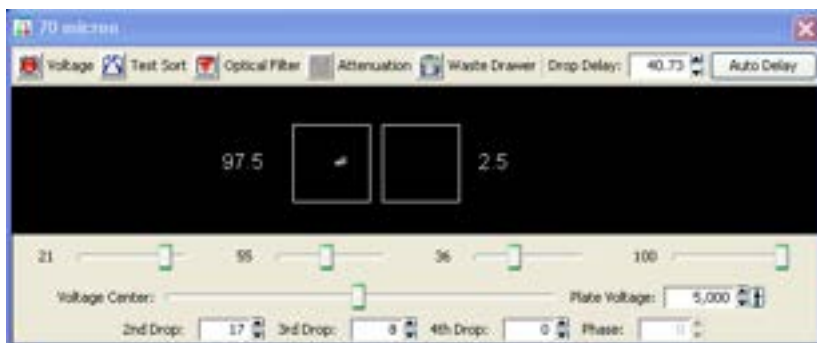

13. Click the **Optical Filter** button to move the emission filter away from the camera.
14. Reset the window extension to its original setting (typically 2).
15. Turn off the deflection plates.

Determining the drop delay – automatic method

The auto drop delay feature automates setting the drop delay to get optimized results from sorting. You should use this method after you have a good understanding of how drop delay works in general. See [Using manual drop delay \(page 124\)](#) for more information.

Overview of auto drop delay

Auto drop delay works best when the sort system is stable, and assumes that Accudrop Beads are used. When the process is started, the auto drop algorithm uses several passes to find best drop delay possible under the current conditions of the system. Coarse passes are used to find the initial drop delay within 2 drops of the ideal. The coarse passes are faster than the fine-tune passes. Fine-tune passes are used to locate the ideal drop delay value considering the current conditions.

Using auto drop delay

1. Set up an experiment for drop delay as described in [Setting up the experiment \(page 123\)](#).
2. Load a tube filled with a suspension of Accudrop Beads (approximately 2 drops of beads in 0.5 mL of PBS).



Movement of mechanical parts within the instrument can pinch or injure your hands or fingers. Keep your hands and clothing away from the loading port when a tube is loading or unloading. Do not place objects underneath the loading port.

3. Adjust the flow rate to achieve these values of events per second:
 - 70 micron = 1,000 to 3,000
 - 85 micron = 800 to 2,000
 - 100 micron = 600 to 1,500
 - 130 micron = 400 to 1,200

Note: If this cannot be achieved using a flow rate setting between 1 and 5, adjust the bead concentration.

4. Turn on the voltage in the **Side Stream** window. Click **Sort** in the **Sort Layout** window.
5. Click **Cancel** in the **Confirm** dialog.

There is no need to collect the beads. When the drawer is closed, the beads are sorted to waste.
6. Adjust the micrometer dial to obtain the brightest bead spot on the center stream.
7. Click the **Auto Delay** button in the **Side Stream** window.

A dialog opens, similar to that shown in the figure that following this procedure. The graph in the left pane of the dialog represents brightness of the stream (Y axis) versus drop delay (X axis). Typically the graph should have a flat portion, with several small peaks in either direction (up or down) or one prominent peak.

Note: If the original drop delay value was close to the appropriate value prior to starting auto delay, then you may not get a graph displayed because few data points were required to determine the optimal drop delay.

8. Select **Start Run** in the **Auto Drop Delay** dialog.
9. Monitor the **Auto Drop Delay** dialog for progress.

A message is displayed when the process is completed.

Note: If the sort is stopped during algorithm execution (either by user action or because the system detected a failure), the run will be stopped with an appropriate message. Start the sort again, verify that the stream is stable and the sort is not pausing, and re-run the auto drop delay.

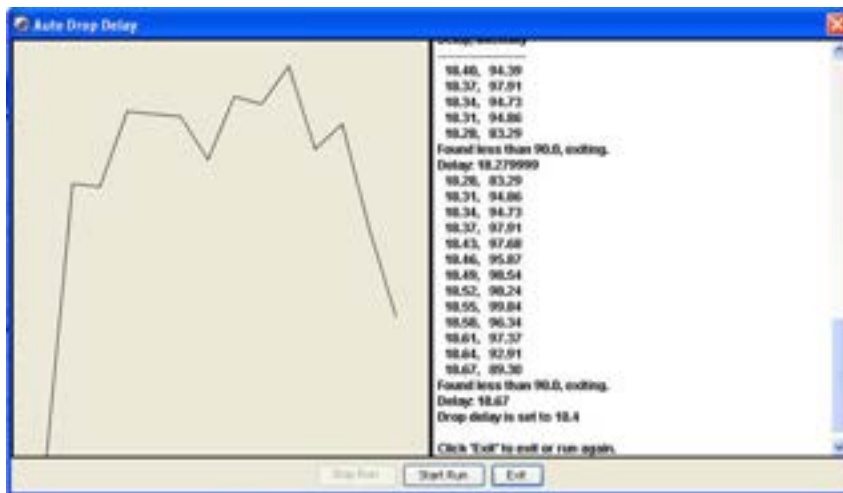

Sorting

Before beginning the sort, do the following:

1. Perform the steps outlined in [Setting up for sorting \(page 120\)](#).
2. Use gating tools and subsetting methods to define the population(s) of interest.

Examples of gating analysis can be found in [Analyzing data \(page 114\)](#).

Note: Gates drawn on a biexponential scale can be used for sorting. However, the cytometer will sort on a log scale. Therefore, a gate that crosses the zero boundaries will sort all events below zero into that gated population. This can cause a variance between the sort results and the statistical results in the software. If the gate is completely below zero on a biexponential plot, no events will be sorted.

Snap-to gates cannot be used for sort gates.

Setting up the experiment

Note: When more than one drop is deflected in the same direction, residual charge from the first drop degrades the quality of the side streams. Thus, when sorting more than one stream to a side or sorting into small wells where precise deflection is required, use the 4-Way Purity mode or select a mode with a yield mask of zero. For more information, see [Yield Mask \(page 50\)](#).

1. Create a new sort layout by clicking the **New Sort Layout** button on the **Browser** toolbar.
By default, the 2-Tube Sort Layout is displayed.
2. Make appropriate entries in the **Sort Layout** window.



- Select the collection device from the **Device** menu.
- Change the sort precision mode to **Purity** (two tubes), **4-Way Purity** (four tubes), or **Single Cell** (plate or slide).
- Enter the number of target events by selecting a value from the menu or entering a number in the field.
- Select a **Save Sort Reports** option: **Save None**, **Save All**, or **Ask User**. See [Setting up a sort layout \(page 73\)](#).
- Select the **Save Conflicts** checkbox if you are using a 2- or 4-tube sort layout and want to save conflicts.
- Select the **Index Sorting** checkbox if you are doing an index sort. See [Index sorting \(page 136\)](#).
- Select the sort location field(s) to be sorted into. Select multiple fields by dragging the mouse. Select a row or column by clicking the row or column header.
- Add the required population(s) to each sort location field.
- To display fewer counters in the **Sort Layout** window, click the **View Counters** button and clear a menu option. The corresponding counter is hidden. (Only counters with a checkmark next to the name are displayed.)

Starting and monitoring the sort

To start the sort:

1. Open the sort collection chamber door and install the collection tubes, plate, or slide.



The flow cell access door is equipped with a shutter mechanism that shuts off the laser light when the door is opened. To ensure there is no interruption to data acquisition, do not open the door while sorting or recording.

2. Close the sort collection chamber door.



Failure to close the sort collection chamber door prevents the evacuator from generating negative pressure in the chamber and could affect drop placement while sorting.

3. Install the sample tube onto the loading port and click **Load**.



Movement of mechanical parts within the instrument can pinch or injure your hands or fingers. Keep your hands and clothing away from the loading port when a tube is loading or unloading. Do not place objects underneath the loading port.

4. Adjust the flow rate.

Sorting results are typically optimized at lower flow rates.

- (Optional) Turn on the deflection plates and open the aspirator drawer.

The deflection plates turn off automatically each time a tube is unloaded. If you do not turn them back on before beginning a sort, a dialog is displayed in which you can turn on the plates and open the aspirator drawer by clicking OK.

- Verify that the current tube pointer is indicating the appropriate tube in the **Browser**, then click **Sort**.
- Click **OK** if you are prompted to open the aspirator drawer or turn on the deflection plates.

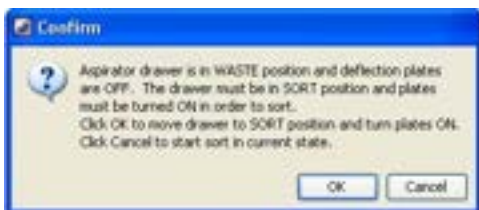

If you click Cancel, sorting will begin with the deflection plates off and the drawer closed. As a result, sort populations will be identified and counted, but no deflection (or sorting) will occur. If you sort with the drawer closed, events will be sorted to waste.

Note: Click **Record Data** to save data for the tube. Acquisition and sorting continue after the required number of events has been recorded.

Sorting continues until the required number of cells has been sorted. Acquisition stops and the drawer closes when sorting is complete. If the number of Target Events is set to Continuous, sorting continues until you manually stop sorting by clicking the Stop Acquiring button in the Dashboard, or the Sort button in the Sort Layout window.

Monitor the sort progress in the Sort Layout window. The number of events sorted into each sort location is displayed in the corresponding field. The sort rate and sort conflict rate are displayed in the corresponding counter fields.



Note: When the Sweet Spot is on, sorting pauses automatically if the Drop 1 or Gap values are out of range. This ensures that sorting occurs only under the proper breakoff conditions. If a more severe problem such as a clog is detected, the stream shuts off and sorting stops. The deflection plates shut off, the aspirator drawer closes, and the sample tube is unloaded.

- (Optional) You can print the sort report at this time, or open the report later and print it then. You can also export the report.

Stopping and Resuming a Sort

The Stop/Resume function allows you to temporarily stop the sort and still retain the counter values. This is particularly useful when the sample volume is low and you need to refill the tube, or to replace collection tubes.

Replacing a sample tube

1. To stop a sort while it is running, click the **Sort** button in the **Sort Layout** window.
2. If prompted, click **OK** to save the sort report.
You can set the sort report to save automatically after each sort. See [Setting up a sort layout \(page 73\)](#).
3. Unload the sample tube by clicking **Unload** on the **Acquisition Dashboard**.
4. Refill the sample tube, then click **Load** in the **Acquisition Dashboard**.



Movement of mechanical parts within the instrument can pinch or injure your hands or fingers. Keep your hands and clothing away from the loading port when a tube is loading or unloading. Do not place objects underneath the loading port.

5. Click the **Resume** button in the **Sort Layout** window to continue sorting.
6. Click **OK** when you are prompted to open the aspirator drawer or turn on the deflection plates.
The sort counters resume from the value where they stopped. The threshold counter restarts. However, the value is accumulated and the total count is saved in the final sort report.

Replacing the collection tubes

1. To stop a sort while it is running, click the **Sort** button in the **Sort Layout** window.
2. If prompted, click **OK** to save the sort report.
You can set the sort report to save automatically after each sort. See [Setting up a sort layout \(page 73\)](#).
3. Click **Stop Acquiring** in the **Acquisition Dashboard** to stop the sample flow.
4. Turn off the deflection plates by clicking the **Voltage** button in the **Side Stream** window.
5. Remove the lower section of collection tube holder by lifting up on the handle and pulling the lower section of the holder down and forward.
6. Replace the collection tubes as needed.
7. Reinstall the tube holder and pull down on the handle to secure it in place.
8. Click **Acquire Data** in the **Acquisition Dashboard** to restart the sample flow.
9. Click the **Resume** button in the **Sort Layout** window to continue sorting.
10. Click **OK** when you are prompted to open the aspirator drawer or turn on the deflection plates.
The sort counters resume from the value where they stopped. The threshold counter restarts. However, the value is accumulated and the total count is saved in the final sort report.

Pausing and resuming a sort

The Pause/Resume function allows you to temporarily pause the sort, and still retain the sort counter values. This is useful when you need to make adjustments to an experiment during a sort. Be aware that the sample continues to flow during a pause.

Note: If you need to replace the sample tube to refill it, or to replace collection tubes, you should stop the sort. See [Stopping and Resuming a Sort \(page 129\)](#).

1. To pause a sort while it is running, click the **Pause** button in the **Sort Layout** window.
2. Make adjustments to the experiment as needed.
3. Click the **Resume** button in the **Sort Layout** window to continue sorting.

Responding to a nozzle clog during a sort

Follow this procedure if your system does not have a BSC or the Aerosol Management Option (AMO).

If your system:

- Does not have a BSC, but does have the AMO, see [Responding to a nozzle clog during a sort with the AMO \(page 195\)](#).
- Does have a BSC and the Aerosol Management System (AMS), see [Responding to a nozzle clog during a sort \(page 211\)](#).

If the stream is disturbed during the sort (due in part to a clogged nozzle), the sort is designed to stop automatically and block the sort tubes (if Sweet Spot is on). If the system detects a clog, it displays the following warning:



The sort will not restart until the operator has cleared the clog. In the event of a nozzle clog, do not open the sort collection chamber door or access the sort tubes before following this procedure.



Cell sorters that use droplet generation methods, such as the BD FACSymphony™ S6 cell sorter, can produce aerosols around the sample stream. When acquiring biohazardous samples, follow universal precautions at all times. Keep the sort block door and the sort collection chamber door closed during sorting. Follow these steps to stop sample flow and evacuate potential aerosols before opening the sort collection chamber door.

To clear a clogged nozzle:

1. If the stream has not already shut down automatically, turn off the stream by clicking the **Stream** button (with a checkmark) at the top of the **Breakoff** window.
This will shut off the stream, unload the sample, and close the aspirator drawer.
2. Turn on the stream and view the breakoff.
If the clog is removed, the breakoff will be similar to the breakoff before the clog.
3. If the clog is not cleared, turn the stream on and off several times to see if the clog will clear itself.
4. If the clog is not removed, turn the stream off and perform the Clean Flow Cell procedure with DI water (see [Cleaning the flow cell \(daily\) \(page 140\)](#)), followed by turning the stream on to see if the clog will be cleared.
5. With the aspirator drawer closed, wait for at least 3 minutes to clear aerosols before opening the sort collection chamber and the sort block door.
6. If it is necessary to change nozzles or remove a clog from a nozzle, see [Cleaning the integrated nozzle \(page 156\)](#).
7. With the stream turned off, open the sort block door and dry the plates and surfaces as needed.



When removing collection tubes, be aware that the outside of the tube is potentially contaminated. Use alcohol swabs or bleach to wipe the outsides of tubes.

8. Make sure that all chamber doors are closed and restart the stream.
9. Perform these tasks if needed:
 - Turn on the Sweet Spot
 - Check the drop delay
 - Check the side stream deflection

Setting up for sorting onto a plate or slide

The following sections describe how to set up for sorting onto a plate or slide. For general guidelines, see [Setting up for sorting \(page 120\)](#).

Installing the sorting hardware



Any cytometer surface that comes in contact with biological specimens can transmit potentially fatal disease. Use universal precautions when handling sorting hardware. Wear suitable protective clothing and gloves.

1. Install the splash shield below the aspirator drawer.
 - a. Close the sort block door and open the sort collection chamber door, if needed.
The sort block door must be closed in order to open the collection chamber door.
 - b. Remove the tube holder, if one is installed.
 - c. Slide the splash shield into the slotted fittings below the sort aspirator drawer and push it all the way in.

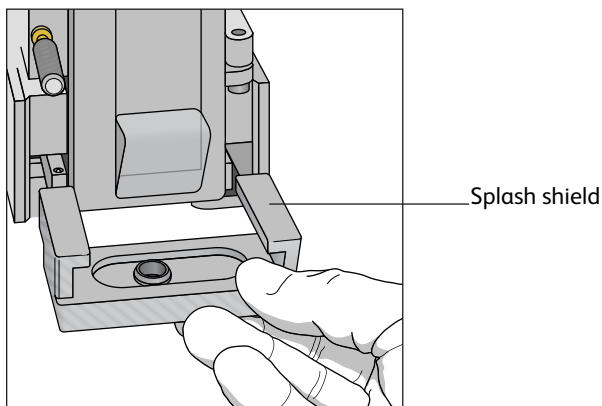

2. Click the **Access Stage** button to bring the ACDU stage to the front.
 - a. Open an experiment, if one is not already open, and create a sort layout for any of the tubes.
 - b. In the **Sort Layout** window, click the **Access Stage** button to move the stage to the front of the sort collection chamber.
3. Install the appropriate collection device on the stage.
 - If you are sorting into a plate, install the plate with well A1 toward the front of the stage.
 - If you are sorting onto a slide, install the slide-adaptor tray with the printed side up. If your slide has a

frosted end, place the frosted end to the right.



Sorting starts on the front left corner of the device (A1 location), and proceeds from front to back, and then from left to right, sorting in a serpentine motion. Thus, for a plate, sorting proceeds from well A1–A12, B12–B1, C1–C12, and so on.

When sorting onto a slide, sorting proceeds in rows across the short end of the slide, and in columns along the long end of the slide. Make sure that you set up your sort layout accordingly.

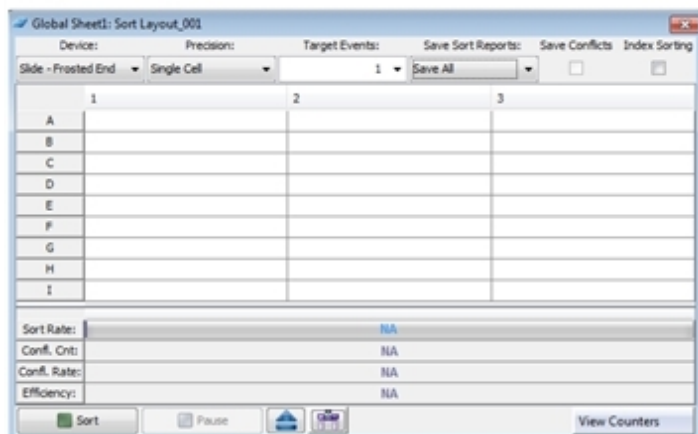
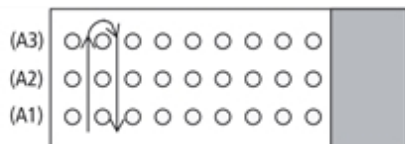

Setting up the stream

This section describes how to optimize side stream deflection and how to adjust the home location.

When sorting onto a plate or slide, the stage is pre-programmed to move a set distance between wells on a plate or spots on a slide. The home location is used as the starting point. The far left stream should hit the center of the well in the top left corner of a plate or the top left corner of a slide at the home location.

Default home location coordinates exist for each standard sort collection device: Falcon® multiwell plates with 6, 24, 48, 96, and 384 wells, and standard or frosted-end slides. For other plate types, you will need to create a custom device. See [Creating a custom device \(page 135\)](#).

Use the following procedure to verify the home location and adjust it.

1. Turn on the deflection plates.

Click the **Voltage** button in the **Side Stream** window. The voltage warning light illuminates, indicating that the plates are charged.

Note: Make sure the center stream image does not move after the plates are turned on. Major movement of the center stream could indicate that the plates or the area around the plates needs cleaning. See [External cleaning \(page 144\)](#).

2. Select **Sort > Home Device**.
3. In the **Device Setup** dialog, select the collection device you are using and click **Go to Home**.

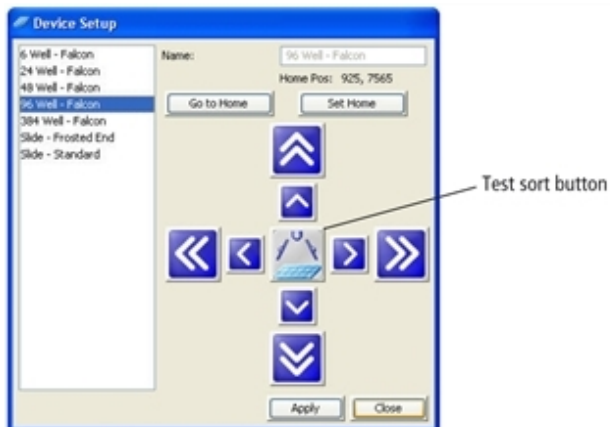

The stage moves to the pre-programmed home position.

4. Click the **Test Sort** button and optimize the far left side stream, then click the **Test Sort** button again to turn it off.

Ensure that the aspirator drawer is open. Adjust the far left slider for minimal deflection of the stream. The stream should be deflected just enough to clear the hole in the splash shield. Do not adjust the other sliders. If you cannot see a stream image or the image is dim, adjust the micrometer dial on the diode laser to better view the streams.

5. Double-click the **Test Sort** button to deposit a drop at the home location.

Note: To ensure consistent drop placement, keep the sort collection door closed when depositing drops on the vessel.

6. Inspect the collection device to see where the drop was deposited.

If you need to move the stage to the front, close the **Device Setup** dialog and click the **Access Stage** button in the **Sort Layout** window.

7. Wipe the collection device dry and place it back on the tray support.

If needed, click the **Access Stage** button to send the stage back and select **Sort > Home Position** to access the **Device Setup** dialog again.

8. Adjust the home location, if necessary.

Click the appropriate arrow buttons to move the tray support as needed. Large arrows move the tray by five steps. Small arrows move the tray by one step.

9. Repeat steps 5 through 8 until the drop is centered appropriately.

10. Click **Set Home**, then **Close**.

11. Click the **Voltage** button to turn off the deflection plates.

12. Optimize the drop delay.

See one of the following procedures:

- [Determining the drop delay – manual method \(page 123\)](#)
- [Determining the drop delay – automatic method \(page 126\)](#)

13. Proceed with [Sorting \(page 127\)](#).

Creating a custom device

You can program the ACDU stage to sort into any grid configuration. Create a custom device by entering the number of rows and columns and setting the home and farthest locations. BD FACSDiva™ software calculates the increment between rows and columns to determine the sort locations. The home and farthest locations for a 96-well plate are A1 and H12, respectively.

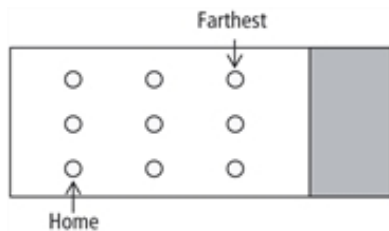

1. Select **Sort > Custom Devices**.
2. Click the **Add** button in the **Custom Devices** dialog.

A new device is added to the list of custom devices. By default, devices are named Custom Device_00x, where x is the next consecutively numbered device.

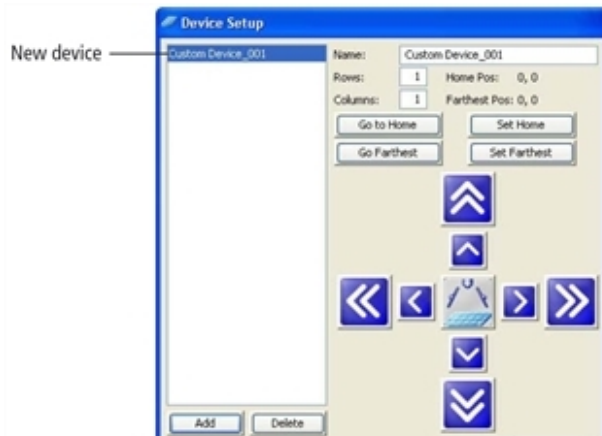

3. Select the text in the **Name** field and enter a new name.
 4. Enter the number of sort location rows and columns.
A device can have up to 60 rows and 25 columns.
 5. Use the arrow buttons and the **Test Sort** button to set the home location, then click **Set Home**.
See [Setting up the stream \(page 133\)](#) for details. There are no default values for custom devices, so greater initial adjustment with the arrow buttons is required.
 6. Use the same procedure to set the farthest location, then click **Set Farthest**.
The farthest sort location is the well or spot on the lower-right corner of the collection device.
 7. Click **Close**.
After you set the home and farthest locations, custom devices are listed in the Device menu in the Sort Layout window.
- Note:** Once custom devices are defined, you cannot change the number of rows and columns.
8. Click the **Voltage** button to turn off the deflection plates.
 9. Proceed with [Determining the drop delay – manual method \(page 123\)](#) and [Sorting \(page 127\)](#).

Deleting a custom device

1. Select **Sort > Custom Devices**.
2. Select the name of the custom device to be deleted in the **Custom Devices** dialog.
3. Click **Delete**.

The device is deleted from the Custom Device list, but is retained within any sort layouts where it was used.

Index sorting

Index sorting allows you to sort single cells onto a plate or slide and indexes the well or slide location to the collected parameters for that cell. You can use this function to ensure that a sorted cell with a specific phenotype has been sorted. Index sorting is useful in characterizing subpopulations of phenotypically similar events using post-sort genetic, chemical, and/or metabolic applications.

Setting up for index sorting

Index sorting uses the same steps as required in setting up for a plate or slide sort. Review the instructions in these sections:

- [Setting up for sorting \(page 120\)](#)
- [Setting up for sorting onto a plate or slide \(page 132\)](#)

To perform an index sort:

1. Create a new experiment, using a global worksheet, for the index sort.
 - Note:** If you want to export data from each well into one CSV file, you must use a global worksheet.
2. Create a new global worksheet.
3. Create the plots and gates needed to define the populations of interest.
4. Create a new sort layout or select an existing sort layout defined for index sorting.
5. Make the following selections in the **Sort Layout** window.
 - Precision = Single cell (recommended setting)
 - Target events = 1
 - Index sorting checkbox = Selected

Make the other selections in the **Sort Layout** window according to your experiment requirements.



6. Click the **Sort** button in the **Sort Layout** window to start the sort.

You must be acquiring sample to start a sort. A new tube is automatically added to the experiment. Upon completion, the new tube will contain the index sort data.

- When the sort is finished, right-click the new tube in the experiment and select **Index Sorting Analysis**. The Index Sorting Analysis displays.

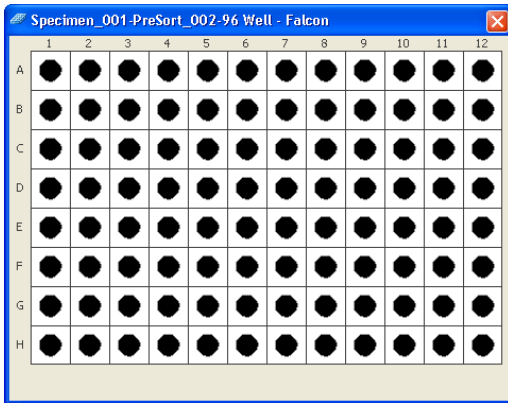

The color legend for the wells is shown in the following table.

Color	Indication
Black	Sorted well data is showing in the plots
Gray	Sorted well data is available, but not showing in the plots
White	No sorted events
Red	More than one event sorted into a well

- Select a well in the Index Sort Analysis to see the event sorted into that well displayed in a plot.



After selecting an individual well, the other wells in the Index Sort Analysis turn to gray, indicating that they contain data, but are not being displayed.

You can select multiple wells by Shift+clicking or Ctrl+clicking. You can also drag over multiple wells in the Index Sort Analysis to display multiple wells.

- To increase the size of a dot on a plot for better visibility, open the population hierarchy, select a population, navigate to the **Population Inspector**, and select a larger size.
- To see the statistics for an index sort, right-click a plot and select **Create Statistics View**.
- To export the statistics for an index sort as a CSV file, right-click in the statistics view and select **Export Index Sort Statistics**.
- In the dialog that opens, navigate to the location where you want to save the CSV file and click **Save**.

Terasaki plate adapter

A Terasaki plate adapter is available as an option to enable the use of 60-well and 72-well Terasaki plates with the ACDU. A Terasaki plate is installed into the adapter, and then the plate/adapter assembly is loaded onto the ACDU.



Terasaki plate adapter showing location of set screws

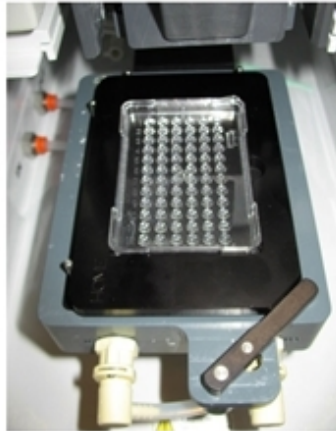

Terasaki plate in adapter installed on ACDU

Using the adapter

The adapter has three set screws that enable the fit to be adjusted for the plates.

1. Install a Terasaki plate into the adapter with the A10 or A12 well at the bottom left corner of the adapter.
2. Tighten the set screws so the plate is held firmly and does not move within the adapter, but do not over-tighten because you need to be able to remove plates easily.

The set screws should not have to be adjusted after the initial fitting process.

Using the correct device in the sort layout

During the sort layout setup process, you have to select the correct device in the Sort Layout window so the ACDU knows the layout and location of the wells on the Terasaki plate.

1. In the **Sort Layout** window, select the **Device** menu.
2. Navigate to the bottom of the list, then select the plate you are using (60-well or 72-well).

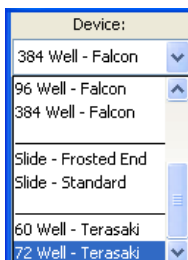

The sort layout displays with the correct number of rows and columns.

7

Shutdown and maintenance

This chapter explains the routine maintenance procedures you should follow to keep your BD FACSymphony™ S6 cell sorter in good condition.

Shutdown and maintenance procedures are presented as follows:

- [Daily shutdown \(page 140\)](#)
- [Scheduled maintenance \(page 144\)](#)
- [Unscheduled maintenance \(page 155\)](#)

Daily shutdown

In the BD FACSymphony™ S6 cell sorter system, the recommended daily shutdown procedure is to run the Clean Flow Cell command with the closed-loop nozzle installed (see the next section). This procedure fills the flow cell with cleaning solution. This is normally sufficient to keep the flow cell clean and operating properly.

If the system is used to process many different sample types, or the system has problems with contamination, you can perform a more extensive cleaning by running the Fluidics Shutdown command. See [Fluidics Shutdown \(Weekly or As Needed\)](#) (page 142).

In addition to one of these procedures, you should also perform an external cleaning. See [External cleaning](#) (page 144).

Cleaning the flow cell (daily)

Use the Clean Flow Cell command to run a tube of 1.5% solution of BD® Detergent Solution Concentrate through the sample line and flow cell.

Note: After the procedure is complete, the detergent solution remains in the flow cell until the stream is restarted. The solution should not be left in the flow cell for long periods. For shutdowns that will last more than a day, perform Fluidics Shutdown as described in [Fluidics Shutdown \(Weekly or As Needed\)](#) (page 142).

To clean the flow cell:

1. Turn off the stream.
2. Mix a 1.5% dilution of BD® Detergent Solution Concentrate (catalog number 660585) as described in the instructions provided with the detergent.



Do not mix BD® Detergent Solution Concentrate with bleach because they produce chlorine gas.

3. As a precautionary measure, prior to opening the Flow Cell access door, use the **Stop** button in the laser control software to put the lasers in standby and then close the laser control software. This will turn off the laser diode, but will keep the diode temperature constant.
4. Remove the nozzle and install the integrated closed-loop nozzle.
If you are using a standard closed-loop nozzle, verify that there is an O-ring in the nozzle before installing it.
5. Select **Cytometer > Cleaning Modes > Clean Flow Cell**.
6. When prompted, install a tube containing the 1.5% BD® Detergent Solution Concentrate, then click **OK**.
The cytometer loads the tube and fills the flow cell with the detergent solution.
7. Click **OK** when the completion dialog opens.
8. Turn off the lasers using the laser buttons on the Laser Power Panel.
9. Turn off the cytometer main power.
10. Turn off the Temperature Control Option if it was used.
11. Exit BD FACSDiva™ software and shut down the computer.
12. Turn off the in-house air or the compressor.
13. Vent the air pressure from the sheath tank by pulling up on the vent ring.
14. If the cell sorter is installed in a BSC, leave the BSC blower on and close the view screen by lowering the sash to the lowest (ready safe mode) position.

Deep cleaning the flow cell (weekly or as needed)

1. Stop the stream.
2. Install the integrated closed loop nozzle.
3. Carefully pull the tubing out of the bubble detector, taking care not to pull it out of the sample pinch valve.

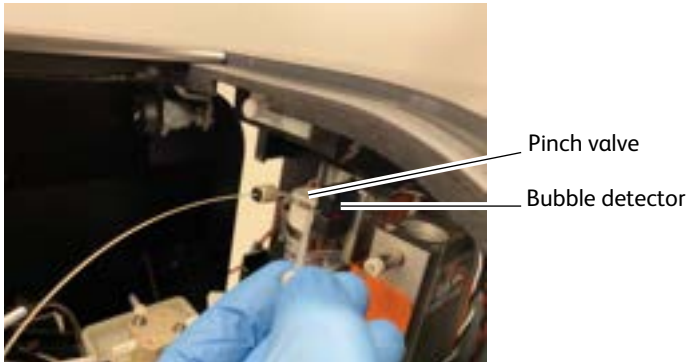

4. Select **Cytometer > Cleaning Modes > Clean Flow Cell**.
5. Mix a 1.5% dilution of BD[®] Detergent Solution Concentrate (catalog number 660585) as described in the instructions provided with the detergent.



Do not mix BD[®] Detergent Solution Concentrate with bleach because they produce chlorine gas.

6. When prompted, install a tube with at least 4ml of 1.5% solution of BD[®] Detergent Solution Concentrate then click **OK**.



Do not mix BD[®] Detergent Solution Concentrate with bleach because they produce chlorine gas.

The cytometer loads the tube and fills the flow cell with the detergent solution.

7. When the completion dialog displays, click **OK**.
8. Select **Cytometer > Cleaning Modes > Clean Flow Cell**.
9. When prompted, install an empty tube, then click **OK**.
The cytometer loads the tube, which will create bubbles that scrub the inside of the sample path and flow cell.
10. Repeat steps 4 to 9 two more times.

- Carefully push the tubing back into the bubble detector. Make sure that the tubing is fully inserted. A cotton swab may be used to push it in.

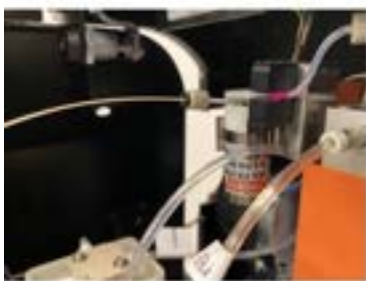

- Select **Cytometer > Cleaning Modes > Clean Flow Cell**.
- When prompted, install an empty tube, then click **OK**.
When the tube loads, the bubble detector should trip and LED should flash. If it does not, check tubing to be sure it is fully inserted and then repeat this procedure from step 12.
- If the system will be shut down for more than 1 day, perform Fluidics Shutdown as described in [Fluidics Shutdown \(Weekly or As Needed\) \(page 142\)](#).

Fluidics Shutdown (Weekly or As Needed)

The Fluidics Shutdown command can be used to perform an extensive cleaning if the system is used to process many different sample types, or the system has problems with contamination. This procedure removes sheath fluid from the lines and fills them with 70% ethanol, and cleans the flow cell.

Preparing for shutdown

- Unload the sample tube, if one is loaded.
- Turn off the stream.
- Check the waste container and empty it if needed.
See [Emptying the waste tank \(page 97\)](#).
- Check the ethanol shutdown tank and refill it if needed.
See [Refilling the ethanol shutdown tank \(page 95\)](#).

Running fluidics shutdown

- Select **Cytometer > Fluidics Shutdown**.
The **Fluidics Shutdown** dialog opens.
- As a precautionary measure, prior to opening the Flow Cell access door, use the **Stop** button in the laser control software to put the lasers in standby and then close the laser control software. This will turn off the laser diode, but will keep the diode temperature constant.
- Remove the nozzle from the flow cell assembly and click **Done**.

4. Insert the integrated closed-loop nozzle into the flow cell assembly and click **Done**.
If you are using a standard closed-loop nozzle, verify that there is an O-ring in the nozzle before installing it.



5. Connect the air and fluid lines to the stainless steel ethanol shutdown tank.
 - a. Disconnect the air line from the sheath tank and connect it to the air port on the ethanol shutdown tank.
 - b. Disconnect the fluid line from the bottom side of the sheath filter and connect it to the ethanol filter on the ethanol shutdown tank.
Remove the sheath filter and replace with the ethanol filter. Do not run ethanol through the sheath filter.
 - c. Click **Done**.

The system starts the cleaning process, and then displays a message at the bottom of the dialog.

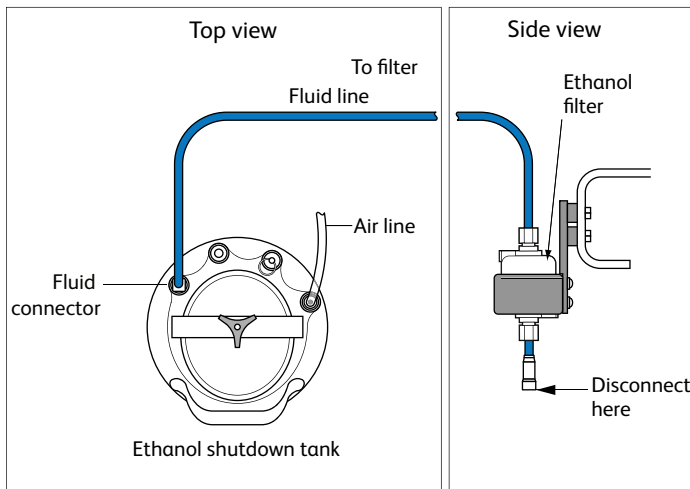

6. When prompted, install a tube containing 3 mL of sterile, filtered DI water on the loading port, then click **Done**.



The cytometer loads the tube and continues the cleaning process. A progress message is displayed, and then Done is displayed when the process is complete.

7. Click **OK** when you see a message informing you that the system can be turned off.
8. Turn off the in-house air or the compressor.
9. Vent the air pressure from the sheath tank by pulling up on the ring on the pressure relief valve.
10. Turn off the lasers by pressing the lighted buttons on the Laser Power Panel.
11. Turn off the cytometer main power.
12. Turn off the Temperature Control Option if it was used.
13. Exit BD FACSDiva™ software and shut down the computer.

14. If the cell sorter is installed in a BSC, leave the BSC blower on and close the view screen by lowering the sash to the lowest (ready safe mode) position.

External cleaning

To keep the system free from salt buildup, wipe down all cytometer surfaces that have been exposed to sheath fluid. Clean surfaces with a cloth dampened with a 10% bleach solution, followed by DI water.



All cytometer surfaces that come in contact with biological specimens can transmit potentially fatal disease. Use universal precautions when cleaning cytometer surfaces. Wear suitable protective clothing, eyewear, and gloves.



To prevent shock, turn off the plate voltage before cleaning on or around the deflection plates. To prevent arcing (sparking), make sure the plates are completely dry before you turn the plate voltage back on.

The following surfaces should be inspected and cleaned when necessary:

- Inside the sort chamber
- Deflection plates
- Sample loading port
- Collection devices

Scheduled maintenance

For optimal cytometer functioning, perform the following procedures according to the recommended maintenance schedule.

Procedure	Recommended Frequency
Internal cleaning (page 144)	See the table in the following section.
Purging the fluid filters (page 148)	Weekly
Purging the sheath filter (page 148)	Weekly
Changing the disposable waste cap (see Emptying the waste tank (page 97))	Monthly
Changing the fluid filters (page 148)	Every 6 months
Changing the sheath/ethanol filter (page 149)	Every 6 months
Changing the sample lines (page 150)	Every 4–6 months, or as needed
Changing the air filter (page 154)	Every 6–12 months, depending on cytometer use and the quality of the air
Changing the Sheath Tank Air Filter (page 154)	Every 6 months

Internal cleaning

BD FACSDiva™ software includes four pre-programmed cleaning modes that can be used alone or in combination to provide the required level of cleaning. The following sections describe the different cleaning

modes.

Cleaning Mode	Summary	Frequency
Sample line backflush (page 145)	Flushes the sample line with sheath fluid.	After running samples with adherent cells or dye.
Cleaning the flow cell (daily) (page 140)	Cleans the sample path and the flow cell with DI water.	When indicated by distorted scatter or high CVs, or as a daily shutdown procedure.
Prime after tank refill (page 145)	Primes the fluid lines for the designated fluid(s).	When a fluidics line is unplugged to refill a tank.
Prepare for aseptic sort (page 146)	Decontaminates the complete sheath path and sample path with bleach, DI water, and ethanol.	When needed before aseptic sorting.

Sample line backflush

After a sample tube is unloaded, the sample line tubing within the sample injection chamber is automatically flushed inside and out with sheath fluid to eliminate potential sample carryover. Use the Sample Line Backflush command to perform additional backflushing of the inside of the sample line after a tube is unloaded. Perform the sample line backflush when you observe sample carryover or after running samples with adherent cells or dye.

Note: Keep the stream running while performing the backflush.

1. Select **Cytometer > Cleaning Modes > Sample Line Backflush**.
2. Click **Start** to start the backflush.
3. Click **Stop** to stop the backflush, or click **Cancel** to stop the backflush and close the dialog.
The backflush does not stop automatically.

Prime after tank refill

Use the Prime After Tank Refill command to prime the fluid lines if a 5-L plastic fluidics container was disconnected for refilling.

1. Turn off the stream.
2. Select **Cytometer > Cleaning Modes > Prime After Tank Refill**.
3. Select the checkboxes for the tanks that were refilled, then click **OK**.
The cytometer proceeds with priming the specified tanks. A progress dialog opens while the tanks are being primed.
4. Click **OK** when the tank prime is complete.

Removing the sheath probe

The sheath probe must be removed from the sheath tank before autoclaving the tank in preparation for performing the aseptic sort procedure.

Note: Do not autoclave the sheath probe. It is not designed to withstand the conditions of autoclaving.

Make sure to perform the following steps in sequence, so the containment device works properly.

1. Disconnect the air line from the sheath tank.
2. Vent the air pressure from the sheath tank by pulling up on the pressure relief valve. Verify that all of the pressure is released by pulling up a second time.
3. Loosen the nut at the top of the probe with a wrench.

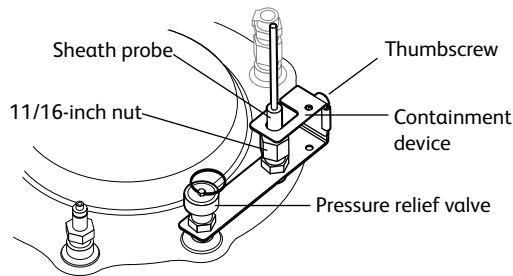

4. Loosen the thumbscrew on the containment device.
5. Pull the top section of the containment device straight up and out of the bottom section.

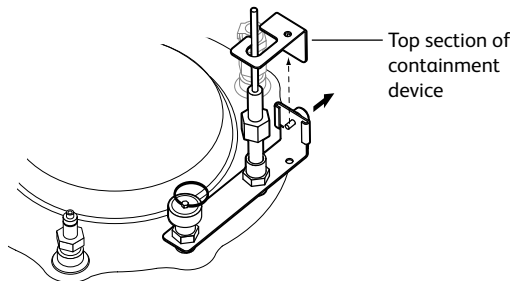

6. Finish loosening the 11/16-inch nut at the top of the probe and pull the probe straight up and out of the sheath tank.
7. Decontaminate the sheath probe using 70% ethanol.

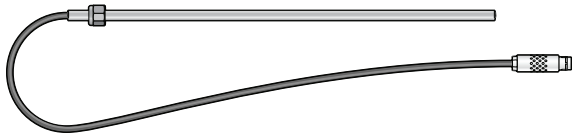

Prepare for aseptic sort

Use the Prepare for Aseptic Sort command when you want to decontaminate the entire sheath path. This procedure cleans the system with bleach, DI water, and ethanol.

Perform the following steps before starting the Prepare for Aseptic Sort command:

1. Verify that the pressure has been vented from the sheath tank and the sheath probe has been removed. See the preceding section.
2. Disconnect the fluid and air lines from the sheath tank.
3. Empty the sheath tank and rinse it with DI water.
4. Autoclave the sheath tank at 125 °C and 15 psig for 30 minutes with a 7.5-minute warmup and shutdown cycle.
5. Fill the sterilized sheath tank with sterile sheath fluid.
6. Obtain a new sheath filter to replace the old filter when instructed to do so in the wizard. See [Changing the sheath/ethanol filter \(page 149\)](#).
7. Install the decontaminated sheath probe into the sheath tank and tighten the nut securely with a wrench.

8. Install the top section of the containment device into the bottom section, and then tighten the thumbscrew.
9. Sterilize the DI water sensor by soaking in a 10% bleach solution for 10 minutes.
10. Fill the DI water container with sterile DI water and 3 mL of bleach per liter of DI water, and then reinstall the sterilized DI water sensor.

To run the Prepare for Aseptic Sort command:

1. Select **Cytometer > Cleaning Modes > Prepare for Aseptic Sort**.

Follow the instructions on screen as you perform the procedure.

2. As a precautionary measure, prior to opening the Flow Cell access door, use the **Stop** button in the laser control software to put the lasers in standby and then close the laser control software. This will turn off the laser diode, but will keep the diode temperature constant.
3. Install the integrated closed-loop nozzle in the flow cell and click **Done**.
If you are using a standard closed-loop nozzle, verify that there is an O-ring in the nozzle before installing it.
4. Remove the fluid line from the DI water port, connect the fluid line from the bleach/BD FACSClean™ container to the DI water port, then click **Done**.

Do not disconnect the sensors from either container.

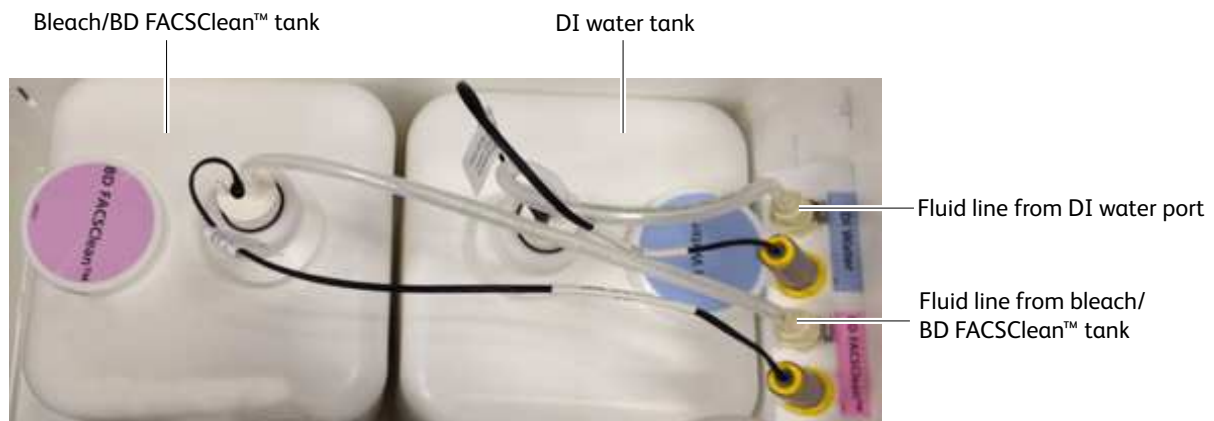

5. Disconnect the bleach/BD FACSClean™ fluid line from the DI water port, and connect it back to the bleach container port, then reconnect the DI fluid line to the DI water port, and click **Done**.
6. Disconnect the sheath fluid line from the sheath filter (at the output side) and connect it to the fluid out port on the connectors panel on the side of the fluidics drawer. Click **Done**.

The system cleaning takes approximately 20 minutes.

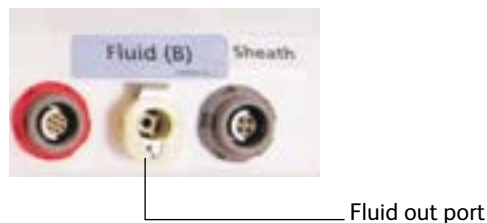

7. Disconnect the fluid line from the fluid out port on the side of the fluidics drawer and connect it to a new 0.2- μ m sheath filter. See [Changing the sheath/ethanol filter \(page 149\)](#).
8. Remove the old sheath filter and connect the new 0.2- μ m sheath filter to the liquid port of the sterilized sheath tank.
9. Reconnect the fluid and air lines to the sheath tank.
10. To complete the process, select one of the two options.

- To continue running samples, perform fluidics startup.
- To turn off the system, perform the flow cell cleaning procedure.

Purging the fluid filters

Once a week, purge air from the fluid filters for the 5-L plastic containers by opening the bleeder valve on the top of each filter. This ensures that the filters will not dry out.

1. Open the bleeder valve a small amount and leave it open until fluid seeps out through the valve.

Note: If the fluid does not seep, close the valve, prime the fluid lines, and try again. It might take a few minutes for the air to purge.

2. Close the valve.
3. Wipe up any excess fluid that might have dripped into the fluidics drawer.

Purging the sheath filter

Once a week, purge air from the sheath filter by opening the bleeder valve on the top of the filter. The sheath tank is pressurized, so do this task carefully to avoid spraying sheath fluid on any equipment.

1. Place a small container under the bleeder valve to catch any fluid.
2. Slowly open the bleeder valve a small amount and leave it open until fluid seeps out through the valve.
3. Close the valve.
4. Wipe up any excess fluid that might have dripped into the fluidics drawer.

Changing the fluid filters

We recommend changing the fluid filters every six months. Spare filters are included with the accessory kit.



1. Remove the filter by pressing the tabs on each quick-disconnect coupling.
2. Install the new filter with the flow arrow point down and connect the quick-disconnect couplings.
3. Write the current date on the new filter so you will know when to replace it.
4. Open the bleeder valve on top of the filter a small amount and leave it open until fluid seeps out through the valve.
5. Close the valve.
6. Wipe up any excess fluid that might have dripped into the fluidics drawer.

Changing the sheath/ethanol filter

Introduction

The sheath/ethanol filter can be used to filter either sheath fluid or ethanol fluid. You need to change the filter depending on the procedure you are doing and the indications in the software.

About this task

Note: Before it is installed, a fluid filter can be used as a sheath filter, or an ethanol filter. After the filter is installed for one of these purposes, however, you cannot use it for a different purpose. Because of this, you should label each filter so that you know which one to use for each purpose.

When you use the filter as a sheath filter, you should change it every six months, or when increased debris in an FSC vs SSC plot indicates that the sheath filter needs to be replaced.

Spare filters are included with the accessory kit.

Procedure

To change the sheath/ethanol filter:

1. Turn off the stream.
2. Disconnect the air line from the sheath tank.
3. Pull up on the ring of the pressure relief valve to release the pressure from the tank. Verify that all of the pressure is released by pulling up a second time.
4. Disconnect the filter by the pressing the metal tabs on each end.

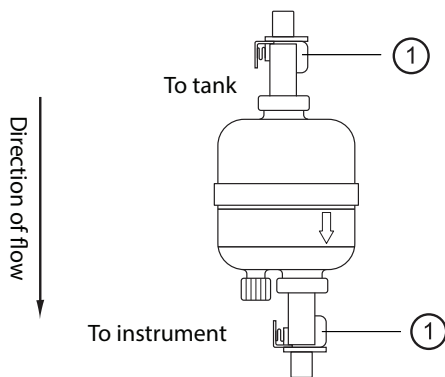

Item	Description
1	Tabs

5. Write the current date on the filter so that you will know when to replace it.
6. Use the arrows on the filters that indicate the direction of the flow through the filter; replace the filter with a new one in the same orientation.
7. Reconnect the air line and check for leaks when the pressure is turned on.

Changing the sample lines

The primary sample line between the sample injection chamber and the pinch valve should be changed every 4–6 months or when decreased event rates indicate that the sample line might be clogged. The secondary sample line between the pinch valve and the cuvette flow cell needs changing only when it is kinked or clogged.

As a precautionary measure, prior to opening the Flow Cell access door, use the **Stop** button in the laser control software to put the lasers in standby and then close the laser control software. This will turn off the laser diode, but will keep the diode temperature constant.

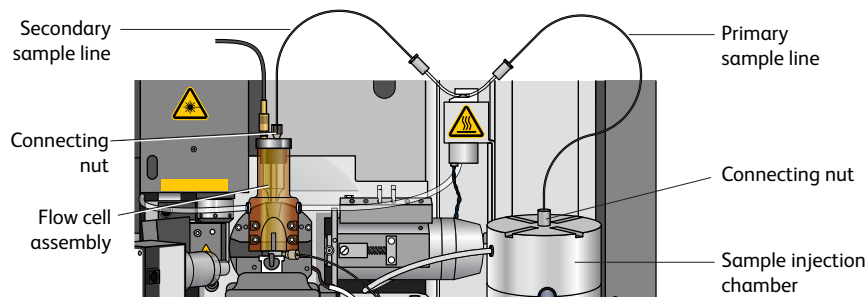

To withstand the high pressures generated by the BD FACSymphony™ S6 cell sorter flow cytometer, the sample lines are attached using a two-piece compression fitting, in which a cone-shaped ferrule is compressed onto the tubing as the connecting nut is tightened.

To replace the tubing, you will need a 12-inch length of replacement tubing for the primary sample line, or a 7-inch length for the secondary line. Replacement tubing is supplied in the accessory kit. The ferrules and connecting nuts can be reused when the tubing is replaced.



All biological specimens and materials coming into contact with them can transmit potentially fatal disease. Handle used tubing and fittings as if capable of transmitting infection. Wear suitable protective clothing, eyewear, and gloves.

Changing the primary sample line

To replace the primary sample line, you will need a 12-inch length of replacement tubing from the accessory kit. There is a different fitting at each end of the tubing, so the procedure is divided into two sections.

Assembling the collet fitting at the pinch valve

At the pinch valve end of the primary sample line, a collet fitting joins the sample line to the pinch valve tubing.

To replace the tubing:

1. As a precautionary measure, prior to opening the Flow Cell access door, use the **Stop** button in the laser control software to put the lasers in standby and then close the laser control software. This will turn off the laser diode, but will keep the diode temperature constant.
2. Turn the stream off (if needed). Make sure the loading port is in the unload position.
3. Unscrew the nut from the collet fitting and pull the nut and collet apart.
4. Pull the pinch valve tubing out of the nut, and then pull the sample line out of the pinch valve tubing.
5. Locate a new 12-inch piece of sample line tubing.

- a. Slide the collet over the pinch valve tubing, then slide the nut over the new sample line tubing.

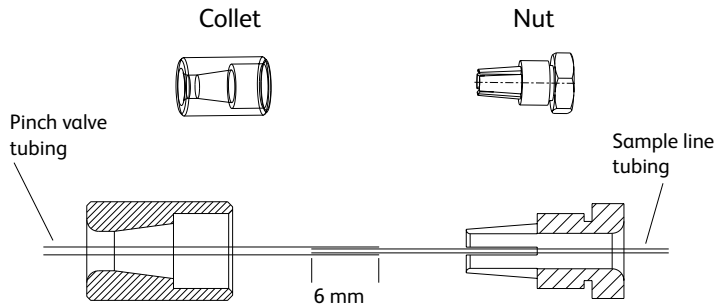

- b. Slide the pinch valve tubing over one end of the sample line tubing until approximately 6 mm of the sample line is inside the pinch valve tubing.
- c. Slide the pinch valve tubing on the inside of the teeth of the nut until it stops.



Ensure that the pinch valve tubing is inserted inside the teeth of the nut. Failure to do so can cause the bubble detector to malfunction.

- d. Couple both pieces of the fitting together and then tighten until finger-tight.

Primary sample line – sample injection end

At the sample injection end of the primary sample line, a compression fitting secures the sample line at the top of the sample injection chamber.

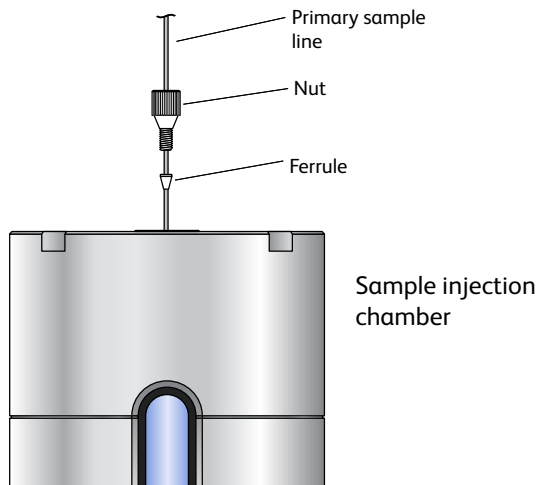

1. Turn the stream off (if needed). Make sure the loading port is in the unload position.
2. If there is a sample line filter installed, remove it by pulling it off the sample line.
To gain access to the filter, see [Installing or removing a sample line filter \(page 159\)](#).
3. Unscrew the connecting nut at the top of the sample injection chamber and slowly pull out the sample line.
4. Ensure that a cone-shaped ferrule is attached to the sample line.

If the ferrule was left behind in the injection chamber fitting, gently push the tip of the ferrule-removal tool (included in a small vial inside the accessory kit) into the top of the ferrule and pull the ferrule straight out.

After using the tool, you might need to replace the ferrule. If the ferrule is damaged, replace it with a spare (included in the accessory kit).



5. Slide the ferrule and nut off the end of the sample line.
6. Slide the nut and then the ferrule onto the end of the new sample tubing.
Leave approximately 5 inches (12.7 cm) of tubing extending out of the sample injection chamber end. (This length can be adjusted depending on the depth of your sample tube.) This length is referred to as the pilot.

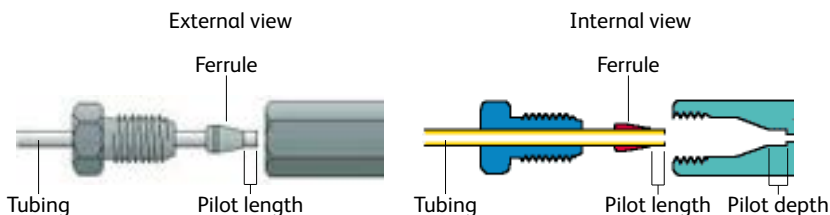

7. Insert the pilot tubing into its fitting, ensuring that the tubing reaches the intended pilot depth.



Do not to bend the primary sample line during insertion.

Insert the sample line into the sample injection chamber fitting. Push the tubing from the top until it is slightly above the bottom of the chamber viewing window. Finger-tighten the nut on top of the chamber so the sample line is secure.



Do not overtighten the nut and do not use tools. Over-tightening the nut can kink or damage the tubing.

8. Check the fitting connections at both ends to make sure they are not leaking.
Turn on the stream, load a tube of DI water, and make sure none of the fittings are leaking. If needed, unload the tube, turn off the stream, and tighten the fittings. After tightening, if leaking still occurs, replace the ferrule.



Make sure all fittings are securely tightened. If any fitting is loose, the tubing could detach during high-pressure operation, exposing the operator to potentially biohazardous sample spray.

9. Verify the length of the sample line.
The sample line should not bow or bend when a tube is loaded. If you need to adjust the length, unscrew the nut on top of the sample injection chamber, adjust the length, and tighten the nut again.
See [Installing or removing a sample line filter \(page 159\)](#) for detailed instructions on verifying sample line length. Disregard any steps that do not apply.

Changing the secondary sample line

This section describes changing the secondary sample line. There is a different fitting at each end of the tubing, so the procedure is divided into two sections.

As a precautionary measure, prior to opening the Flow Cell access door, use the **Stop** button in the laser control software to put the lasers in standby and then close the laser control software. This will turn off the laser diode, but will keep the diode temperature constant.

Pinch valve end

The procedure to replace the secondary sample line at the pinch valve end is the same as for the primary sample line, except the replacement line is a 7-inch length. See [Assembling the collet fitting at the pinch valve \(page 150\)](#).

Flow cell end

1. Turn the stream off.
2. Unscrew the connecting nut at the top of the flow cell and slowly pull out the sample line.

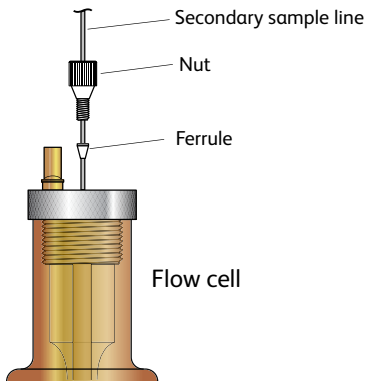

3. Ensure that a cone-shaped ferrule is attached to the sample line.
If the ferrule was left behind in the flow cell fitting, gently push the tip of the ferrule-removal tool (included in the accessory kit) into the top of the ferrule and pull the ferrule straight out.
After using the tool, you might need to replace the ferrule. If the ferrule is damaged, replace it with a spare (included in the accessory kit).
4. Slide the ferrule and nut off the end of the sample line.
5. Slide the nut and then the ferrule onto the end of the new sample tubing.
Leave approximately 0.1 inch (0.25 cm) of tubing extending out of the ferrule. This length is referred to as the pilot.
6. Insert the pilot tubing into its fitting at the top of the flow cell, ensuring that the tubing reaches the intended pilot depth.



Within the cuvette flow cell fitting, make sure the pilot is seated flush against the pilot depth. Dead volume between the pilot and the pilot depth can lead to sample carryover or leaking.

7. Finger-tighten the nut at the top of the flow cell to secure the sample line.



Do not overtighten the nut and do not use tools. Over-tightening the nut can kink or damage the tubing.

8. Check the fitting connections at both ends to make sure they are not leaking.

Turn on the stream, load a tube of DI water, and make sure none of the fittings are leaking. If needed, unload the tube, turn off the stream, and tighten the fittings. After tightening, if leaking still occurs, replace the ferrule.



Make sure all fittings are securely tightened. If any fitting is loose, the tubing could detach during high-pressure operation, exposing the operator to potentially biohazardous sample spray.

Changing the air filter

The BD FACSymphony™ S6 cell sorter has an air filter in the sort collection chamber door.

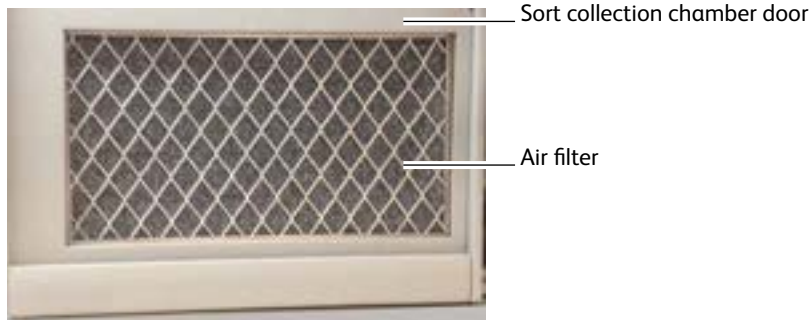

To change the filter in the sort collection chamber door, slide out the old filter and slide in the new one. To slide out the old filter, release the locking screw behind the door. See [Replacing the air filter \(page 199\)](#) for more information.

Changing the Sheath Tank Air Filter

Check the inline air filter on the sheath tank air line periodically for any signs of debris or discoloration. Replace with a new air filter from the accessory kit every six months, or sooner if needed.

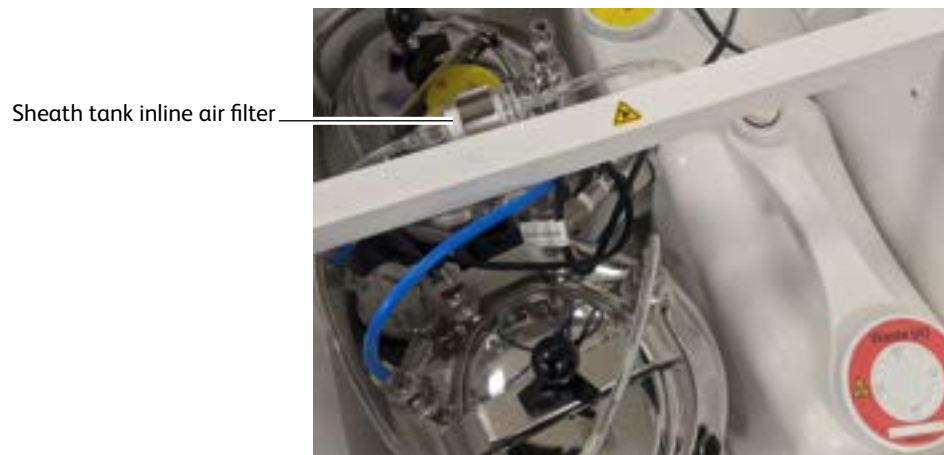

1. Turn off the cytometer.
2. Pull the tubing off each end of the air filter.
3. Install a new filter with the directional arrow pointing toward the sheath tank.

Unscheduled maintenance

There are several cytometer components that should be cleaned periodically or checked for wear and replaced if necessary. See the indicated sections for the following maintenance procedures.

Procedure	Recommended Frequency
Changing the integrated nozzle (page 155)	As needed for different sized particles
Cleaning the integrated nozzle (page 156)	When stream irregularities indicate that the nozzle is clogged
Temporary replacement of a seal (page 158)	As needed when seal is lost or damaged in an integrated nozzle
Closed-Loop Nozzle Maintenance (page 158)	As needed
Installing or removing a sample line filter (page 159)	When the sample line filter needs to be installed or changed
Changing the pinch valve tubing (page 161)	As needed
Cleaning the camera windows (page 163)	When smudges appear in the Breakoff or Side Stream windows
Removing the deflection plates (page 165)	As needed to clean the deflection plates
Lubricating the sample injection chamber O-ring (page 166)	As needed when the O-ring is dry
Using custom optical filters (page 167)	As needed
Cleaning the optical filters (page 168)	As needed when changing a filter
Removing or installing the FSC ND filter (page 168)	As needed

Changing the integrated nozzle

Three sizes of nozzles are provided with your cytometer: 70, 85, and 100 μm . A 130- μm nozzle can be ordered as an option. The size is marked on the nozzle. The closed-loop nozzle used for cleaning and shutdown procedures is also changed with this procedure.



Any cytometer surface that comes in contact with biological specimens can transmit potentially fatal disease. Use universal precautions when handling sorting hardware. Wear suitable protective clothing, eyewear, and gloves.

1. As a precautionary measure, prior to opening the Flow Cell access door, use the **Stop** button in the laser control software to put the lasers in standby and then close the laser control software. This will turn off the laser diode, but will keep the diode temperature constant.
2. Turn off the stream and open the flow cell access door.

3. Turn the nozzle-locking lever counterclockwise to the 9:00 position, and pull the nozzle out of the cuvette flow cell.

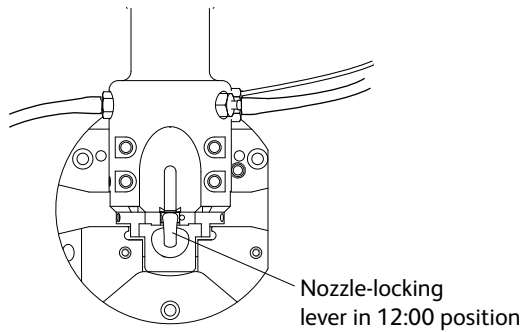

4. Insert the new nozzle into the flow cell (with the top side facing up) and push it gently all the way forward until it stops.
5. Turn the nozzle-locking lever clockwise to the 12:00 position.
6. Turn on the stream and make sure it flows smoothly from the nozzle into the center of the waste aspirator. If the stream is flowing but the breakoff is too long or the gap is unsteady, this could indicate that there are bubbles in the flow cell. If these conditions occur, turn off the stream, wait for 10 seconds, and turn on the stream again.

If you see any dripping or spraying, or the stream image appears abnormal, turn off the stream and see [Troubleshooting the stream \(page 170\)](#).

Note: After changing the nozzle, you might need to adjust the angle of the sort block to re-center the stream in the aspirator. To do so, loosen the adjustment screws on both sides of the deflection plates and rotate the sort block. Tighten the screws when the stream is centered in the aspirator. For further assistance, see [Troubleshooting the stream \(page 170\)](#).

Cleaning the integrated nozzle

Use the following procedure to clean the nozzle when the stream appears blocked or distorted. To verify that the nozzle is clogged, examine the opening at the center of the seal area under a microscope.

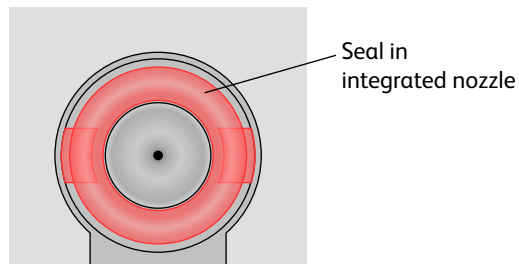

All biological specimens and materials coming into contact with them can transmit potentially fatal disease. Handle nozzles as if capable of transmitting infection. Wear suitable protective clothing, eyewear, and gloves.

To clean the integrated nozzle:

1. As a precautionary measure, prior to opening the Flow Cell access door, use the **Stop** button in the laser control software to put the lasers in standby and then close the laser control software. This will turn off the laser diode, but will keep the diode temperature constant.
2. Remove the nozzle from the flow cell by turning the nozzle-locking lever counterclockwise to the 6:00 position, then pull the nozzle straight out.
3. Sonicate the nozzle for approximately 1 minute in a test tube containing DI water. Repeat the sonication until the nozzle is clean.



Do not use bleach, Contrad[®], or any strong detergents to clean the nozzle.

4. Allow the nozzle to air dry for a few minutes. Do not wipe the nozzle with anything, because it could leave fibers or other contamination.
5. Insert the nozzle into the flow cell with top side facing up and push it gently forward until it stops.
6. Turn the nozzle-locking lever clockwise to the 12:00 position.
7. Turn on the stream and make sure it flows through the nozzle properly.

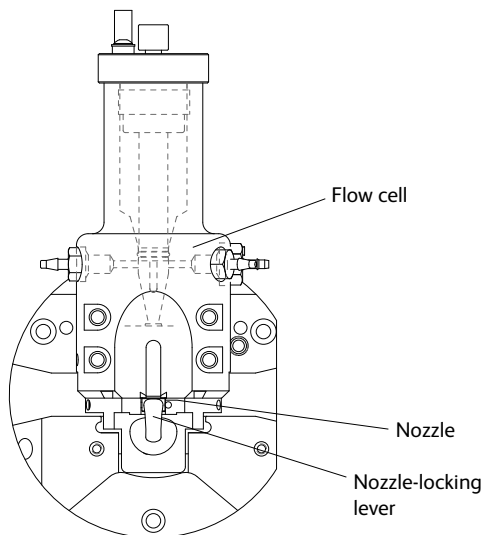

Note: After re-installing the nozzle, you might need to change the angle of the sort block to re-center the stream in the aspirator. To do so, loosen the adjustment screws on both sides of the deflection plates and rotate the sort block. Tighten the screws when the stream is centered in the aspirator. For further assistance, see [Troubleshooting the stream \(page 170\)](#).

Handling the integrated nozzle

In addition to following proper cleaning instructions, follow these precautions when handling the integrated nozzles.

Precaution	Result
Always use the integrated closed-loop nozzle for cleaning and shutdown procedures.	Keeps the flow cell clean and reduces the chances for clogs. A clean flow cell provides improved sensitivity and higher performance.
Do not expose integrated nozzles for long periods of time to bleach or detergents. However, you can prepare for the aseptic sort procedure without causing any problems to the O-ring in the integrated nozzle.	Prevents the seal from coming loose and falling out.
Do not expose integrated nozzles to strong base solutions such as Contrad 70.	Prevents the seal from coming loose and falling out. Any contact with such solutions might damage the seal.
Do not wipe the surface of the seal with anything.	Prevents damage to the seal that could result in leaking.

Temporary replacement of a seal

The standard O-ring can be used as a short-term replacement in the integrated nozzle, if the original seal has been lost or damaged, but a new integrated nozzle will provide better long-term usability. See [Accessory kit \(page 184\)](#) for part numbers for ordering integrated nozzles.

Standard O-rings (part number 333084) are supplied in the accessory kit. The following procedure describes how to install a standard O-ring in an integrated nozzle.

1. Make sure the groove in the nozzle is clean.
If the any part of the seal is still in the nozzle groove, sonicate the nozzle in a bleach solution until the seal comes out. Rinse the nozzle in DI water after sonicating.
2. Use the wooden end of a cotton swab, or similar tool, to install the O-ring in the nozzle groove, then allow the nozzle to air dry for a few minutes.
Do not wipe the nozzle with anything, because it could leave fibers or other contamination, or dislodge the O-ring.
3. Use the magnifier in the accessory kit, or a microscope, to inspect the nozzle to verify that the O-ring is installed all the way into in the groove.

Closed-Loop Nozzle Maintenance

The closed-loop nozzle and related tubing should be cleaned if there are any indications of clogging or kinked tubing.

Cleaning the integrated closed-loop nozzle

1. As a precautionary measure, prior to opening the Flow Cell access door, use the **Stop** button in the laser control software to put the lasers in standby and then close the laser control software. This will turn off the laser diode, but will keep the diode temperature constant.
2. Turn off the stream and open the flow cell access door.

- Remove the closed-loop nozzle from the cuvette flow cell.
Turn the nozzle-locking lever counterclockwise to the 6:00 position. Remove the nozzle by pulling it straight out.



- Unscrew the nut on the side of the nozzle to remove the tubing.
Make sure that the ferrule stays on the tubing as you remove it.
- Sonicate the nozzle for approximately 1 minute.
Sonicate the nozzle in a test tube containing DI water or a mild detergent. Repeat the sonication as needed until the nozzle is clean.
- Make sure that the ferrule is on the tubing, then screw the nut back into the hole in the side of the closed-loop nozzle.

Replacing the tubing on the closed-loop nozzle

To replace the tubing on the closed-loop nozzle, use this procedure. Use a 7-inch length of sample tubing from the accessory kit as the replacement.

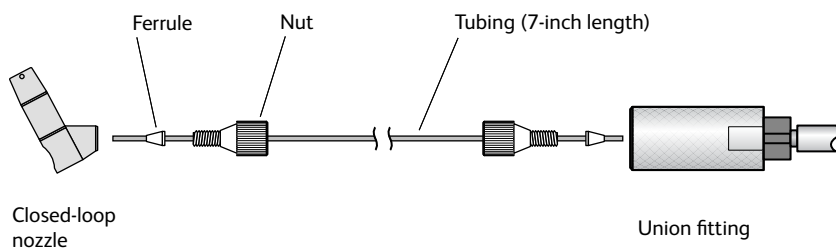

To replace the tubing:

- Unscrew the nut from the closed-loop nozzle and from the union fitting and pull out the tubing from both places.
Make sure that the ferrule comes out on the tubing on both ends. If not, use the ferrule tool to remove it.
- Slide the nut and ferrule off each end of the tubing.
- Slide the nut and ferrule onto the new tubing.
Insert the tubing into the closed-loop nozzle and slowly tighten the nut until secure. Do not over-tighten. Make sure that the tubing is pushed all the way in while tightening the nut.
- Insert the tubing into the union fitting and slowly tighten the nut until secure. Do not over-tighten. Pull gently on the tubing to ensure that it is secure.

Installing or removing a sample line filter

Sample filters can be installed on the end of the sample line to filter out large particles from a sample. Pre-filtering the sample before beginning any sorting is recommended.

Two sizes of sample line filters are included in the accessories kit: 35 micron (green) and 50 micron (blue). The filters can be changed as often as required. The sample filters are not intended for use with the 1-mL microtubes.

Note: When a sample filter is installed, the sample flow rate can be slowed down due to the effect of particles in the sample fluid clogging the filter.

1. With the stream turned on, select **Change Sample Filter** from the **Cytometer** menu.
2. A wizard opens with the instructions.

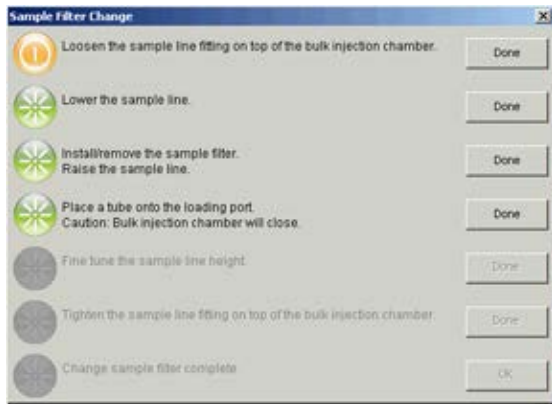

3. Loosen the sample line fitting nut at the top of the injection chamber to allow the sample line to slide freely through the fitting.

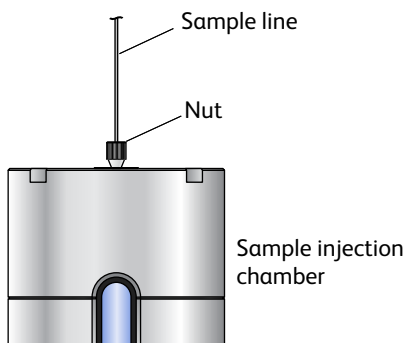

4. Push the sample line down so the end is below the bottom of the sample injection chamber.

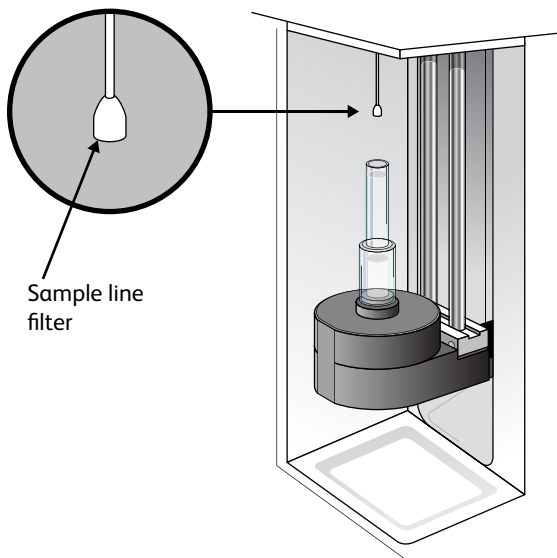

5. Install the sample line filter by sliding it onto the end of the line, then click **Done**.
Do not bend the sample line while installing the filter.
6. Pull the sample line up to operation height, slightly above the chamber viewing window.
7. Place a tube onto the loading port.



Movement of mechanical parts within the instrument can pinch or injure your hands or fingers. Keep your hands and clothing away from the loading port when a tube is loading or unloading. Do not place objects underneath the loading port.

8. Click **Done** to raise the sample injection chamber.



Be careful of a pinching hazard as the sample injection chamber is raised.

The sample line should not bow or bend when a tube is loaded.

9. Adjust the sample line height if needed.
10. Tighten the sample line fitting and click **Done**.
The bulk injection chamber is lowered and the sample purge mode is turned on for about 5 seconds until several drips exit the filter. A message is displayed at the bottom of the wizard.
11. Click **Done** to complete the process.

Changing the pinch valve tubing

The tubing that runs through the bubble detector and the pinch valve should be changed as needed. The system ships with replacement tubing cut into 3-inch lengths, found in the accessory kit.

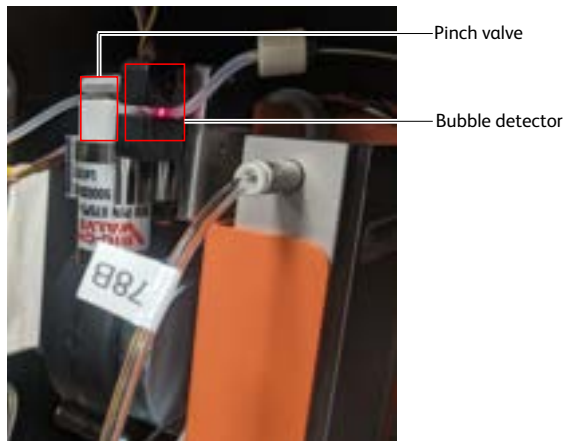

To replace the tubing:

1. As a precautionary measure, prior to opening the Flow Cell access door, use the **Stop** button in the laser control software to put the lasers in standby and then close the laser control software. This will turn off the laser diode, but will keep the diode temperature constant.
2. Turn off the stream. Make sure the loading port is in the unload position.
3. Pull the existing pinch valve tubing out of the slot in the pinch valve and the bubble detector. Grasp the tubing with two fingers next to the pinch valve and two fingers next to the bubble detector. Pull the tubing straight out from the slots. The tubing pops out with a small amount of pulling action.

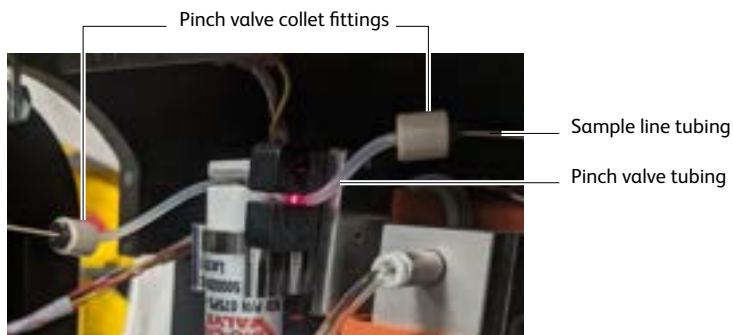

4. Unscrew the nut on the black collet fitting at each end of the tubing, and pull the pinch valve tubing out of both fittings. Leave both pieces of the fitting on the sample line tubing.
5. Install a new 3-inch piece of pinch valve tubing.
 - a. Slip the collet over one end of the new pinch valve tubing.
 - b. Slide the pinch valve tubing over the sample line tubing until approximately 6 mm of the sample line is inside the pinch valve tubing.
 - c. Slide the pinch valve tubing on the inside of the teeth of the nut until it stops.
 - d. Couple both pieces of the fitting together and then tighten until finger-tight.
 - e. Repeat steps a through d at the other end of the tubing.

- f. Check to see that both ends of the new pinch valve tubing are held securely in the compression fittings.

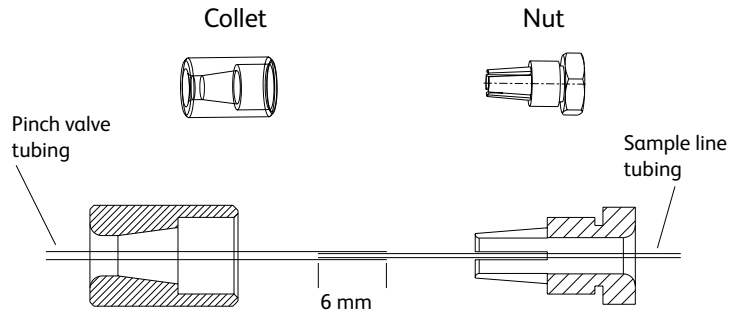

6. Install the new pinch valve tubing into the slots in the pinch valve and bubble detector.

Make sure that the tubing goes all the way into the back of each slot. The sample line can drip if the pinch valve tubing is not all the way into the slot in the pinch valve and the bubble detector.

Cleaning the camera windows

Lower camera window

Clean the lower camera window and the diode laser window when you have trouble viewing the side streams or you cannot set the drop delay using Accudrop.



A 12,000-volt potential exists between the deflection plates when they are on. Contact with the charged plates results in serious electrical shock. Do not touch the deflection plates when the plate voltage is on. The plates remain energized even when the sort block door is open.

To clean the lower camera window and the diode laser window:

1. As a precautionary measure, prior to opening the Flow Cell access door, use the **Stop** button in the laser control software to put the lasers in standby and then close the laser control software. This will turn off the laser diode, but will keep the diode temperature constant.
2. Ensure that the deflection plates are turned off (warning light is not illuminated).
3. Turn off the stream.
4. Open the sort block door.
5. Wipe the windows with a soft, lint-free cloth soaked with DI water, and then dry the windows.

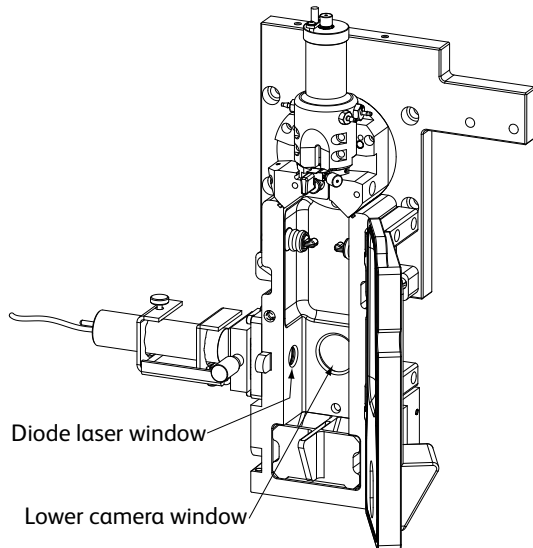

Upper camera window

Clean the strobe lens and upper camera window when smudges appear in the processed (digitized) image in the Breakoff window, or when dark spots appear to interfere with Sweet Spot monitoring. You might need to clean these components after a clog, or after sheath fluid has leaked or sprayed. Follow the steps in this section to clean the strobe lens and upper camera window.



A 12,000-volt potential exists between the deflection plates when they are on. Contact with the charged plates results in serious electrical shock. Do not touch the deflection plates when the plate voltage is on. The plates remain energized even when the sort block door is open.

To clean the strobe lens and upper camera window:

1. As a precautionary measure, prior to opening the Flow Cell access door, use the **Stop** button in the laser control software to put the lasers in standby and then close the laser control software. This will turn off the laser diode, but will keep the diode temperature constant.
2. Ensure that the deflection plates are turned off (warning light is not illuminated).
3. Turn off the stream.
4. Open the sort block door.
5. Place 1–2 drops of DI water or ethanol on a cotton swab.
6. Click the **Breakoff** window and select **Raw Image**.

Visible smudges are more apparent in the raw image view.

7. While viewing the image in the **Breakoff** window, insert the swab just below the bottom of the flow cell. The strobe lens and upper camera windows are located behind two circular openings on either side of the top of the sort chamber. You will see the end of the swab in the Breakoff window when you intercept either opening.

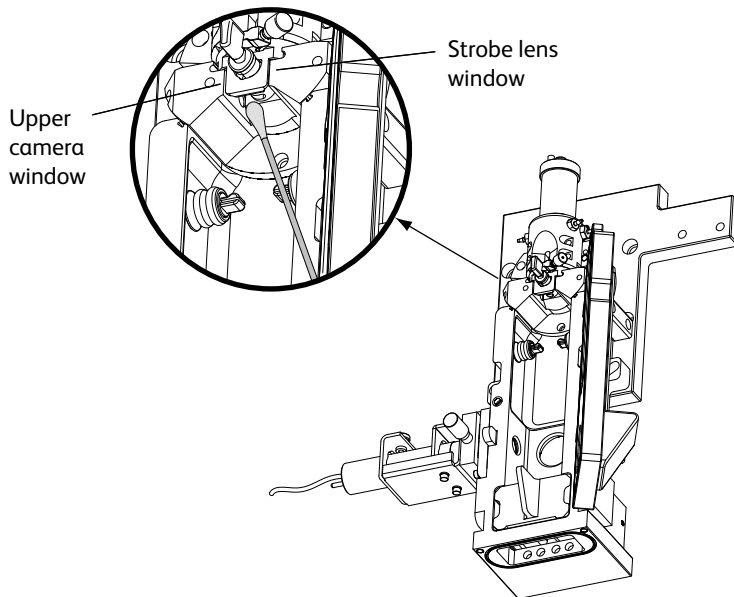

8. Gently wipe the upper camera window, and then the strobe lens (opposite the window) to remove any saline.
9. Repeat with isopropyl alcohol or 70% ethanol until clean.

Removing the deflection plates

You can remove the deflection plates for cleaning by pulling the plates out using the deflection plate removal tool, supplied in the accessory kit.



1. As a precautionary measure, prior to opening the Flow Cell access door, use the **Stop** button in the laser control software to put the lasers in standby and then close the laser control software. This will turn off the laser diode, but will keep the diode temperature constant.
2. Make sure that the deflection plates are turned off.
3. Open the sort block door.
4. Slide the deflection plate removal tool behind one of the plates and pull straight out from the sort block. Hold your thumb on the plate (or use your other hand) as you pull it out so it does not fall as you remove it.

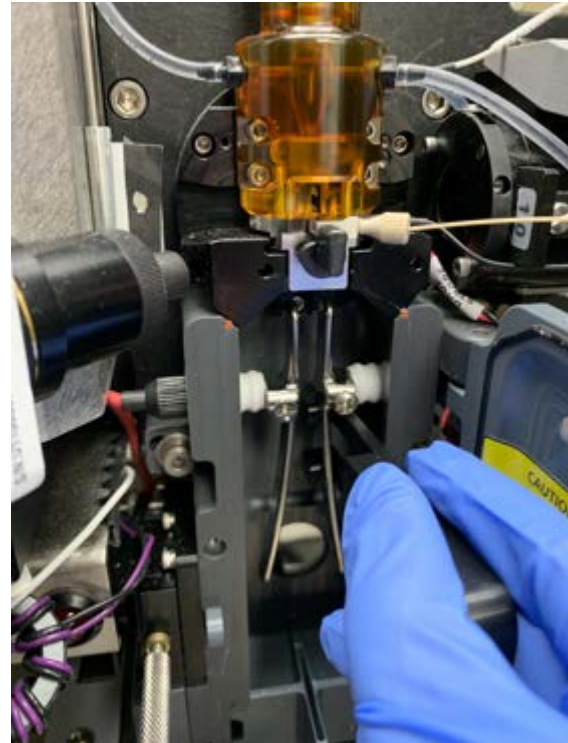
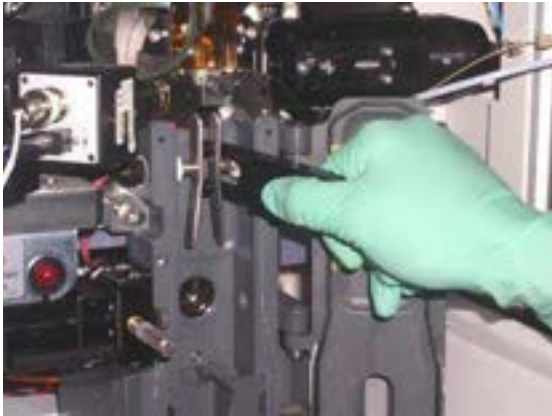

Lubricating the sample injection chamber O-ring

The O-ring at the bottom of the sample injection chamber should be lubricated as needed to maintain proper operation.

1. Verify that the loading port is in the down position, and open the hinged cover.
2. Check the O-ring (located at the opening in the bottom of the chamber) to see if it is dry.
3. If the O-ring is dry, it must be lubricated with O-ring lubricant from the accessory kit.
 - a. Remove the clear plastic tube holder from the tube holder base.
 - b. Apply a small amount of O-ring lubricant to the outside beveled edge of the tube holder base. This is where the base contacts the O-ring inside the sample injection chamber.
 - c. Wipe off any excess lubricant.

- d. Replace the tube holder on the base.

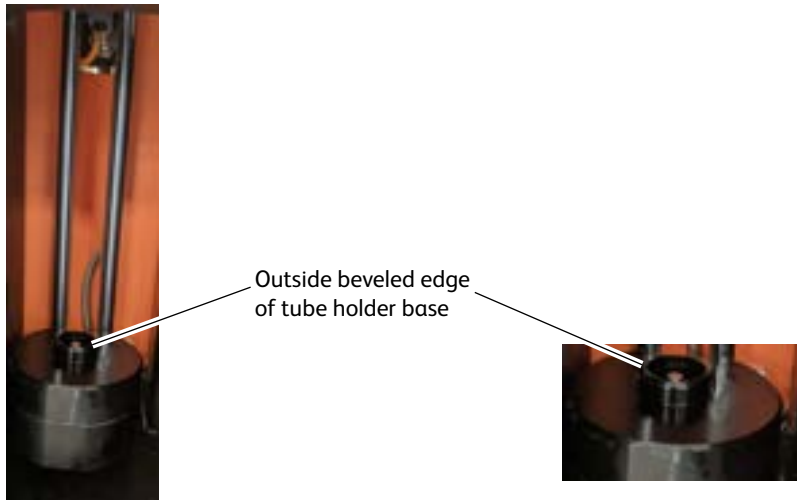

Using custom optical filters

If you want to install a custom filter or dichroic, the filter should comply with the following specifications.

Filter Characteristic	Dichroic LP Filters	BP Filters	Glass Filters
Diameter	0.492 in. (12.5 mm)	0.492 in. (12.5 mm)	0.492 in. (12.5 mm)
Thickness	0.16 ±0.005 in. (0.408 ± 0.127 mm)	0.079 in. (2.00 mm)	0.098 in. (2.5 mm)
Minimum clear aperture	0.562 in. (14.3 mm)	0.85 in. (21.6 mm)	
Incident angle	11 ±1°	0°	

For the longpass filters, the surface that faces the center of the HPC should be coated directly on its surface, not between two or more pieces of glass. The coating should transmit >70% of the wavelength range you want the filter to transmit, with a minimum transmission of >50%, and it should reflect >90% of the wavelength range you want the filter to reflect.

The opposite surface (facing away from the center) should be coated with an anti-reflective coating with a minimum reflection of £1% of the wavelength range you want the filter to reflect.

Note: Filters must be installed in front of each PMT to block unwanted laser light. For the dichroic, carefully assemble the glass filter in the holder using the retaining spring. Assemble the filter as per the supplier's specification. The angle of the dichroic is critical to achieving optimal results.

Note: Whenever you modify the filter set on your cytometer, you will need to create a new cytometer configuration to identify which PMT (identified by laser color and letter) will detect the emitted light. See [Custom configurations \(page 61\)](#) for instructions.

Cleaning the optical filters

Optical filters should be inspected occasionally and cleaned as necessary. The frequency will depend on how often the filters are handled.



When cleaning or replacing a filter, handle with care to avoid scratching the surface and to prevent the filter from falling out of the holder. Use cotton swabs, optical lens paper, and spectral-grade methanol or absolute ethanol in a dropper bottle (do not use acetone) to clean the optical filters.

1. Wrap a triangular section of the lens paper around the cotton end of a cotton swab. Moisten and seal the end with a few drops of alcohol.
2. Holding the cotton swab in a horizontal position, gently rub any spots on the filter surface and wipe clean.
3. Allow the solvent to evaporate and check the filter surface for streaks.
4. Inspect a ¼-inch-diameter section in the center of the filter for scratches.
Filters are coated with different dielectrics that can get scratched. If you see scratches, replace the filter.
5. Insert the cleaned filter into the HPC array.
Make sure the filters are pushed all the way in.

Removing or installing the FSC ND filter

For applications involving large particles in which events appear off scale on the FSC axis with a voltage of zero, keep the FSC ND filter in place to decrease the FSC signal and keep the events on scale. For applications involving small particles (for example, bacteria or platelets), you might need to remove the FSC ND filter as follows.

1. As a precautionary measure, prior to opening the Flow Cell access door, use the **Stop** button in the laser control software to put the lasers in standby and then close the laser control software. This will turn off the laser diode, but will keep the diode temperature constant.
2. Open the flow cell access door.
3. Locate and pull out the FSC ND filter.

The filter is installed at the left end of the FSC detector block, just to the right of the flow cell. To remove the filter, loosen the set screw and pull the filter out of the slot.

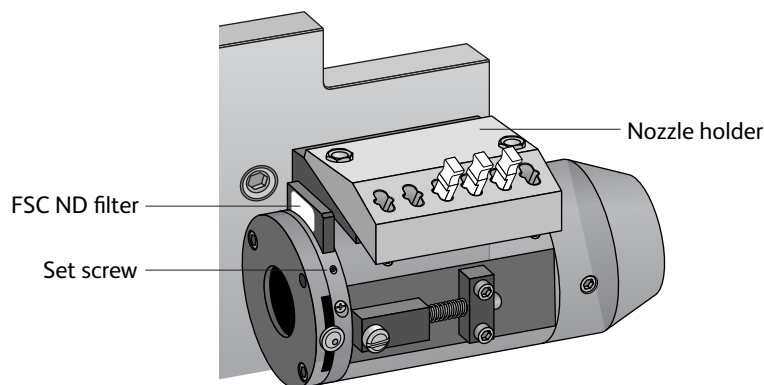

4. To reinstall the filter, slide it into the slot with the filter side down and the label facing the flow cell.

Note: You can remove the nozzle holder to get better access to the ND filter slot.

8

Troubleshooting

The tips in this chapter are designed to help you troubleshoot your experiments. Additional troubleshooting information can be found in the *BD FACSDiva™ Software Reference Manual*.

Note: As a precautionary measure, prior to opening the Flow Cell access door, use the **Stop** button in the laser control software to put the lasers in standby and then close the laser control software. This will turn off the laser diode, but will keep the diode temperature constant.

If additional assistance is required, contact your local BD Biosciences technical support representative. See [Technical assistance \(page 9\)](#).

Troubleshooting suggestions in this chapter are grouped under the following headings:

- [Troubleshooting the stream \(page 170\)](#)
- [Troubleshooting the breakoff \(page 173\)](#)
- [Sorting troubleshooting \(page 174\)](#)
- [Acquisition troubleshooting \(page 177\)](#)
- [Fluidics troubleshooting \(page 181\)](#)
- [Electronics troubleshooting \(page 182\)](#)

Troubleshooting the stream





Observation	Possible Causes	Recommended Solutions
Stream not in center of aspirator	Difference in keyed stream position between nozzles	If you have just changed the nozzle, use an Allen wrench to loosen the screws on either side of the sort block. Adjust the angle of the sort block until the stream flows into the center of the waste aspirator, and then tighten the screws.
	Nozzle inserted improperly	Turn off the stream. Remove the nozzle and ensure that the seal or O-ring is in place. Re-insert the nozzle and slide the nozzle in until it stops, then close the locking lever.
	Clogged or damaged nozzle	Turn off the stream, remove the nozzle, and examine the nozzle tip under a microscope. <ul style="list-style-type: none"> • If debris is visible, clean the nozzle. See Cleaning the integrated nozzle (page 156). • If the nozzle appears damaged, replace it. See Changing the integrated nozzle (page 155).
Plate arcing with no events thereafter	Arcing error comes from the droplet board (not from the fluidics board). Board will turn everything off to prevent destroying plates and for circuit protection. If no notification is sent to the board, the software will not reset the board.	Dry the plates and sort block. Reset the instrument and software.
Performance check failed	Incorrect filters	Confirm that the filters used during the performance check match the filters used to define the baseline.
No stream or dripping stream	Nozzle inserted improperly	Turn off the stream. Remove the nozzle. See Changing the integrated nozzle (page 155) for instructions.
	Clogged or damaged nozzle	Turn off the stream, remove the nozzle, and examine the nozzle tip under a microscope. <ul style="list-style-type: none"> • If debris is visible, clean the nozzle. See Cleaning the integrated nozzle (page 156). • If the nozzle appears damaged, replace it. See Changing the integrated nozzle (page 155).
Stream control disabled or no stream when stream control clicked	Air lock in fluidics filter	Prime the system with the corresponding fluid. If the control is still disabled, remove the filter, install the bypass tubing, and repeat the priming procedure until you see fluid in the line. When fluid is running through the line, remove the bypass tubing, install the filter, and repeat the priming procedure one last time.
	Communication failure between workstation and cytometer	Exit the software and restart it.

Observation	Possible Causes	Recommended Solutions
No stream when Stream control clicked	Sheath tank low or empty	Refill the sheath tank. See Refilling the sheath tank (page 94) . NOTE When the empty tank warning message is not closed after 15 minutes, the stream shuts off automatically.
	Air in sheath line	Prime the sheath tank. See Prime after tank refill (page 145) .
	Air in sheath filter	Purge the sheath filter. See Purging the sheath filter (page 148) .
	Dry filter	Open the bleeder valve to purge the filter. See Purging the fluid filters (page 148) .
Fanning around center stream	Nozzle inserted improperly	Re-insert the nozzle. Push it gently all the way forward without rocking it from side to side.
	House air or compressor is off (gauge reads zero)	Turn on house air or compressor.
	Sheath tank lid not properly seated (gauge reads <80 psi)	Remove sheath tank lid, reseal properly.
Unstable stream	Debris in flow cell or nozzle	Remove the nozzle and run the stream with no nozzle in place for approximately 10 seconds. (Click the Stream control on, then off.) Sonicate the nozzle and re-install it.
	Fluid line connected to ethanol shutdown tank	Move fluid and air lines to the sheath tank, then perform a fluidics startup. See Performing fluidics startup (page 90) .
Stream stops shortly after starting stream	Interlock cable is disconnected	Check cable. Call BD Service.
Stream stops when loading tube	Sample Injection Chamber obstructed Sample Injection Chamber misaligned	Check tube loading area is clear. Check chamber base O-ring is properly seated. Call BD Service.
Stream stops after tube unloads	Sample Injection Chamber obstructed Sample Injection Chamber misaligned	Check that nothing is below the Sample Injection Chamber base. Ensure Sample Injection Chamber skin is positioned all the way back. Call BD Service.
Stream stops randomly	Emergency Off switch pressed	Reset switch. Call BD Service.
Leaking or spraying around nozzle	Defective or damaged integrated nozzle seal	Replace the defective seal with a standard O-ring. See Temporary replacement of a seal (page 158) .
	Nozzle inserted improperly	Turn off the stream. Remove the nozzle. See Changing the integrated nozzle (page 155) for instructions.
	Extra O-ring is blocking the nozzle	Remove the nozzle and use a cotton swab to clear out the cuvette.
Drop breakoff is too long	Bubbles in flow cell	Open the flow cell access door and check for bubbles in the flow cell. If they are visible, turn off the stream, wait a few seconds, and turn on the

Observation	Possible Causes	Recommended Solutions
		stream again.
	Attenuation is on	Turn off attenuation.
	Amplitude is too low	Increase the amplitude until you can see drops. If you need a very high amplitude (>70 volts) to see drops, there might be air bubbles in the flow cell.
	Nozzle inserted improperly	Turn off the stream. Remove the nozzle and ensure that the seal or O-ring is in place. Re-insert the nozzle and slide the nozzle in until it stops, then close the locking lever.
Problems using Auto Delay feature	Stream is not stable	Make sure that the stream is stable before starting to run auto delay.
	Diode laser does not fully intercept the sorting streams	Adjust the diode laser to intercept streams in the middle, producing the biggest and brightest spots in the left and center images.
	Event rate is too low or too high	Adjust the flow rate to increase or decrease the event rate.

Troubleshooting the breakoff

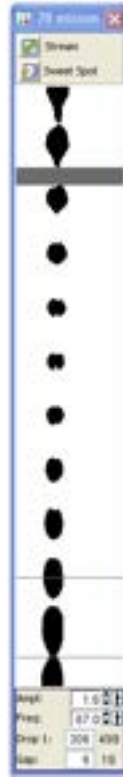
Use the following examples to help troubleshoot problems with the breakoff image.

Normal stream image	Abnormal Stream Images					
						
	<p>Possible Causes</p>	<p>Nozzle inserted improperly</p>	<p>Nozzle inserted improperly or orifice is off center</p>	<p>Partial clog</p>	<p>Wet or dirty strobe lens</p>	<p>Attenuation is on at wrong pressure</p>
	<p>Recommended Solutions</p>	<p>Remove the nozzle and re-insert it.</p>	<p>Remove the nozzle and re-insert it.</p>	<p>Remove the nozzle, clean it, and then re-insert it.</p>	<p>Clean the lens as described in Cleaning the camera windows (page 163).</p>	<p>Turn off attenuation in the Side Stream window.</p>

Sorting troubleshooting

Observation	Possible Causes	Recommended Solutions
Unstable breakoff while Sweet Spot is engaged	Residual ethanol in system	Allow the system to run until the breakoff stabilizes.
	Target Drop 1 value is out of range for drop spacing	Use an actual Drop 1 value for the target. Remember to repeat the drop delay setup each time the target value is changed.
	Nozzle is clogged or inserted improperly	See Responding to a nozzle clog during a sort with the AMO (page 195) .
	Dirty strobe lens or upper camera window	Clean the lens and the window as described in Cleaning the camera windows (page 163) .
	Air in sheath filter	Purge the sheath filter. See Purging the sheath filter (page 148) .
	Debris in flow cell or nozzle	Remove the nozzle and run the stream with no nozzle in place for approximately 10 seconds. (Click the Stream control on, and then off.) Sonicate the nozzle and re-install it.
Center stream image is dim or not visible in the Side Stream window	Camera window is dirty	Clean the lower camera window. See Cleaning the camera windows (page 163) .
	Stream is not intercepting the diode laser	Adjust the micrometer dial on the laser to make the stream intercept as bright as possible.
Center stream is off center when the plate voltage is turned on	Voltage center too low or too high	Adjust the Voltage Center slider to put the center stream back to center.
	Saline spray on deflection plates or in sort block	Clean the deflection plates and the area around them.
Arcing between deflection plates	Salt bridge	Clean and dry the deflection plates and the area around and behind the plates.

Observation	Possible Causes	Recommended Solutions
ACDU sorting failure	Insufficient stream voltage	Increase the voltage for the far left stream.
	Splash shield not installed	Install the splash shield. See Installing the sorting hardware (page 132) .
Side stream position reversal, where the streams appear to be associated with the wrong voltage slider.	Voltage sliders are set too far in or too far out.	Move sliders in or out so they control the correct side streams.
No deflection or insufficient deflection	Insufficient voltage	<ul style="list-style-type: none"> • Increase the side-stream voltages using the slider controls. • Increase the plate voltage.
	Stream-charging wire is loose or missing	Verify that the stream-charging wire is inserted all the way into the barb.
	Salt bridge	Turn off the stream. Remove the nozzle. See Changing the integrated nozzle (page 155) for instructions.
	Sorting paused because actual Drop 1 value is out of range	<p>Wait until the Sweet Spot adjusts the amplitude to achieve the Drop 1 target.</p> <p>If this happens repeatedly during sorting, there might be debris in the nozzle or flow cell. See Troubleshooting the stream (page 170) for suggestions.</p>
Fanning around center or side streams	Nozzle inserted improperly	Turn off the stream. Remove the nozzle and ensure that the seal or O-ring is in place. Re-insert the nozzle and slide the nozzle in until it stops, then close the locking lever.
	Incorrect Gap	Turn off the Sweet Spot and adjust the Gap amplitude to a value that is midway between the outer limit tolerances. Turn on the Sweet Spot after the adjustment.
	Sweet Spot is off	Turn on the Sweet Spot.
	Incorrect sort precision mode	Verify that the sort precision mode is appropriate for your sorting requirements. See Sort Precision Modes (page 52) .
	2nd, 3rd, or 4th Drop values not optimized	Adjust the 2nd, 3rd, and 4th Drop settings to tighten the center stream and fine-tune the side streams.
	Particles too big for nozzle	Change the nozzle. See Changing the integrated nozzle (page 155) .
Sort button disabled	Current tube pointer not set to current tube	Click to move the current tube pointer to the appropriate tube.
Population not listed in Add menu on sort layout	Population defined using snap-to gate	Redefine the population using another gate type.
	Viewing sort layout for another tube	Open or create a sort layout for the current acquisition tube.

Observation	Possible Causes	Recommended Solutions
Sort layout counters not updating	Viewing sort layout for another tube	Open or create a sort layout for the current acquisition tube.
High sort conflict rate	Event rate is too high for drop drive frequency	Decrease the event rate.
	Gating conflict	Verify the gating hierarchy.
	Purity mask is too high	Decrease the purity mask.
Erratic sort rate	Flow rate is too high	Decrease the flow rate.
Unexpected sort results	Incorrect drop delay	Reset the drop delay. See Determining the drop delay – automatic method (page 126) .
	Incorrect sort precision mode	Verify that the sort precision mode is appropriate for your sorting requirements. See Sort Precision Modes (page 52) .
	Sweet Spot is off	Keep the Sweet Spot on during sorting.
	Drop 1 changed after setting drop delay	Reset the drop delay each time you change the Drop 1 value. See Determining the drop delay – automatic method (page 126) .
	Laser delay changed after setting drop delay	Reset the drop delay each time you change the laser delay. See Determining the drop delay – automatic method (page 126) .
	Incorrect logic in population hierarchy	Verify the gating strategy.
	Sorting parent and child populations into two different tubes	<p>If you try to sort a parent and its child population into two tubes, BD FACSDiva™ software ignores the child events in both tubes.</p> <p>Create a new subset under the parent population consisting of NOT (child). Sort the child population into one tube and the NOT (child) population into another tube.</p>

Acquisition troubleshooting

Observation	Possible Causes	Recommended Solutions
No events in plots after clicking Load or Acquire Data	Current tube pointer is not set to current tube	Click to move the current tube pointer to the appropriate tube.
	Laser shutter is engaged	Make sure the flow cell access door is completely closed.
	Laser power is off	Turn on the laser power.
	Laser delay set incorrectly	Adjust the laser-delay settings. See Manual adjustment of laser delay (page 116) .
	Viewing plots for a different tube	Double-click the current tube in the Browser to display the plots for that tube.
	Incorrect population(s) in plot	Right-click the plot and select Show Populations. Verify that the appropriate populations are displayed.
	Uncolored events in plot	<ul style="list-style-type: none"> Format the plot to display all events. Assign a color to the population displayed in the plot. Verify the population drawing order.
	Current cytometer configuration different from optical setup	Verify that the cytometer optics match the current cytometer configuration.
	No sample in the tube	Add sample to the tube or install a new sample tube.
	Sample is not mixed properly	Increase the sample agitation rate. See Sample agitation (page 57) .
Sample line is clogged	Perform a sample line backflush. See Sample line backflush (page 145) . If necessary, change the sample line.	

Observation	Possible Causes	Recommended Solutions
No events in plots after clicking Acquire Data (continued)	Sample filter is clogged	Replace the sample filter.
	Threshold not set to the correct parameter (usually FSC)	Set the threshold to the correct parameter for your application.
	Multiple threshold parameters not set correctly	Verify that the correct Boolean logic (And/Or) was used for the threshold parameters.
	Threshold channel too low or too high	Adjust the threshold channel. See Calculating compensation (page 110) .
	Optical filter(s) not completely seated	Make sure that the filters are pushed all the way in.
	FSC area scaling is incorrect	Ensure that the FSC-A matches the FSC-H value.
No fluorescence signal	Current cytometer configuration different from optical setup	Verify that the cytometer optics match the current cytometer configuration.
	Wrong filter installed or filter not completely seated	Make sure that the appropriate filter is installed for each fluochrome. Make sure that the filters are pushed all the way in.
	Laser delay is set incorrectly	Adjust the laser-delay settings. See Manual adjustment of laser delay (page 116) .
Low area signal	Area scaling is too low	Adjust area scaling for the corresponding laser. See Adjusting area scaling (page 104) .
Unexpected events in plot	Incorrect logic in population hierarchy	Verify the gating strategy.
	Incorrect population (s) in plot	Right-click the plot and select Show Populations. Verify that the appropriate populations are displayed.
	Incorrect drawing order	Verify that the required population is not hidden by another population. Right-click the plot and select Order Populations by Count.
Erratic event rate	Sample aggregates	Filter the sample.
	Bulk injection O-ring is worn	Contact your BD Biosciences service engineer.
	Sample is contaminated	Re-stain the sample, making sure the tube is clean.
	Sheath tank low	Fill the sheath container.
Unexpectedly high event rate	Threshold channel is too low	Adjust the threshold channel. See Calculating compensation (page 110) .
	Sample is too	Dilute the sample.

Observation	Possible Causes	Recommended Solutions
	concentrated	
	Flow rate is too high	Decrease the flow rate in the Acquisition Dashboard.
	Bubbles in flow cell	Turn off the stream, wait a few seconds, and turn on the stream again.
Unexpectedly low event rate	Sample not adequately mixed	Increase the sample agitation rate. See Sample agitation (page 57) .
	Threshold channel is too high	Adjust the threshold channel. See Calculating compensation (page 110) .
	Sample is too dilute	Concentrate the sample.
	Sample line is clogged or kinked	Backflush the sample line. See Sample line backflush (page 145) . If necessary, change the sample line.
		Look for visible kinks in the line. If kinks are found, change the sample line. See Changing the sample lines (page 150) .
Unexpectedly low event rate (continued)	Sample line installed incorrectly	Verify the sample line installation. See Changing the sample lines (page 150) .
	Sample aggregates	Filter the sample.
	Memory is full	Compare the processed event rate in BD FACSDiva™ software with the threshold counter. If the event rate is much lower, exit and then restart the application.
Distorted populations or high CVs	Cytometer settings adjusted incorrectly	Optimize the scatter parameters. See Calculating compensation (page 110) .
	Flow rate is too high	Decrease the flow rate in the Acquisition Dashboard.
	Window extension is too low	Increase the window extension.
	Bubbles in flow cell	Turn off the stream, wait a few seconds, and turn on the stream again.
	Nozzle is clogged or dirty	Clean the nozzle as described in Changing the integrated nozzle (page 155) .
	Flow cell is dirty	Clean the flow cell. See Cleaning the flow cell (daily) (page 140) . Let DI water sit for 15 minutes before turning on the stream. Repeat as needed.
	Poor sample preparation	Repeat sample preparation.
	Area scaling is too low	Verify area scaling. See Adjusting area scaling (page 104) .
Excessive amount of debris in plots	Threshold channel is too low	Increase the threshold channel. See Calculating compensation (page 110) .
	Dead cells or debris in sample	Examine the sample under a microscope.

Observation	Possible Causes	Recommended Solutions
	Sample is contaminated	Re-stain the sample, making sure the tube is clean.
High electronic abort rate (>10% of system event rate)	Window extension is too high	Decrease the window extension.
	Threshold channel is too low	Increase the threshold channel.
	Event rate is too high	Decrease the flow rate in the Acquisition Dashboard.
	Sample is aggregated	Filter the sample.
	Sample is too concentrated	Dilute the sample.
Fewer events than expected in gated population	Window extension set incorrectly	Adjust the window extension, if needed. See the <i>BD FACSDiva™ Software Reference Manual</i> for information.
	Laser delay set incorrectly	Adjust the laser-delay settings. See Manual adjustment of laser delay (page 116) .
	Plot is zoomed	Unzoom the plot or make the gate bigger.
	Events left out of the gate	When drawing a gate, make sure that events on the axis are included.
Increasing threshold results in decreased area signal	Window extension is too low	Slightly increase the window extension to maximize the area signal. Increasing the window extension too much results in more electronic aborts or high CVs.
Area measurement off scale while the height measurement is on scale	Area scaling is too high	Decrease area scaling to move the area measurement back on scale. If necessary, adjust area scaling to make the area measurement match the height measurement.
Cannot delete from Parameters, Threshold, Compensation, or Ratio tab views	Row not selected	Select the row using the selection button.
	Data already recorded	Create a new tube.
Cannot connect to CS&T	External air supply is <80 PSI	Check the air pressure gauge on the air supply panel or sheath tank. The air pressure should be 80–100 PSI. <ul style="list-style-type: none"> If the air pressure is within range, contact your BD Biosciences service engineer. If the air pressure is <80 PSI, close the release valve and reseal the lid.
Negative Q values	Higher power lasers than in previous cell sorters	<ol style="list-style-type: none"> Rerun the CST baseline. When the software pauses at the Optimized PMT Results window, set median channel values that are <200 to 200. Click OK to finish the run.

Fluidics troubleshooting

Observation	Possible Causes	Recommended Solutions
No fluid in line during system prime	Air lock in sheath or fluidics filter	Remove the filter for the corresponding fluid, install the bypass tubing, and run Prime After Tank Refill. Repeat the priming procedure until you see fluid in the line. When fluid is running through the line, remove the bypass tubing, install the filter, and repeat the priming procedure one last time.
Prepare for aseptic sort fails	Air lock in filter	Remove the filter for the corresponding fluid, install the bypass tubing, and run Prime After Tank Refill. Repeat the priming procedure until you see fluid in the line. When fluid is running through the line, remove the bypass tubing, install the filter, and repeat the priming procedure one last time.
	Fluid line is detached	Verify the fluid line connections on the fluidics drawer and on the cytometer. Push firmly on each line to ensure that it is connected.
Fluidics air flow <80 PSI	Air leak	Contact your BD Biosciences service engineer.
Fluidics air flow >100 PSI	Regulator not adjusted properly	Contact your BD Biosciences service engineer.
Fluid leak under fluidics drawer or below side door	Condensation from pressure relief valve	This is a normal phenomenon that occurs when water is condensed from room air. Condensation is greater in humid environments. To avoid slipping, wipe up any water daily.
	Bleeder valve is open	Check and close all bleeder valves for fluid and sheath filters.
	Broken fluid line	Contact BD Biosciences.
Sample injection chamber does not close and causes a BISH or BISO error message	O-ring at bottom of sample injection chamber is dry and causing chamber to stick	Lubricate the O-ring and tube holder. See Lubricating the sample injection chamber O-ring (page 166) .

Electronics troubleshooting

Observation	Possible Causes	Recommended Solutions
“Cytometer Disconnected” in Cytometer window	Cytometer power is off	Turn on the cytometer main power.
	Communication failure between workstation and cytometer	<ul style="list-style-type: none"> Exit the software and then restart it. If restarting does not work, reset the cytometer electronics: switch off the main power, wait 10 seconds until the system is fully depressurized, and then switch the power back on. Restart the computer and the cytometer.
	Ethernet cable between workstation and cytometer is disconnected	Unplug and then plug in the cable connectors and make sure they are secure.
	IP address changed	Enter the correct IP address. Call BD Biosciences for assistance.
Lasers are not powered on	Main laser power button is not switched on.	Switch the main laser power button on.
	USB data loss.	Unplug and replug the USB cable at the side of the sorter.
“Master DAQ Overflow” in Cytometer window	Event rate is too high	Decrease the event rate or verify the threshold.
	Dirty flow cell	Clean the flow cell. See Cleaning the flow cell (daily) (page 140) .
“Cytometer not responding” in Status tab	Unknown	Perform the suggestions for a communication failure, above.

9

Supplies and consumables

This chapter provides a list of supplies and options that are available for the BD FACSymphony™ S6 cell sorter.

- To order spare parts and consumables from BD Biosciences from within the US, call 877.232.8995 or go to bdbiosciences.com.

Outside the US, contact your local BD Biosciences representative.

- To order cytometer options, contact your sales representative.

This information is correct at the time of publication. For up-to-date information, see our website (bdbiosciences.com).

- [Cytometer supplies \(page 184\)](#)
- [Consumables \(page 188\)](#)

Cytometer supplies

Accessory kit

The cytometer is shipped with an accessory kit containing the following items. Use these part numbers if you need to order any replacements.

Tank-related parts

Item	Part Number
Waste sensor probe (6-level)	334915
Auxiliary 5-L container	333504
Baffle for 10-L waste tank (2 pack)	338505
Cap for 5-L container (3)	335916
Sheath tank assembly	641915
Ethanol tank assembly	641916
Auxiliary sensor probe (ethanol)	642874
O-ring, tank, ethyl and sheath	642877
Wet cart liquid filter	644320
Disposable waste tank caps (pack of 12)	338854
Waste tank with label	643909
Ethanol tank with label	643910
DI water tank with label	643911
BD FACSClean™ tank with label	643912
Sheath sensor probe	644109
Pressure gauge, 0-100 PSI	646024
Pipe fitting, 0.25 in.	645400
Vacuum lid utility knob	648233
Ball knob, 1 in. diameter	642833
Auxiliary sensor probe (non-ethanol)	343835

Optical Filters

Item	Part Number
FSC 0.5 neutral density filter assembly	337104
FSC 1.0 neutral density filter assembly	337108
FSC 1.5 neutral density filter assembly	338651
FSC 2.0 neutral density filter assembly	338652
Filter (Chroma) HQ710/50	640471
Mirror (Omega) 675/20	19-62774-15
Filter holders (3)	336102
Filter clip (5)	640563

Sort collection devices

Item	Part Number
15-mL centrifuge tube holder	333430
12 × 75-mm test tube holder	333456
Six-way 5-mL amber tube holder	500050957
Six-way 5-mL tube holder top	500050958
Six-way 1.5-mL tube holder	665647
1-mL microtube holder	333457
Four-way 12 × 75-mm collection tube holder	641454
Two-way 12 × 75-mm collection tube holder	500032421
Two-way 15-mL collection tube holder	641612
Four-way 1-mL collection tube holder	641614
Splash guard	641615
Temp control 15-mL tube holder	647168
Temp control 12 × 75-mm tube holder	647206
Temp control Eppendorf tube holder	647207
Four-way 1.5-mL Eppendorf collection tube holder	644349
Terasaki plate adaptor	652905
Adapter tray for microscope slides	335630
Six-way 5-mL temp control tube holder	665346

Maintenance-replacable items

Item	Part Number
Sample injection tubing (12-in. lengths)	641059
Sample injection tubing (7-in. lengths)	641475
Standard nozzle O-rings	333084
Ferrule	335108
Capsule filter 0.2 micron	336945
O-ring for collection-tube holder, 1.75 in. internal diameter, 1.87 in. external diameter (9)	337897
O-rings 0.176 in. internal diameter, 0.318 in. external diameter (10)	340086
Drop charge cable assembly	343358
Barbed Fitting, 1/4-28 in. × 1/16 in. internal diameter tubing (3)	343508
Lubricant for O-rings	347306
Peek nut fitting	348578
O-rings 0.859 in. internal diameter (3)	641860
Pinch valve tubing	641900
Reducing union fitting 1/16 in. – 1/32 in.	643571
Rotary shaft seal	644054
Universal top section for collection tube holders (2)	651439
Coupling insert valved 1/4 in.	641543
Tube compression fitting 3/8 in. through	641920
Coupling body valved 1/4 in.	641542
Window BI sort head	657582
Fitting street tee 1/4M × 1/4F × 1/4hex	657798
Collet	19-66455-00
Collet nut large diameter	663282
Connector female luer to 10/32 in.	59-10102-00
Collet nut	19-66456-00
Sort block deflection plate, left 2.5 in.	642579
Sort block plate deflection plate, right 2.5 in.	640042
Sort block deflection plate, left 3.5 in.	5000061176
Sort block deflection plate, right 3.5 in.	5000061177

Cables

Item	Part Number
Power cords: <ul style="list-style-type: none"> • Main power cord • Cordset for continental Europe • Cordset for UK • Cordset for Australia/Asia 	<ul style="list-style-type: none"> • 333694 • 334140 • 334141 • 334175
R1 CAT-5 cable	334965
Coaxial cable BNC-M to BNC-F 2 ft.	342824
Cable, extension, DB9FEM-DB 8 ft.	332907

Nozzles

Item	Part Number
Closed loop nozzle assembly	644395
Integrated nozzles: <ul style="list-style-type: none"> • 70 micron (2) • 85 micron (2) • 100 micron 	<ul style="list-style-type: none"> • 647339 • 647340 • 647341
Nozzle holster	642884
Nozzle locking lever (spring and plunger included)	7001349

Tools

Item	Part Number
Plastic O-ring pick tool	331430
Ferrule-removal tool	335690
Magnifying glass	337599
Tool alignment 1.5-mL side stream	658214
Deflection plate removal tool	643197
Hex wrench set	98-10004-00

Other replacement parts

The following items may not be included in the accessory kit, but you can use the indicated part numbers to order spare or replacement parts.

Item	Part No.
Autoclavable 10-L container	340261
Warning labels	335600

Consumables

Cytometer setup particles

Particle	Supplier	Catalog No.
BD Calibrite™ Beads	BD Biosciences	
<ul style="list-style-type: none"> Two-color kit (unlabeled, FITC, PE) 		<ul style="list-style-type: none"> 349502
<ul style="list-style-type: none"> Three-color kit (unlabeled, FITC, PE, PerCP) 		<ul style="list-style-type: none"> 340486
<ul style="list-style-type: none"> PerCP beads 		<ul style="list-style-type: none"> 340497
<ul style="list-style-type: none"> PerCP-Cy5.5 beads 		<ul style="list-style-type: none"> 345036
<ul style="list-style-type: none"> APC beads 		<ul style="list-style-type: none"> 340487
Fluoresbrite® Yellow-Green 2-µm beads (for the 405-nm laser)	Polysciences Inc. (800) 523-2575	18604
Spherotech Rainbow Calibration Particles, 3.0–3.4 µm	BD Biosciences	<ul style="list-style-type: none"> 559123 (8 peaks) 556286 556291 (brightest peak in 556286)
BD FACS™ Accudrop Beads	BD Biosciences	345249
BD FACSDiva™ CS&T Research Beads	BD Biosciences	641319 (1 vial) 642412 (3 vials)

Reagents

Reagent	Supplier	Catalog No.
BD FACSTow™ sheath fluid	BD Biosciences	342003
BD® Detergent Solution Concentrate	BD Biosciences	660585
Detergent liquid cond	BD Biosciences	99-30109-00
BD FACSClean™ solution	BD Biosciences	340345
Ethanol	Various	–
Chlorine bleach (5% sodium hypochlorite)	Clorox® or other major supplier (to ensure that the bleach is at the correct concentration and free of particulate matter)	–
Monoclonal antibodies	BD Biosciences ^a	–
Dyes and fluorochromes	Life Technologies (800) 438-2209 Sigma (800) 325-3010	–
BD FACS™ Lysing Solution	BD Biosciences	349202

^aSee the BD Biosciences Immunocytometry Products Catalog or the BD Biosciences website, bdbiosciences.com.

Labware

Item	Supplier	Catalog No.
1-mL microtubes	Bio-Rad Laboratories (800) 424-6723	223-9391 (1,000 per box)
1.5-mL Eppendorf tubes	Various	–
5-mL polystyrene test tubes, 12 × 75-mm <ul style="list-style-type: none"> • Uncapped, 125 per bag • Capped, 125 per bag • Capped, 25 per bag • With cell-strainer cap, 25 per bag 	BD Biosciences	<ul style="list-style-type: none"> • 343675 • 352054 • 352058 • 352235
15-mL conical centrifuge tubes <ul style="list-style-type: none"> • Polypropylene, 50/bag • Polypropylene, 125/bag • Polypropylene, 50/rack • Polystyrene, 125/bag • Polystyrene, 50/rack 	BD Biosciences	<ul style="list-style-type: none"> • 352196 • 352096 • 352097 • 352095 • 352099

AMS/AMO consumables

Item	Part Number
Air filter for ACPU cabinet (set of 3)	334821
ULPA filter and tubing replacement kit (set of 3)	334822
Pre-filter	333595
Hydrophobic filter for sort block door, 0.2 micron, 25 mm	651177

BD FACSymphony™ S6 Cell Sorter consumables

Item	Part Number
Swab, micro head 3.2 × 1.5 × 10, 70-mm LG (100/pkg)	643290
Cotton-tipped applicators (100/pkg)	99-30122-00
Air filter, inline, 0.3 micron (2)	641913
Sample inline filters (35 micron) Qty 50	649048
Sample inline filters (50 micron) Qty 50	649049
Hydrophobic filter for sort block door, 0.2 micron, 25 mm	651177
Sheath fluid filter (also used for ethanol shutdown tank filter)	661744

10

BD[®] Aerosol Management Option

The BD[®] Aerosol Management Option (AMO) is a device that uses an attached vacuum source to rapidly evacuate aerosolized particles through an ultra-low penetrating air (ULPA) filter during routine sorting or analysis.

The following topics are described in this chapter:

- [Option components \(page 192\)](#)
- [Operating the BD[®] Aerosol Management Option \(page 193\)](#)
- [Maintenance \(page 196\)](#)
- [Upgrades for the AMO \(page 200\)](#)
- [Troubleshooting the AMO \(page 201\)](#)
- [Specifications \(page 203\)](#)

Option components

The BD® Aerosol Management Option (AMO) includes the following:

- An evacuator to generate negative pressure
- An ULPA filter to trap particles, with attached tubing that connects the evacuator to the instrument
- An air filter for the sort collection chamber door
- A hydrophobic filter on the sort block door
- A hinged cover on the sample injection chamber



The BD® Aerosol Management Option does not eliminate the health risks of working with biohazardous material and must be used in conjunction with good laboratory practice.

The BD® Aerosol Management Option is for research use only. It is not for use in diagnostic or therapeutic procedures.

Evacuator

The evacuator holds the ULPA filter and attached tubing. Air flow is controlled using pushbuttons within a membrane panel on the front of the unit. The evacuator sits on caster wheels for easy maneuverability. It can be moved using the handle attached to the unit.

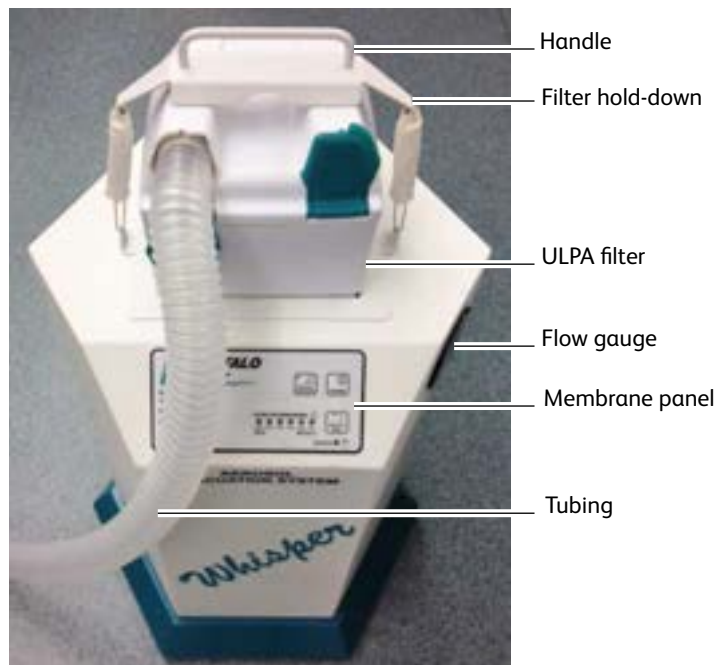

ULPA filter

The ULPA filter used in the BD AMO captures and retains 99.9995% of all particles down to and including particles 0.12 microns in size, according to the manufacturer's specifications.

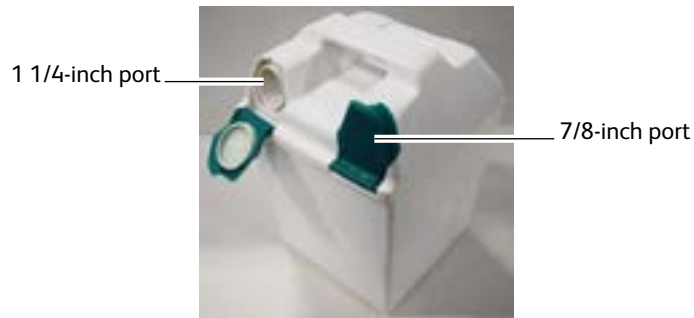

Operating the BD® Aerosol Management Option

Starting up the evacuator

Before starting up the evacuator, make sure that:

- The ULPA filter is completely seated against the bottom of the evacuator filter well
- One end of the tubing is securely attached to the 1 1/4-inch (left) port on the ULPA filter

Note: Ensure that the 7/8-inch (right) port is closed.

- The other end of the tubing is attached to the manifold located in the connection panel on the back of the cytometer



Any instrument surface that comes in contact with biological specimens can transmit potentially fatal disease. Use universal precautions when handling instrument hardware. Wear suitable protective clothing, eyewear, and gloves.

To start up the evacuator:

1. Install the splash shield or the tube holder below the aspirator drawer.

The splash shield is required for sorting into a multiwell plate or onto a slide.

To install the splash shield:

- a. Remove the tube holder, if one is installed.
- b. Insert the splash shield into the slotted fittings below the sort aspirator drawer. Push the splash shield all the way in.

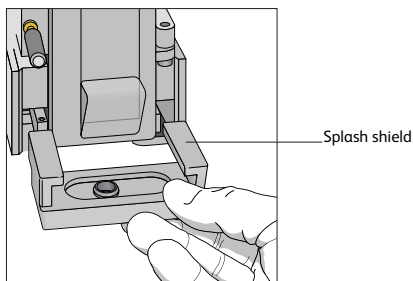

2. Ensure that an air filter is installed in the sort collection chamber door.

The filter traps airborne dust that could clog the ULPA filter. The filter should be changed on a monthly basis. See [Replacing the air filter \(page 199\)](#).

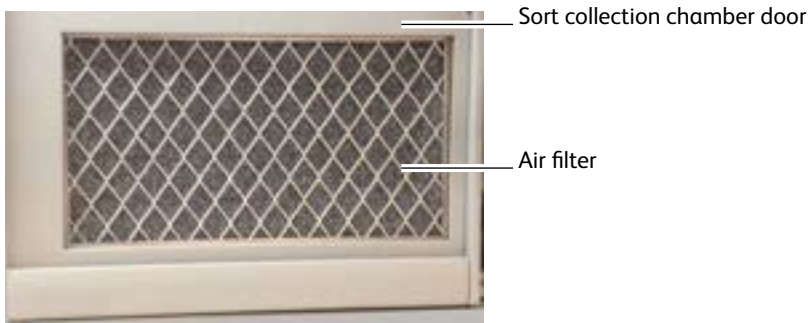

- Close the sort collection chamber door.

Note: The sort collection chamber door must be closed for the evacuator to generate negative pressure in the chamber.

- Switch on the main power on the back of the evacuator.

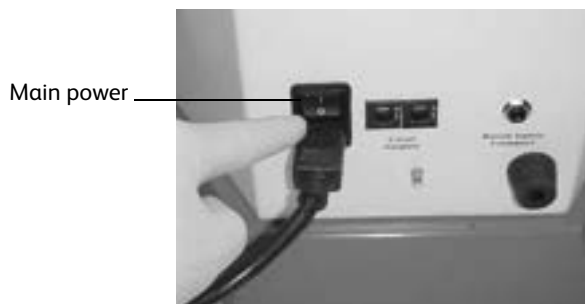

- Press the power button on the membrane panel of the evacuator.



- Press the up or down arrow button to set the suction control rate to 20%.

Each time either arrow button is pressed, the suction will increase or decrease by 10%. When two lights are lit on the suction control indicator, the actual air flow is the value between the two illuminated percentages.



Do not set the suction control rate above 20%. Higher rates could affect the stability of the side streams.

- Verify that the filter flow gauge reads less than 2.4 inches of H₂O.

For a new filter, the gauge should read 1.1–1.4 inches of H₂O. As the filter is used, the reading will increase. If the gauge reads 2.4 inches of H₂O or greater, replace the filter. See [Replacing the ULPA filter \(page 197\)](#).



New filter



Used filter

Setting up for sorting

To set up for sorting:

1. Start up the flow cytometer system. See [Cytometer startup \(page 88\)](#).
2. Start up the evacuator as described in [Starting up the evacuator \(page 193\)](#).
3. Follow the standard sort setup procedure. See [Setting up for sorting \(page 120\)](#).

Always start up the evacuator before setting up for sorting. If you start up the evacuator after sort setup is complete, you will need to repeat the setup procedure.

Responding to a nozzle clog during a sort with the AMO

If the stream is disturbed during the sort (due in part to a clogged nozzle), the sort is designed to stop automatically and block the sort tubes (if Sweet Spot is on). The sort will not restart until the operator has cleared the clog. In the event of a nozzle clog, do not open the sort collection chamber door or access the sort tubes before following this procedure.



Cell sorters that use droplet generation methods, such as the BD FACSymphony™ S6 cell sorter, can produce aerosols around the sample stream. When acquiring biohazardous samples, follow universal precautions at all times. Keep the sort block door and the sort collection chamber door closed during sorting. Follow these steps to stop sample flow and evacuate potential aerosols before opening the sort collection chamber door.

To clear a clogged nozzle on a system with the AMO:

1. If the stream has not already shut down automatically, turn off the stream by clicking the **Stream** button (with a checkmark) at the top of the **Breakoff** window.
This will shut off the stream, unload the sample, and close the aspirator drawer.
2. Increase the air evacuation rate on the AMO unit to 100%.
3. Open the aspirator drawer using software controls.
4. Wait at least 60 seconds.
This procedure will clear aerosols from the sort chamber.
5. Close the aspirator drawer.
6. Turn on the stream and view the breakoff.
If the clog is removed, the breakoff will be similar to the breakoff before the clog.
7. If the clog is not cleared, turn the stream on and off several times to see if the clog will clear itself.

8. If the clog is not removed, turn the stream off and perform the Clean Flow Cell procedure with DI water (see [Cleaning the flow cell \(daily\) \(page 140\)](#)), followed by turning the stream on to see if the clog has cleared.
9. Open the aspirator drawer and evacuate for at least 60 seconds before closing the aspirator drawer again.
10. You can now open the sort collection chamber and remove the sort collection device.
11. If it is necessary to change nozzles or remove a clog from a nozzle, see [Cleaning the integrated nozzle \(page 156\)](#).
12. With stream turned off, open the sort block door and dry the plates and surfaces as needed.
13. When removing collection tubes, be aware that the outside of the tube is potentially contaminated. Use alcohol swabs or bleach to wipe the outsides of tubes.
14. Set the AMO unit back to 20% vacuum.
15. Make sure that all chamber doors are closed and restart the stream.
16. Perform these tasks if needed:
 - Turn on the Sweet Spot
 - Check the drop delay
 - Check the side stream deflection

Turning off the evacuator

Turn off the evacuator after you have finished running biohazardous samples.

1. Place the system in standby by pressing the power button on the membrane panel of the evacuator.
2. Switch off the main power on the back of the evacuator.

Maintenance

Use the following guidelines to ensure optimal performance of the BD[®] Aerosol Management Option.

- Change the ULPA filter and attached tubing when the flow gauge indicator is >2.4 at a 20% flow setting or when the red filter-life indicator LED is blinking. See [Replacing the ULPA filter \(page 197\)](#).

Two spare filters and replacement tubing are included with the AMO. To order additional replacement kits, contact your local BD Biosciences representative.



All biological specimens and materials coming into contact with them can transmit potentially fatal disease. Handle the ULPA filter and attached tubing as if capable of transmitting infection. Dispose of waste using proper precautions and in accordance with local regulations. Wear suitable protective clothing, eyewear, and gloves.

- Change the air filter in the sort collection chamber door on a monthly basis. The filter traps airborne dust that could clog the ULPA filter. Regular replacement of the air filter will extend the life of your ULPA filter. See [Replacing the air filter \(page 199\)](#).
- Do not touch the Filter Life Reset button during normal operation. Doing so could shut down the evacuator and prevent the collection of aerosols.
- Do not disconnect the tubing from the instrument manifold outlet or the ULPA filter unless you are changing the filter. Repeated removal and reattachment of the tubing could loosen the connection and disrupt airflow.
- To ensure optimal airflow, keep the tubing free of kinks and away from sharp or heavy objects. Do not crush or puncture the tubing. Ensure that the tubing is securely attached at both ends before turning on the evacuator power.

- Keep the sort collection chamber free of potentially obstructive debris, such as Kimwipes® or disposable pipets.
- Replace the hydrophobic filter on the sort block door every six months.

Replacing the ULPA filter

Replace the filter when either of the following conditions occur:

- The filter-flow gauge reads 2.4 inches of H₂O or greater at 20% suction.
- The red filter-life indicator LED is blinking.

Note: When only the red LED light is illuminated (but is not blinking), you have approximately 1 hour of filter life remaining. If the red light comes on during sorting, the filter will not stop working. Replace the filter as soon as possible when the red light starts blinking.

To replace the ULPA filter:

1. Turn off the evacuator main power and disconnect the electrical plug.



To prevent potential shock, always turn off the evacuator main power and disconnect the electrical plug from the power source before installing or removing any filter.

2. Disconnect the tubing from the manifold.

The manifold is located in the connection panel on the back of the cytometer.

3. Remove the spring-loaded filter hold-down.

While pushing down on the filter, pull up on the spring-loaded handle, and guide the handle over the top of the filter and behind the metal plate in the back of the evacuator.

Note: The photos in this section show the discontinued ULPA filter. The new ULPA filter has two ports (1 1/4-inch and 7/8-inch).

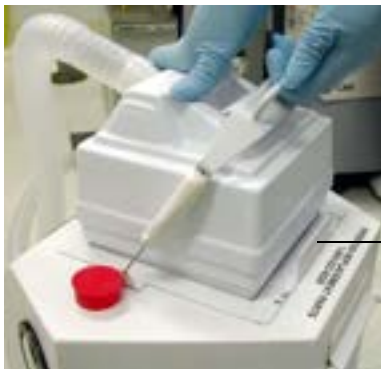

Metal plate



4. Lift off the ULPA filter and attached tubing from the evacuator and dispose of both the filter and the tubing.



All biological specimens and materials coming into contact with them can transmit potentially fatal disease. Handle the ULPA filter, attached tubing, and all instrument hardware as if capable of transmitting infection. Dispose of waste using proper precautions and in accordance with local regulations. Wear suitable protective clothing, eyewear, and gloves.

5. Insert the new ULPA filter into the evacuator filter well.



6. Push down on the filter to ensure that it is seated against the bottom of the filter chamber.



Note: For optimal evacuation of aerosols, the filter must be completely seated in the evacuator filter well.

7. Lift the spring-loaded filter hold-down and place it on top of the filter.
8. Press and hold the Filter Life Reset button on the membrane panel for 5-10 seconds.



All of the green, amber, and red LED lights will turn off, and then on. Hold down the button until the 100% indicator light is lit. This resets the 180-hour filter-life clock.

Note: As the life of the filter is exhausted, the indicator lights will go out, starting from 100%. When only the red LED light is illuminated (but is not blinking), you have approximately 1 hour of filter life remaining.

9. Connect one end of the replacement tubing to the 1 1/4-inch (left) port on the ULPA filter, and the other end to the tubing manifold on the back of the cytometer.
Ensure that the cover on the 7/8-inch (right) port is closed.



Note: For optimal evacuation of aerosols, ensure that the tubing is securely connected at both ends.

10. Connect the evacuator power plug to the power source.

Replacing the air filter

To extend the life of your ULPA filter, we recommend that you replace the air filter on a monthly basis. The filter traps airborne dust that could clog the ULPA filter. Regular replacement of the air filter will extend the life of your ULPA filter.

The air filter is located inside the sort collection chamber door.

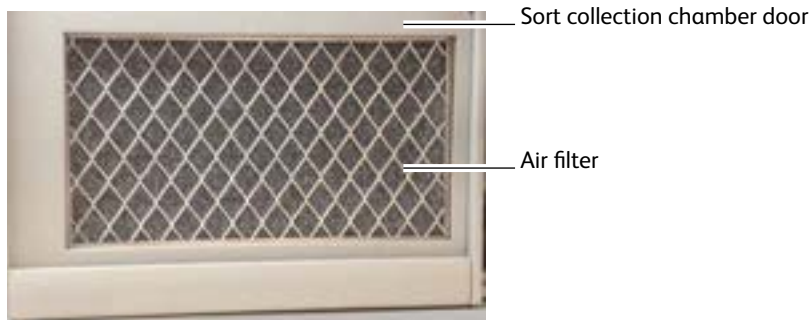

To replace the air filter:

1. Slide open the sort collection chamber door.
The air filter is held in place by a cover.

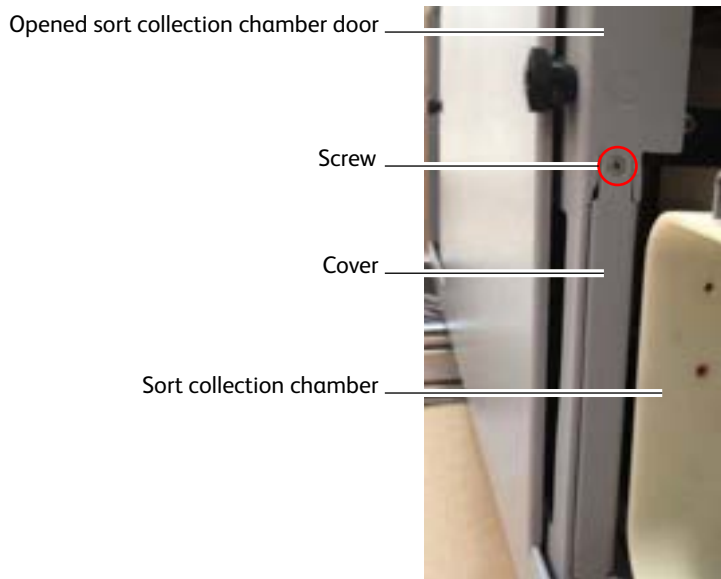

2. Unscrew the screw at the top of the cover.
3. Pull off the cover and slide out the air filter.

Grasp the filter and then carefully slide it out of the door. While it is still inside the BSC, bag the air filter to avoid exposure to biohazardous agents.



All biological specimens and materials coming into contact with them can transmit potentially fatal disease. Handle the air filter and all instrument hardware as if capable of transmitting infection. Dispose of waste using proper precautions and in accordance with local regulations. Wear suitable protective clothing, eyewear, and gloves.

4. Install a new air filter in the door.
Slide the new filter in from the right.

Note: Make sure to install the filter with the grid side facing out so that it is visible through the closed door.



Grid side faces out



Non-grid side faces in

5. Reinstall the cover and tighten the screw.

Upgrades for the AMO

Upgrade kits are available for the AMO to improve the efficiency of the system to clear aerosols that can be produced during the sorting process. The components include a new tube holder top section with three holes and a hydrophobic filter for the sort block door.

Contact BD Customer Support for information on the upgrade kits.

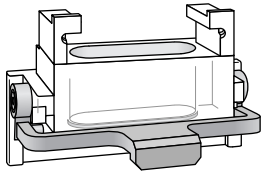

Universal top (front view)

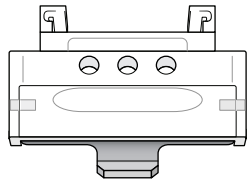

Universal top (back view)

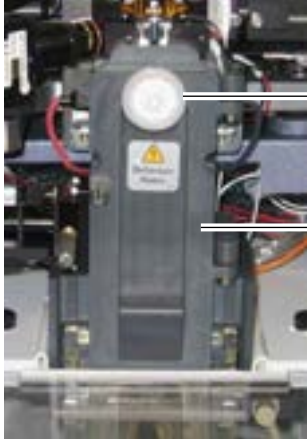

Hydrophobic filter,
included with AMO

Sort block door

Troubleshooting the AMO

The tips in this section are provided to help you troubleshoot issues that arise when using the BD® Aerosol Management Option. For cytometer-specific troubleshooting, see [Troubleshooting \(page 169\)](#).

If additional assistance is required, contact your local BD Biosciences technical support representative or supplier.



If any of the following are observed, assume that the AMO is not evacuating properly, and do not open the doors to the sort chamber.

Control Panel Troubleshooting

Observation	Possible Cause	Recommended Solution
Evacuator indicator lights off	Evacuator power cord unplugged	Connect the evacuator power cord to the power source.
	Evacuator power switched off	Switch on the evacuator main power.
	Evacuator motor failure	Contact your local BD technical support representative.
	Circuit breaker tripped	Depress the circuit breaker on the rear of the evacuator into its original position.
	Site power failure	Turn off the evacuator power switch and wait for site power to be restored.
Evacuator indicator lights pulsing	Erratic power source	Plug the power cord into a different outlet.
Arrow keys not responding	Improper operation	Push each button firmly before removing your finger from the control.
	Defective membrane panel	Contact your local BD technical support representative.
Red filter-life indicator light on	Approaching 180 hours of filter use	Monitor the light. When it blinks, change the filter.
	Filter life not reset after filter change	After changing the filter, press and hold the Filter Life Reset button until the 100% indicator light is lit.
Red filter-life indicator blinking	Filter used over 180 hours	Replace the filter.

Filter Flow Gauge Troubleshooting

Observation	Possible Cause	Recommended Solution
Zero reading on filter flow gauge	Power off	Press the power button on the membrane panel of the evacuator.
	Filter defective	Replace the filter.
	Filter improperly seated in evacuator	Re-seat the filter with the evacuator power off.
	Tubing loose or not connected	Ensure that the tubing is securely connected below the sort chamber and to the filter module.
	Tubing kinked or damaged	Inspect the tubing for kinks or punctures. Replace the tubing, if needed.
	Wrong tubing type or part	Ensure that the correct type of tubing is in use.
Erratic reading on filter flow gauge	Defective filter	Replace the filter.
	Filter improperly seated in evacuator	Re-seat the filter with the evacuator power off.
Off-scale reading on filter flow gauge	Tubing or sort collection chamber obstructed	<ul style="list-style-type: none"> Inspect the tubing for kinks or punctures. Replace the tubing, if needed. Check for obstructions in the sort collection chamber. Remove any obstruction.
	Filter clogged or saturated	Replace the filter as described in Replacing the ULPA filter (page 197) .

Specifications

Specifications for the BD® Aerosol Management Option are as follows.

Evacuator

- Greater than or equal to 7 CFM (ft³/min) normal operation rate (20% suction control)
- Greater than or equal to 30 CFM boost evacuation (100% suction control)
- <35 lb unpacked weight

ULPA filter module

- VLSI grade
- Traps particles greater than or equal to 0.12 µm
- Three-stage filtration (pre-filter, ULPA, post-filter)
- Particulate removal efficiency >99.9995%

Air filter

- Filter medium is an open-cell polyurethane foam
- Medium specially coated for improved fire retardation and fungi resistance
- High dust-trapping capacity, low air resistance

- Can be used in a wide variety of climatic conditions
- Rated UL 94 HF-1

11

Biosafety Cabinet Option

The following topics are covered in this chapter:

- [Biosafety cabinet overview \(page 206\)](#)
- [Aerosol Management System \(page 210\)](#)
- [Operating the AMS \(page 211\)](#)
- [Working in the BSC \(page 213\)](#)
- [Cleaning the base pan \(page 214\)](#)
- [Replacing the electronics cable plastic sleeve \(page 216\)](#)

Biosafety cabinet overview

The optional biosafety cabinet (BSC) is designed to be used with the BD FACSymphony™ S6 cell sorter, with the sorting hardware located inside the BSC. Biosafety protection is provided by negative pressure and controlled air flow within the cabinet. Before entering the work area or leaving the top of the cabinet, air passes through high-efficiency particulate air (HEPA) filters. An integrated Aerosol Management System (AMS) operates independently from the BSC blower and provides additional biosafety protection. The AMS evacuates the sort chamber during sorting and exhausts that air through a separate HEPA filter. Air flow probes in the BSC and AMS monitor exhaust air flow. An audible alarm is triggered if the air pressure differential (BSC) or air flow (AMS) drops to an unsafe level.

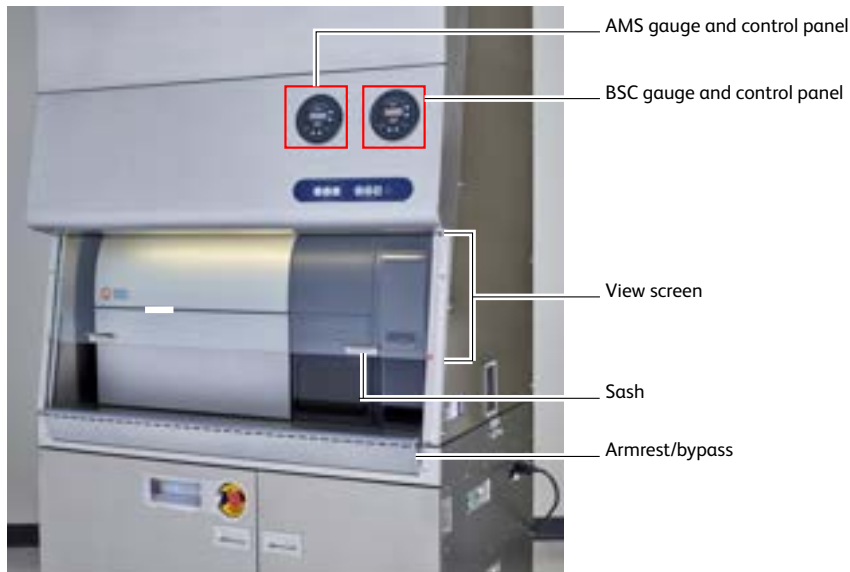

Operating the BD FACSymphony™ S6 cell sorter inside the BSC can generate temperatures above the acceptable range of 17.5–22.5 °C (63.5–72.5 °F). Monitor the temperature inside the BSC to ensure that it does not exceed this range.

An optional FlexAIR® canopy can be purchased to connect the BSC to an in-house exhaust system. The FlexAIR canopy can help alleviate excess heat inside the BSC. Lowering the temperature inside the lab will also help keep the temperature down.

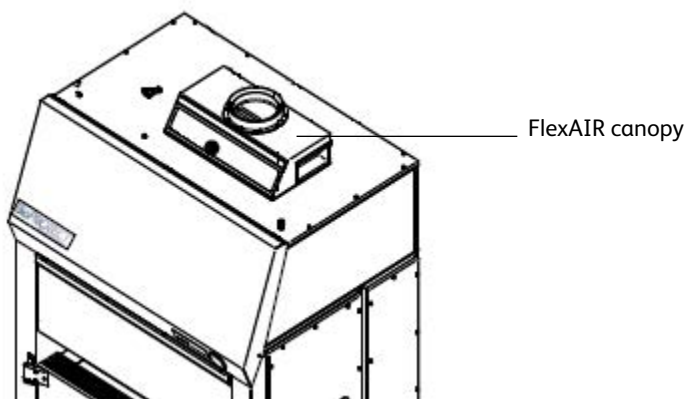

For safety information about the BSC, see the *BD FACSymphony™ S6 cell sorter Safety and Limitations Guide*. Additional BSC information not contained in this guide can be found in The Baker Company *Biosafety Cabinet for BD FACSymphony™ S6 cell sorter Operator's Manual*.

View screen

The view screen is made from safety plate glass and is the barrier between the BSC work area and the user.

- Maximum opening: The view screen can be opened to a maximum of 18 inches to allow temporary full access to the work area.
- Minimum opening: The view screen can be fully closed.

Sash

The sash is the bottom edge of the view screen. Grip the sash and slowly:

- Pull down to close the view screen
- Push up to open the view screen

Safe Work access opening



The safe work access opening is 8 inches, which provides biosafety protection. If the sash is raised above 8 inches for more than 3 seconds, an alarm sounds.

The safe work access opening is marked by a red arrow located on both sides of the BSC frame. Ensure that the sash is at this level each time you work in the BSC.

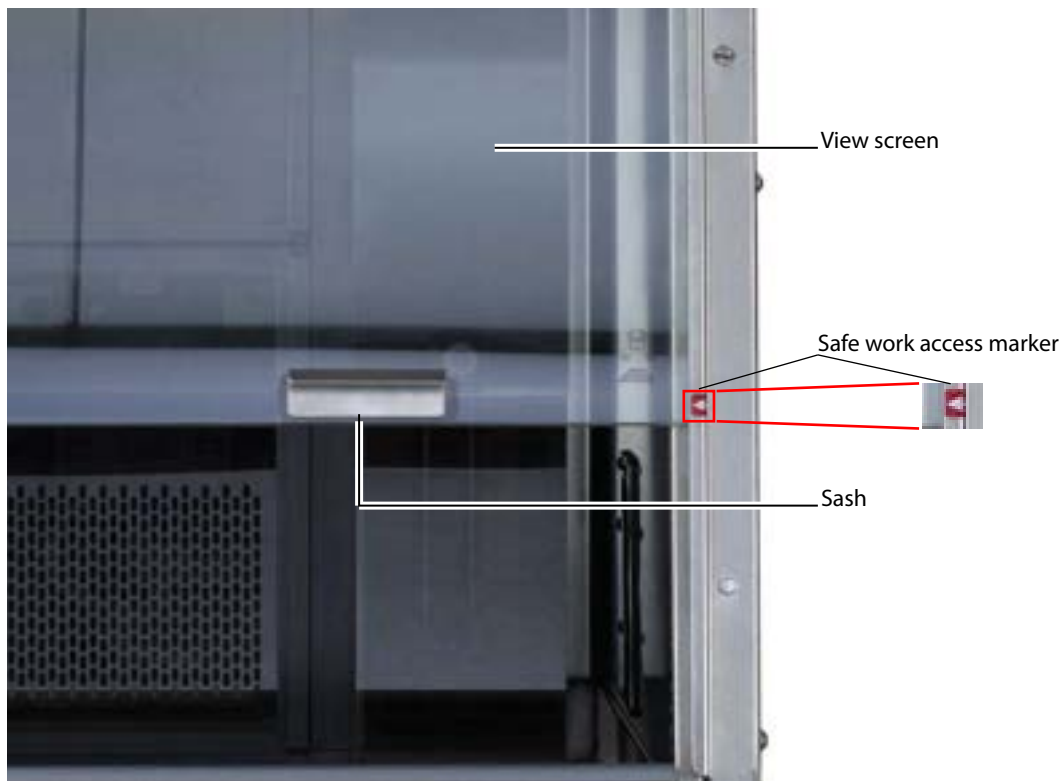

Ready safe mode

The ready safe mode is an energy saving mode for when the BSC is not in use. To put the BSC in ready safe mode:

- Keep the blower on.
- Lower the sash to fully close the view screen.
- Check the differential pressure gauge to verify that the pressure decreases. (See [View screen \(page 207\)](#) for more information.)

We recommend that you leave the BSC in ready safe mode when it is not being used.

Cabinet gauge and controls

The BSC differential pressure gauge and cabinet controls are located on the front of the BSC in the lower right corner. (The BSC and AMS controls are located on the same panel.) The BSC controls are on the right side of the panel.

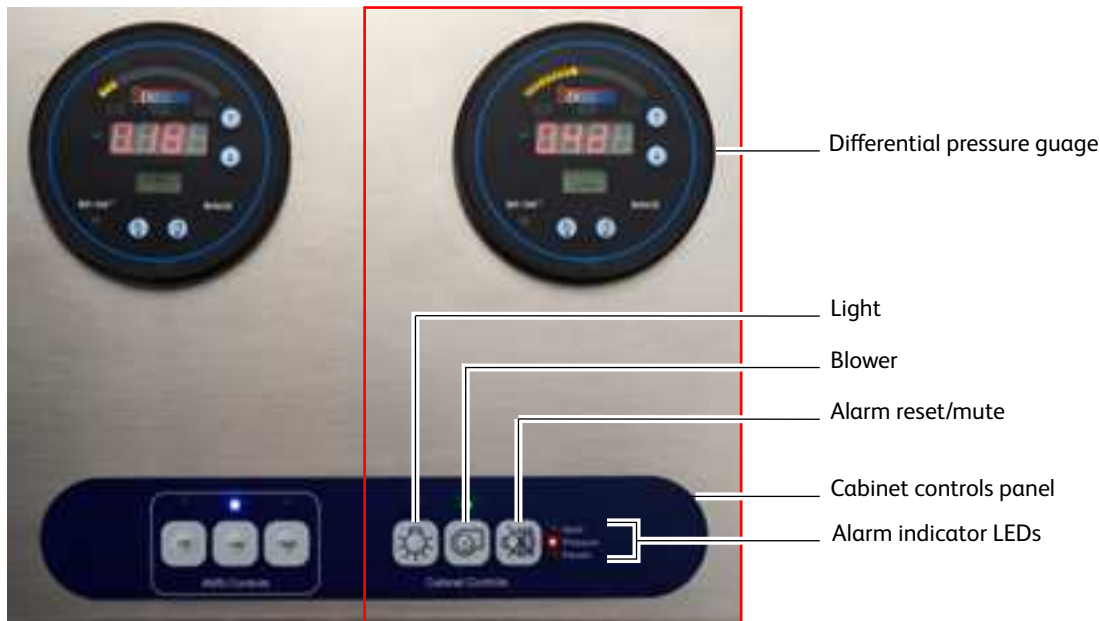

Differential pressure gauge

The differential pressure gauge displays the difference in air pressure inside the BSC vs outside the BSC, measured in inch water column (inch WC). The reading should be the value obtained during certification $\pm 20\%$. (See your BSC certification paperwork.) If the value drops below this level, the pressure alarm will sound and an orange indicator LED will flash. See [Buttons and LED indicators \(page 208\)](#).

Buttons and LED indicators

The following table describes the function of the BSC control buttons and the meaning of the LED indicators located above each button.

Button	Function	LED indicates	LED color	Comments
Light	Turns the light on and off	Power is on	Blue	Two fluorescent lamps light the work area.
Blower	Turns the blower on and off	Power is on	Green	The blower creates the air flow patterns inside the BSC.
		Power is off	Flashing green	–
Alarm	Mutes the alarm for 5 minutes or resets it	See LED alarm indicators (page 209) .		

LED alarm indicators

LED indicators to the right of the Alarm button are illuminated when there is an alarm condition. The following table describes the LEDs and conditions that trigger them.

Alarm	LED Color	Condition
Sash	Flashing red	<ul style="list-style-type: none"> The sash is raised above the 8-inch safe opening height. The sash is lowered to fully close the view screen (until pressure decreases).
Pressure	Flashing orange	<ul style="list-style-type: none"> The air pressure differential drops to an unsafe exhaust airflow level. The air pressure differential has not reached the proper level. (This occurs when the blower is first turned on.)
	Solid orange	The air pressure problem was corrected. Press the alarm button to reset the alarm.
FlexAIR ^a (if installed)	Flashing yellow	The air flow through the canopy drops to an unsafe level.

Audible alarms

An LED indicator to the right of the alarm button is illuminated when there is an alarm condition. Audible alarms differ for each alarm type. The following table describes the alarms and conditions that trigger them.

LED Indicator	Audible Alarm	Condition
Sash	Sounds once per second.	The sash is positioned at an unsafe level for more than 3 seconds.
Pressure	Sounds four times per second followed by a two-second delay.	<ul style="list-style-type: none"> The air pressure differential drops to an unsafe exhaust air flow level. The air pressure differential has not reached the proper level. (This occurs when the blower is first turned on.)
FlexAIR ^b (if installed)	Sounds two times per second.	The air flow through the canopy drops to an unsafe level.

^aThe optional FlexAIR canopy can be purchased to connect the BSC to an in-house exhaust system.

^bThe optional FlexAIR canopy can be purchased to connect the BSC to an in-house exhaust system.

For detailed instructions on how to use the BSC, what the alarm conditions indicate, and how to reset them, see The Baker Company *Biosafety Cabinet for BD FACSymphony™ S6 cell sorter Operator's Manual*.

Aerosol Management System

An AMS is incorporated into the BSC to rapidly evacuate aerosolized particles from the sort collection chamber during sorting or analysis. Equipped with a separate HEPA filter, the AMS operates independently of the BSC. The AMS will continue to operate if the BSC blower fails, providing an additional level of biosafety protection.

AMS gauge and controls

The AMS air flow gauge and controls are located on the front of the BSC in the lower right corner, to the left of the BSC controls.

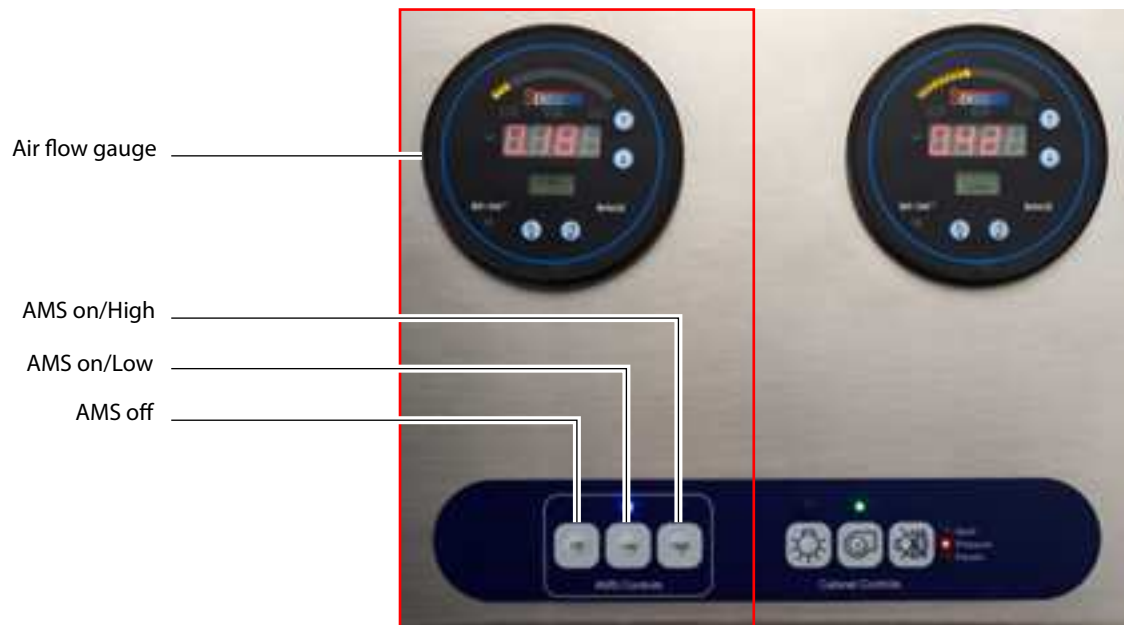

Air flow gauge

The air flow gauge indicates the amount of suction being applied to evacuate the sort collection chamber and the aspirator drawer. The air flow is measured in CFM.

The air flow value should be:

- Low: 14 CFM \pm 1 CFM
- High: >26 CFM

See [Buttons and LED indicators \(page 210\)](#) and [Audible alarms \(page 211\)](#).

Buttons and LED indicators

The following table describes the functions of the AMS control buttons and the meaning of the LED indicators located above each button.

Button	Function	LED Color	Comments
AMS off	Turns the AMS off	Blue	Turn the AMS off when it is not in use.
AMS on/Low	Turns the AMS and low suction on. Turns low suction off.	Blue	Use low suction during normal sorting.
AMS on/High	Turns the AMS and high suction on. Turns high suction off.	Blue	Use high suction while removing a clog.

Audible alarms

An LED indicator will flash above the corresponding button when there is an alarm condition. The following table describes the meaning of the LED indicators and the alarms and conditions that trigger them.

LED Indicator	LED Color	Audible Alarm?	Condition
AMS on/Low	Flashing orange	Yes	The air flow is outside the range of 14 ± 1 CFM. (This also occurs when the AMS is first turned on.)
AMS on/High	Flashing orange	Yes	The air flow is <26 CFM. (This also occurs when the AMS is first turned on.)

Operating the AMS



The AMS does not eliminate the health risks of working with biohazardous material and must be used in conjunction with good laboratory practice.

- To turn on the AMS, press either the Low or the High button.
 - A blue indicator LED is illuminated over the button.
 - The air flow gauge goes through a startup sequence and then equilibrates.
- Operate the AMS in:
 - Low during normal sorting.
 - High while removing a clog. See [Responding to a nozzle clog during a sort \(page 211\)](#) to troubleshoot a nozzle clog.
- Press the AMS Off button to turn off the AMS.
 - A blue indicator LED is illuminated over the AMS off button.
 - The flow air gauge shuts off.

Responding to a nozzle clog during a sort

If the stream is disturbed during the sort (due in part to a clogged nozzle), the sort is designed to stop automatically and block the sort tubes (if the Sweet Spot is on). The sort will not restart until the operator has cleared the clog. In the event of a nozzle clog, do not open the sort collection chamber door or access the sort tubes before following this procedure.



Cell sorters that use droplet generation methods, such as the BD FACSymphony™ S6 cell sorter, can produce aerosols around the sample stream. When acquiring biohazardous samples, follow universal precautions at all times. Keep the sort block door and the sort collection chamber door closed during sorting. Follow these steps to stop sample flow and evacuate potential aerosols before opening the sort collection chamber door.

To clear a clogged nozzle on a system with the AMS:

1. Keep the sort chamber door closed.
2. If the stream has not already shut down automatically, turn off the stream by clicking the **Stream** button (with a checkmark) at the top of the **Breakoff** window.
This will shut off the stream, unload the sample, and close the aspirator drawer.
3. Increase the air evacuation rate to high.
4. Open the aspirator drawer using the software controls.
5. Wait at least 60 seconds.
This procedure will clear aerosols from the sort chamber.
6. Close the aspirator drawer.
7. Turn on the stream and view the breakoff.
If the clog is removed, the breakoff will be similar to the breakoff before the clog.
8. If the clog is not cleared, turn the stream on and off several times to see if the clog has cleared.
9. If the clog is not removed, turn the stream off and perform the Clean Flow Cell procedure with DI water (see [Cleaning the flow cell \(daily\) \(page 140\)](#)), followed by turning the stream on to see if the clog has cleared.
10. Open the aspirator drawer and evacuate for at least 60 seconds before closing the aspirator drawer again.
11. You can now open the sort collection chamber and remove the sort collection device. Be aware that the surfaces of the device are potentially contaminated.



All cytometer surfaces that come in contact with biological specimens can transmit potentially fatal disease. Use universal precautions when cleaning cytometer surfaces. Wear suitable protective clothing, eyewear, and gloves.

12. If it is necessary to change nozzles or remove a clog from a nozzle, see [Cleaning the integrated nozzle \(page 156\)](#).
13. With stream turned off, open the sort block door and dry the plates and surfaces as needed.
14. When removing collection tubes, be aware that the outside of the tube is potentially contaminated. Use alcohol swabs or bleach to wipe the outsides of tubes.
15. Press the AMS Low button.
16. Make sure that all chamber doors are closed and restart the stream.
17. Perform these tasks if needed:
 - Turn on the Sweet Spot
 - Check the drop delay
 - Check the side stream deflection

Working in the BSC

When working inside the BSC, we recommend that you:

- Keep the blower on at all times.
- Keep the AMS on while sorting.
- Keep the view screen closed to the safe-access opening of 8 inches each time you work in the BSC.
- Do not work in the BSC if an alarm sounds and the corresponding indicator is illuminated. See the The Baker Company *Biosafety Cabinet for BD FACSymphony™ S6 cell sorter Operator's Manual* for troubleshooting information. If additional assistance is required, contact your local BD Biosciences technical support representative or supplier.
- Do not block the intake grilles or the diffusers because it obstructs air flow.

Note: Consult a qualified safety professional for decontamination procedures appropriate for you laboratory.

- Decontaminate the BSC and cytometer before:
 - Turning off the blower.
 - Having maintenance or service performed.
- Keep the blower on at all times and keep the view screen closed when the BSC is not being used, especially if you want the inside of the BSC to remain contamination-free.
- Use an adjustable chair for comfort.

Cleaning the BSC

Use this procedure to clean the BSC after sorting potentially infectious agents.

Materials

- 10% chlorine bleach (0.5% sodium hypochlorite) solution



Bleach can cause stainless steel to pit and crack. Ensure that you wipe down the BSC with 70% isopropyl alcohol to remove the bleach solution.

- 70% isopropyl alcohol
- Paper towels

Procedure



Any surface that comes in contact with biological specimens can transmit potentially fatal disease. Use universal precautions when cleaning the BSC. Wear suitable protective clothing, eyewear, and gloves.

To clean the BSC:

1. Wipe down the following areas using paper towels and 10% bleach (0.5% sodium hypochlorite) solution:
 - Floor of the BSC in front of the cytometer, and on each side
 - Inside and outside surfaces of the view screen
 - Armrest/bypass
 - Cabinet Controls panel
 - Any other areas that might be contaminated
2. Repeat step 1 using 70% isopropyl alcohol.

Cleaning the base pan

Note: Before cleaning the base pan, clean the inside of the BSC. See [Cleaning the BSC \(page 213\)](#).

Use the following procedure to clean the base pan.

Materials

- 10% chlorine bleach (0.5% sodium hypochlorite)



Bleach can cause stainless steel to pit and crack. Ensure that you wipe down the BSC with 70% isopropyl alcohol to remove the bleach solution.

- 70% isopropyl alcohol
- Paper towels
- A cleaning tool to reach into the base pan

Procedure



Any surface that comes in contact with biological specimens can transmit potentially fatal disease. Use universal precautions when cleaning the base pan. Wear suitable protective clothing, eyewear, and gloves.

To clean the BSC:

1. Press in on the armrest/bypass and lift it up.



2. Remove the armrest/bypass.
3. Wipe down the armrest/bypass using paper towels and 10% bleach (0.5% sodium hypochlorite) solution.
4. Wipe down the armrest/bypass using paper towels and 70% isopropyl alcohol.
5. Set the armrest/bypass aside.
6. Wipe down the base pan using a cleaning tool and a 10% bleach (0.5% sodium hypochlorite) solution. Ensure that you also wipe down the areas underneath the electronic cables.

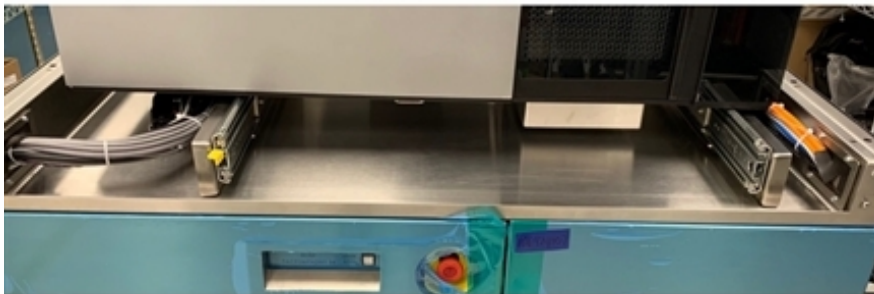

7. Wipe down the base pan using a cleaning tool and 70% isopropyl alcohol.
8. Check the position of the tabs above the base pan on either side of the BSC.

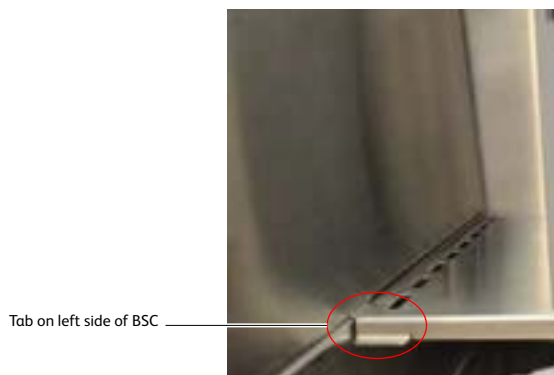

9. Reinstall the armrest/bypass by sliding it into position over the tabs.



10. Lock the armrest/bypass into place by pushing it down and back so that the bottom snaps into place behind the lip of the base pan.

Replacing the electronics cable plastic sleeve

Some of the electronics cables for the BD FACSymphony™ S6 cell sorter are located under the cytometer in the base pan. The cables are wrapped in plastic sleeves to protect the cables from exposure to liquids. When cleaning the base pan, check the plastic sleeves and replace them as necessary. Replacements are located in the spares kit.

To replace the plastic sleeves:

1. Remove the armrest/bypass by following step 1 through step 5 in [Cleaning the base pan \(page 214\)](#).
2. Check the plastic sleeves covering the electronic cables in the left and right sides of the base pan.

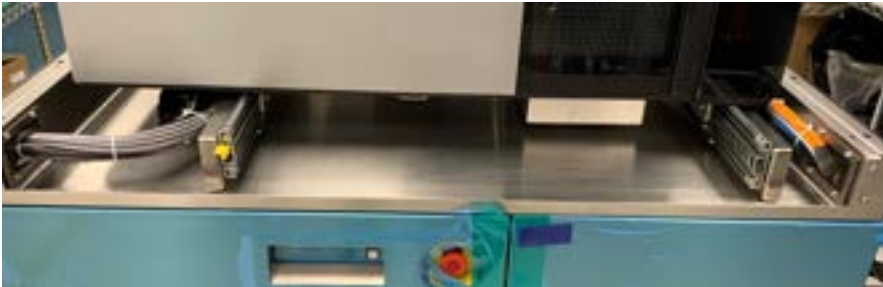

3. If necessary, remove the plastic sleeves by carefully removing the ties at each end of the sleeve and peeling off the plastic sleeve.
4. Wrap the cable bundles with new plastic sleeves and secure with ties at each end.

12

BD FACSymphony™ S6 Temperature Control Option

The BD FACSymphony™ S6 Temperature Control Option can be used to control the temperature of sorted samples in the BD FACSymphony™ S6 cell sorter flow cytometer.

The following topics are described:

- [Option components \(page 218\)](#)
- [Using the BD FACSymphony™ S6 Temperature Control Option \(page 219\)](#)
- [Maintenance \(page 222\)](#)
- [Specifications \(page 223\)](#)

Option components

The BD FACSymphony™ S6 Temperature Control Option includes the following:

- A recirculating water bath
- Specially designed collection tube holders with ports for recirculating water

Tube holders are available in these styles: two-way 15-mL, four-way 12 × 75-mm, four-way 1.5-mL Eppendorf, and six-way 12 × 75-mm tubes.



Water bath

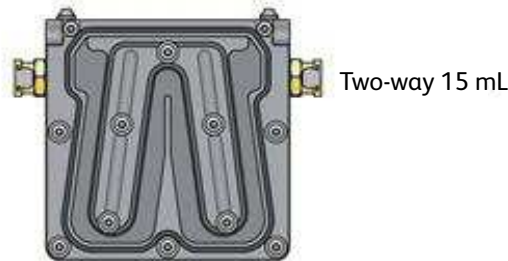

Two-way 15 mL



Four-way 12 × 75 mm

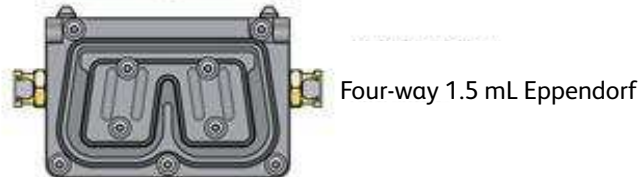

Four-way 1.5 mL Eppendorf



Six-way 12 × 75 mm



When acquiring biohazardous samples, follow universal precautions at all times. Keep the sort block door and the sort collection chamber door closed during sorting. When sorting biohazardous samples into the temperature control tube holders, we recommend that you use the BD[®] Aerosol Management Option (for systems without a BSC) or the BD[®] Aerosol Management System (for systems with a BSC). If the nozzle develops a clog, see [Responding to a nozzle clog during a sort with the AMO \(page 195\)](#) or [Responding to a nozzle clog during a sort \(page 211\)](#) (for systems with the AMS).

The BD FACSymphony™ S6 Temperature Control Option is for research use only. It is not for use in diagnostic or therapeutic procedures.

Using the BD FACSymphony™ S6 Temperature Control Option

Note: Before you start the recirculating water bath, you must attach the tubing to the appropriate collection device.

Setting up the water bath

1. Remove the threaded plug from the output port on the water bath.
2. Ensure that the drain cock on the back of the water bath is closed by turning it fully clockwise.
3. Set the pump outflow to maximum by turning the knob fully counter-clockwise.
Remove the top cover to access the knob, which is located inside the water bath toward the back. See the operating instructions supplied with the water bath for additional details on this process. This is referred to as position 1.
4. Connect the clear tubing end of the insulated hoses to the input and output ports on the water bath.
Slide the tubing over the hose barbs and twist gently while installing to get the tubing completely over the barbs.



5. Connect the insulated hoses from the recirculating water bath to the ports on the right side of the cytometer base.

Note: Because the water flow direction is controlled by the water bath pump, the ports on the cytometer base are multi-directional. The input and output hoses from the water bath can be connected to either port on the cytometer base.



6. Fill the water bath with distilled water containing 0.1 g/L of sodium carbonate.
Sodium carbonate helps reduce corrosion. See the water bath manufacturer's documentation for fill levels and other setup information.
Note: We do not recommend using ethylene glycol (antifreeze) in the water bath.
7. Plug in the water bath power cord.

Do not start up the water bath until after you have connected the recirculating water tubing, as described in the following sections.

Setting up the tube holder

This section describes how to install the temperature control tube holder on the instrument and how to attach the recirculating water tubing to the tube holder.



Any instrument surface that comes in contact with biological specimens can transmit potentially fatal disease. Use universal precautions when handling sorting hardware. Wear suitable protective clothing and gloves.

1. Place collection tubes in the temperature control tube holder.
2. Attach the recirculating water tubing to the tube holder.

- a. Open the sort collection chamber door.

NOTE The tubing ports are labeled *In* and *Out*. Attach the input tubing to the port on the left side of the collection tube holder, and the output tubing to the port on the right side.

- b. To attach the tubing, push it into the port until the tubing snaps into place.

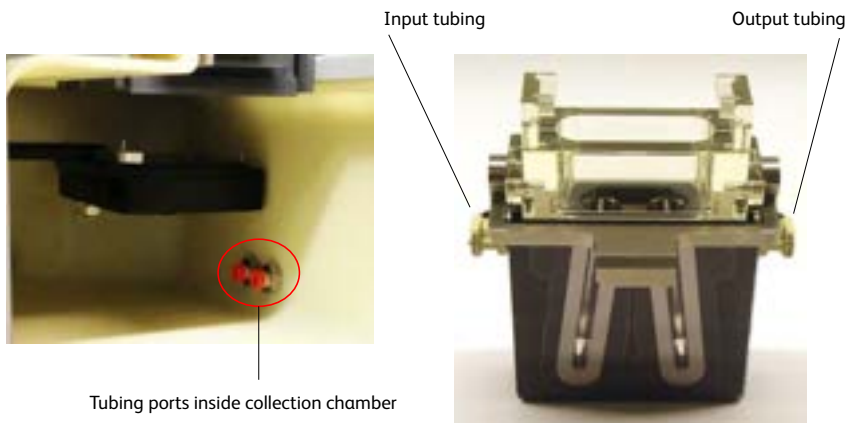

If you need to remove the tubing, push in the orange collar as you pull the tubing out of the port.

3. Install the tube holder on the instrument.
4. Install the temperature control tube holder.
5. Close the sort collection chamber door and start up the water bath.

Setting up the ACDU stage

This section describes how to attach the recirculating water tubing to the stage used with the automated cell deposition unit (ACDU).



Any instrument surface that comes in contact with biological specimens can transmit potentially fatal disease. Use universal precautions when handling sorting hardware. Wear suitable protective clothing, eyewear, and gloves.

1. Install the splash shield below the aspirator drawer.
 - a. Close the sort block door and open the sort collection chamber door, if needed. (The sort block door must be closed to open the collection chamber door.)
 - b. Remove the tube holder, if one is installed.

- c. Insert the splash shield into the slotted fittings below the sort aspirator drawer. Push the splash shield all the way in.
2. Click the **Access Stage** button to bring the ACDU stage to the front.
 - a. Open an experiment, if one is not already open, and create a sort layout for any of the tubes.
 - b. In the **Sort Layout** view, click the **Access Stage** button to move the stage to the front of the sort collection chamber.
3. Attach the recirculating water tubing to the ACDU stage.

Note: The tubing ports are labeled *In* and *Out*. Attach the input tubing to the port on the left side of the stage, and the output tubing to the port on the right side.

To attach the tubing, push it into the port until the tubing snaps into place.

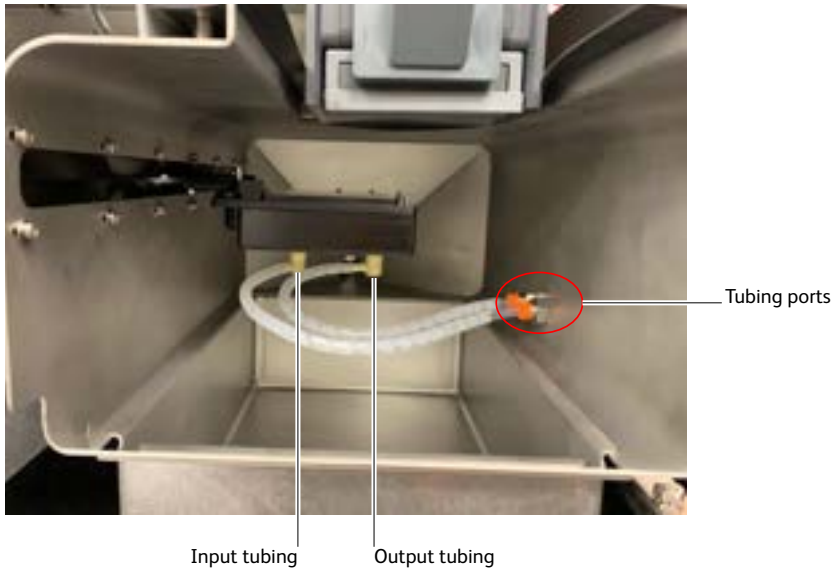

- If you need to remove the tubing, push in the orange collar as you pull the tubing out of the port.
4. Install the appropriate collection device on the stage.
 5. Close the sort collection chamber door and start up the water bath.

Starting up the water bath

Note: To ensure that the sample collection device is at the correct temperature, start up the water bath (115-V and 110-V models) at least 90 minutes before you start sorting.

1. Switch on the main power on the water bath control panel.



- Use the up or down arrow keys to set the required temperature.

Note: To achieve the required sample temperature, you will need to set the water bath temperature slightly higher or lower as shown in the following table. These settings might need adjustment depending on the ambient temperature in your laboratory. We recommend that you calibrate the water bath for your operating environment.

Required Sample Temp (°C)	Water Bath Setting (°C) at Room Temperature of 15 °C	Water Bath Setting (°C) at Room Temperature of 30 °C
4	2	2
37	43	41
42	52	45

- Wait at least 90 minutes to allow the recirculating water to reach the required temperature. The duration may be longer if switching over a large temperature range or when attempting to cool the sample.

Maintenance

To maintain the recirculating water bath, see the documentation provided by the manufacturer.

Tube holders

Remove the tube holders when you are finished using them, and clean them periodically before storage.



When you detach the recirculating water tubing from the tube holder, any fluid remaining in the tubing can leak into the sort collection chamber. To ensure that fluid is aspirated from the sort collection chamber, make sure that the sort chamber aspirator pump is on (do not turn off the instrument main power) before you detach the tubing. Use caution when handling tubing containing hot water.

To detach the recirculating water tubing, push in the orange collar as you pull the tubing out of the port.

Clean the temperature control tube holders by wiping them down with an appropriate cleaning fluid (for example, 70% ethanol, 5% bleach, or DI water). Dry them with a lint-free cloth before storage.

Recirculating water tubing

Inspect the tubing periodically for leaks, plugs, or contaminants. If needed, remove the tubing and clean it with an appropriate cleaning solution, or replace the tubing. Contact your BD Biosciences service representative for replacement tubing.

Specifications

Specifications for the recirculating water bath are as follows.

Note: The following specifications are for the US version only.

The BD FACSymphony™ S6 Temperature Control Option includes the Lauda® Ecoline cooling/heating bath, model RE 106.

- Operating temperature range: –20–+20 °C
- Ambient temperature range: 5–40 °C
- Heater power for 115 V/60 Hz: 1.3 kW
- Maximum flow rate at pump output of 5: 17 L/min
- Maximum bath volume: 4–6 L
- Power consumption for 115 V/60 Hz: 1.4 kW

For more information, see the manufacturer's documentation.

This page intentionally left blank

4

4-Way Purity mode 53

A

aborts

 electronic 180

 See also conflicts, sort[aborts

 aaa] 74

Access Stage button 75

accessory kit, contents 184

Accudrop

 about 49

 experiment 85, 123

 optimizing drop delay 124

ACDU 25

acquisition

 controls 68

 events to record 112

Acquisition Dashboard 68

adding

 cytometer configurations 61

 folders 108

 sort layouts 73, 127

 sort populations 73, 128

adjusting

 amplitude 46, 92

 area scaling 104, 106

 Drop 1 46, 93

 drop delay 124

 flow rate 35, 68

 Home location 133

 laser delay 116

 micrometer dial 125-126

 PMT voltages 41

 side streams 133

 sort block angle 20, 156

 Window Extension 117

aerosol management option (AMO)

 about 22

 changing filters 154

 components 192

 maintenance 196

 specifications 203

 starting up the evacuator 193

 troubleshooting 201

 ULPA filter 192

 using 191, 203

agitating samples 57

air

 external 31

 filters, changing 154

 line 90

 pressure 29

 supply, external 31

air flow gauge

 AMS 210

alarms

 AMS 211

 BSC 209

AMO See aerosol management option 22

amplitude

 about 45

 adjusting 46, 92

AMS

 air flow gauge 210

 alarms 211

 buttons 210

 LED indicators 210

analysis

 batch 115

 data 111

 printing 114

 sorting 114, 120, 127

- application settings
 - about 103
 - adjusting area scaling 104
 - creating 104
 - optimizing PMT voltages 107
 - saving 108
 - window 109
- applications
 - custom 61
 - recommended flow rates 36
 - recommended sort setup 70
- area parameters 40
- arrays, detector 27, 37
- aseptic sorting 146
- aspirator digital reference lines 48
- aspirator drawer
 - about 21
 - opening 48, 75, 129
- assistance, technical 9
- attenuation control 48
- auto drop delay
 - about 49
 - graph 127
 - overview 126
 - using 126
- autoclaving sheath tank 146
- automated cell deposition unit 25
- automated cell deposition unit (ACDU)
 - accessing stage 75
 - chamber 22
 - collection devices 134
 - custom devices 135
 - installing splash shield 132
 - sorting 132
 - troubleshooting 175

B

- backflush, sample line 145
- bandpass filters 38
- base configurations 64
- base pan
 - cleaning 214

- batch analysis, performing 115
- BD FACSDiva software See software 12
- BD FACSymphony S6
 - about 12
 - cytometer 13
 - workstation 12
- beads
 - Accudrop 124
 - calibration 188
 - CS&T research 101
 - setup 100
- beam splitters 38
- biexponential
 - display 112
 - sort gates 127
- bleeding filters 148
- breakoff
 - drop 43
 - setting up 92-93
 - troubleshooting 92, 173
 - window 45, 69
- BSC
 - alarms 209
 - cleaning 213
 - LED indicators 209
 - maintenance 213
 - ready safe mode 208
 - safe work access 207
 - sash 207
 - view screen 207
- bubble detector 17
- bulk sorting 120
- buttons
 - Access Stage 75
 - AMS 210
 - chamber light 17
 - emergency stop 31
 - Load 68
 - See also controls[buttons
 - aaa] 45
 - Sort 74
 - Unload 68

- waste drawer 48
- C**
- calculating compensation 110
 - cameras
 - about 28, 49
 - cleaning windows 163
 - cap, waste 99
 - chambers
 - ACDU 22
 - sample injection 17
 - sort block 20
 - sort collection 22
 - changing
 - air filters 154
 - fluid filters 148
 - nozzles 155
 - optical filters 167
 - pinch valve tubing 161
 - sample lines 149-150
 - waste cap 99
 - charging drops 49
 - cleaning
 - base pan 214
 - BSC 213
 - camera windows 163
 - cytometer 144
 - flow cell 140
 - fluidics 146
 - mode failure 181
 - modes 144
 - nozzles 156
 - optical filters 168
 - strobe lens 164
 - clogged nozzle
 - cleaning 156
 - responding to during a sort 130
 - responding to during a sort with AMO 195
 - responding to during a sort with AMS 211
 - closed-loop nozzle
 - cleaning 158
 - for shutdown 140
 - installing 143
 - maintenance 158
 - replacing tubing 159
 - coefficient of variation (CV), high 179
 - collection
 - devices 22, 72
 - optics 26
 - tubes, replacing 130
 - compensation
 - calculating 110
 - controls, creating 109
 - gating data 111
 - setup 111
 - components
 - AMS 211
 - BD FACSDiva workspace 56, 69
 - BSC 13
 - cytometer 13
 - electronics 29
 - fluidics 16
 - optics 25
 - workstation 12
 - computer
 - about 12
 - shutting down 140, 143
 - configuration, cytometer
 - about 40, 59
 - adding 61
 - and sort setup 67
 - copying 64
 - custom 62
 - editing 65
 - mismatch dialog 103
 - selecting 101
 - conflicts, sort
 - about 50
 - counting 75
 - printing 75
 - saving 74, 128
 - troubleshooting 176
 - connecting
 - external air 31

containers

- about 15
- autoclaving 146
- emptying waste 97
- refilling 96

controls

- ACDU stage 75
- acquisition 68
- aspirator drawer 48, 75
- attenuation 48
- BSC 208
- compensation 109
- cytometer (software) 56
- flow rate 68
- fluidics 56
- optical filter 48-49
- See also buttons[controls
 - aaa] 75
- sorting 69, 74
- stream 45
- Sweet Spot 45
- test sort 48
- tube loading 68
- voltage 48
- waste drawer 48

conventions, user's guide 8

cooling samples 58, 89

cord, fluidics cart 29

counters, sorting 75

creating

- analysis objects 114
- application settings 104
- compensation controls 109
- custom devices 70, 135
- folders 108
- sort layouts 73, 127
- sort precision modes 53
- statistics view 114

CS&T See Cytometer Setup and Tracking 59

custom devices 70, 135

custom optical filters 167

customer support 9

cuvette flow cell

- about 19
- cleaning 140

cytometer

- about 13
- adding configurations 61
- cleaning 144
- configuration 40, 59, 100
- controls, software 56
- disconnect error 182
- electronics 29
- fluidics 16, 34
- not responding 182
- optics 25
- performance 99
- power 88
- QC particles 188
- shutting down 140, 142
- starting 88
- status report 60
- supplies 184
- workstation 12

Cytometer Setup and Tracking (CS&T)

- menu selections 59
- overview 99
- research beads 101

D

daily shutdown procedure 140

Dashboard, Acquisition 68

data

- analyzing 111, 114
- gating 111, 114
- recording 111, 113

data collection, overview 108

deflection

- drop 50
- plates 20, 121

removing 165

troubleshooting 175

delay
 drop 48-49, 123
 See also Accudrop 123
 laser 42, 116
 deleting
 custom devices 136
 sort populations 74
 sort precision modes 54
 detectors 40
 devices, sorting 72, 135-136
 diode laser 49
 discriminating filters 39
 doors, sort collection chamber 25
 doublets
 discrimination experiment 85
 discrimination gating 109
 eliminating 113
 drawer See aspirator drawer 21
 drop
 auto delay 126
 breakoff 43
 charging 49
 conflicts 50
 correction factors 48, 121
 deflection 50
 delay 48-49, 123-124
 See also Accudrop 123
 drive frequency 45
 formation 43
 satellites 93
 Drop 1
 about 45
 adjusting 46, 93

E

editing
 cytometer configurations 65
 sort layouts 74
 statistics view 114
 electronics
 aborts 180

 about 29
 signal processing 40
 emergency stop button 31
 emission
 spectra 36
 emptying waste 97
 error messages
 cleaning mode failure 181
 cytometer disconnected 182
 cytometer not responding 182
 Master DAQ overflow 182
 ethanol shutdown
 tank
 capacity 94
 refilling 95
 events
 not showing in plots 177-178
 rate, troubleshooting 178-179
 target 73, 128
 troubleshooting 180
 excitation optics 26
 Experiment Layout 112
 experiments
 Accudrop 85, 123
 cytometer QC 85
 doublet discrimination 85
 setting up 112
 sorting 127
 templates 85
 exporting sort reports 76, 129

F

FACSDiva software See software 12
 FACSymphony S6 See BD FACSymphony S6 12
 ferrules, removing 151, 153
 fiber optics 26
 filling containers 96
 filters
 about 38
 air, changing 154
 bandpass 38

- changing 148, 167
- discriminating 39
- fluid, changing 148
- longpass 38
- neutral density (ND) 39, 168
- optical 38, 168
- purging 148
- removing 148, 168
- sample line 159
- Fine Tune mode 53
- flow cell
 - about 19
 - access door 128
 - cleaning 140
- flow rate
 - about 36
 - adjusting 35, 68
 - recommendations 36
- fluid
 - containers 15
 - filters 148
 - level indicators 58
 - line 90
 - movement 34
 - priming 97, 145
 - refilling 96
- fluidics
 - about 34
 - cleaning 146
 - components 16
 - containers 15
 - controls 56
 - daily shutdown 140
 - level indicators 58
 - power 29
 - shutdown 57, 142
 - startup 34, 56, 90
 - system 34
- fluidics cart
 - cord 91
 - power 29
- fluorescence
 - about 36
 - emission spectra 36
 - signal, troubleshooting 178
- folders, adding 108
- forward scatter (FSC)
 - about 36
 - detector 40
 - ND filter 168
 - removing 168
- frequency, drop drive 45
- G**
- Gap 45
- gating
 - compensation controls 111
 - data 114
 - during sorting 127
- global worksheets
 - adding sort layouts 73, 127
 - previewing data 111
 - setting up 112
- H**
- hardware, ACDU 132
- hazard symbols 8
- hazards, mechanical 31
- heating samples 58, 89
- height parameters 40
- holders
 - collection tube 22, 121, 220
 - sample tube 18
- Home Device 70, 133-134
- hydrodynamic focusing 35
- I**
- index sorting
 - description 136
 - setting up for 136
- Initial mode 53

installing
 collection tube holders 121, 220
 nozzle 155
 plates 132, 221
 sample line filter 159
 sample tubes 18
 slides 132, 221
 splash shield 132

instrument See cytometer 13

integrated nozzle
 about 19
 changing 155
 cleaning 156
 replacing seal 158

interrogation point 19

L

label-specific tubes 109

labels, parameter 112

labware, parts list 190

lasers

about 26
 delay 42, 116
 diode 49
 shutting down 140, 143
 starting 88
 warmup time 88

layout See sort layouts 73

leaks, troubleshooting 181

LED indicators

AMS 210
 BSC 209

lens, strobe 164

levels

fluid 58
 sample 17

lever, nozzle 91, 156

light

injection chamber 17
 scatter signals 36
 voltage warning 20

limitations 9

Link & Save 111

Load button 68

loading tubes 18, 35

long clean 181

longpass filters 38

M

maintenance

AMO 196
 BSC 213
 scheduled 144
 temperature control option 222
 unscheduled 155

managing aerosols 21

AMO 193
 AMS 211

Masks

about 50
 default precision modes 52
 Phase 51
 Purity 51
 Yield 50

Master DAQ overflow error 182

micrometer dial 125-126

mirrors, dichroic 38

mismatch dialog

configuration 103

modes

defining 53
 deleting 54
 sort precision 50, 52

monitoring sorts 75, 129

N

ND filters 39, 168

neutral density filters 39, 168

nozzles

about 19
 changing 155
 cleaning 156
 integrated 19
 lever 91, 156

- O-ring 186
- responding to clogs 130
- responding to clogs with AMO 195
- responding to clogs with AMS 211
- See also closed-loop nozzle[nozzles

- aaa] 19

- sizes 70, 155

- spare 187

O

- O-ring

- nozzle 186

- sample injection chamber 166

- opening

- aspirator drawer 48, 75, 129

- sample injection chamber 18

- Optical Filter control 48-49

- optical filters

- about 38

- changing 167

- cleaning 168

- custom 167

- optics

- about 25

- collection 26

- excitation 26

- fiber 26

- stream-viewing 28

- optimizing

- cytometer settings 108

- drop delay 124

- PMT voltages 107

- streams 133

- ordering supplies 183

P

- parameters

- about 40

- adding 40, 59, 61

- labels 112

- measuring 41

- scatter, distorted 179

- parts, replacement 187

- pausing sorting 46, 74, 130

- performance

- check, running 102

- tracking 59

- phase

- field 48

- masks 51-52

- photodiodes 40

- photomultiplier tubes (PMTs)

- about 40

- applying voltages 41

- assigning 40, 59, 61

- optimizing for application settings 107

- pinch valve

- changing tubing 161

- plate voltage 48

- plates

- deflection 20, 121

- removing 165

- installing 132, 221

- sorting into 132

- plots

- excessive debris 179

- no events in 177

- unexpected events in 178

- populations

- sorting 49, 73, 127-128

- troubleshooting 175, 180

- power

- cytometer 88

- fluidics cart 29

- precision modes 50, 52

- See also sort precision modes 52

- preferences, user 114

- pressure

- air 29

- sample 35

- sheath 34, 57

- sort, default values 70

- troubleshooting 181

priming fluids 97, 145
 printing
 sort reports 76, 129
 worksheets 114
 pulse, electronic 40
 purging filters 148
 Purity
 Masks 51
 mode 53, 127

Q

quality control (QC)
 experiment 85
 particles 188

R

ready safe mode 208
 reagents, parts list 189
 recording
 data 111, 113
 during sorting 129
 refilling
 ethanol shutdown
 tank 95
 plastic containers 96
 sheath tank 94
 removing
 deflection plates 165
 ferrules 151, 153
 filters 148, 167-168
 sample line filter 159
 replacement parts 187
 replacing
 closed-loop nozzle tubing 159
 tubes 129
 reports
 cytometer status 60
 printing 76, 129
 sort 75
 results, troubleshooting 176
 rotating sort block 20, 156

running performance check 102

S

safety, general 31
 sample
 agitation 57
 core diameter 35
 flow 35
 injection chamber
 about 17
 lubricating O-ring 166
 interrogation 19
 line
 backflush 145
 changing 149-150
 filter 159
 pressure 35
 temperature 58, 89
 tubes, replacing 130
 samples
 heating 58, 89
 running 113
 sash
 BSC 207
 satellites, drop 93
 Save Conflicts 74, 128
 saving
 application settings 108
 sort conflicts 74, 128
 scatter
 light 36
 parameters, distorted 179
 second laser
 adjusting delay 116
 settings
 optimizing 108
 See also application settings[settings
 aaa] 108

- setup
 - beads 100
 - compensation 111
 - values, sort 70
- sheath
 - flow 34
 - pressure 34, 57
 - reservoir, autoclaving 146
- sheath filter
 - purging 148
- sheath probe
 - removing 145
- sheath tank
 - capacity 94
 - changing air filter 154
 - refilling 94
- shutdown tank, ethanol
 - capacity 94
 - refilling 95
- shutting down
 - computer 140, 143
 - daily procedure 140
 - fluidics 57, 140, 142
 - lasers 140, 143
- side scatter (SSC) 36
- side stream
 - select device 48
- side streams
 - optimizing 133
 - window 47, 69
- signals
 - about 36
 - detection 37
 - fluorescence 36
 - generating 40
 - low Area 178
 - no fluorescence 178
 - scattered light 36
 - troubleshooting 180
- Single Cell mode 53
- slides
 - installing 132, 221
- sorting into 132
- software
 - about 12
 - cleaning modes 144
 - components 56, 69
 - cytometer controls 56
 - templates 85
- sort
 - block 20
 - collection
 - chamber 22
- Sort button 74
- sort layouts
 - about 49
 - creating 73, 127
 - custom 70, 135
 - editing 74
 - entering populations 73, 128
- sort menu 69
- sort precision modes
 - 4-Way Purity 53, 127
 - about 50
 - creating 53, 69
 - defaults 52
 - deleting 54
 - Fine Tune 53
 - Initial 53
 - Purity 53
 - Single Cell 53
 - Yield 53
- sort reports
 - about 75
 - exporting 76, 129
 - printing 76, 129
- sort setup values 70
- sort, test 48
- sorting
 - about 43, 119
 - analysis 114, 120, 127
 - aseptic 146
 - aspirator drawer control 48, 75
 - bulk 120

- collection devices 72
 - conflicts 50, 74-75, 128, 176
 - controls 69, 74
 - counters 75
 - experiment 127
 - gates 127
 - index 136
 - into plates 132
 - into slides 132
 - into tubes 120
 - monitoring 75, 129
 - pausing 46, 74, 130
 - populations 49, 73, 127-128
 - recording data 129
 - resuming 129-130
 - setup 120
 - starting 74, 128
 - stopping 74
 - specifications
 - temperature control option 223
 - splash shield, installing 132
 - stage, accessing 75
 - starting
 - cytometer 88
 - fluidics 34, 56, 90
 - lasers 88
 - sorting 74, 128
 - stream 91
 - statistics view, creating 114
 - status, cytometer report 60
 - Stokes shift 36
 - stop button 31
 - stopping sorting 74
 - stream
 - centering 48, 121
 - control 45
 - deflecting 48
 - flow rate 34
 - setting up 133
 - starting 91
 - troubleshooting 91
 - viewing 28
 - strobe lens, cleaning 164-165
 - supplies, cytometer 184
 - Sweet Spot
 - about 43, 46
 - control 45
 - symbols, hazard 8
- ## T
- tanks See containers 96
 - target events 73, 128
 - technical assistance 9
 - temperature control option
 - maintenance 222
 - setting up ACDU 220
 - specifications 223
 - using 218, 223
 - water bath 219
 - temperature, sample 58
 - templates, experiment 85
 - Terasaki plate adapter 138
 - test sort 48, 134
 - threshold, troubleshooting 180
 - troubleshooting
 - ACDU 175
 - AMO 201
 - breakoff 92, 173
 - CVs 179
 - deflection 175
 - electronic aborts 180
 - event rate 178-179
 - leaks 181
 - low Area signal 178
 - populations 175, 180
 - pressure 181
 - scatter parameters 179
 - signals 178, 180
 - sorting 176
 - stream 91
 - threshold 180
 - tubes
 - adding sort layouts 73, 127
 - agitating 57

- compensation 109
- heating/cooling 58, 89
- holders 18, 22
- label-specific 109
- loading 18, 35
- replacing 130
- sorting into 22, 120
- unloading 18, 35
- typographical conventions 8

U

- ULPA filter on AMO 192
- Unload button 68
- unloading tubes 18, 35
- user preferences 114

V

- View Configurations selection 59
- view screen
 - BSC 207
- viewing global worksheets 112
- views
 - statistics 114
- violet laser
 - laser delay 42
- voltage
 - adjusting PMT 41
 - controls 48
 - optimizing PMT 107
 - warning light 20

W

- waste
 - aspirator 21
 - cap, changing 99
 - emptying 97
- water bath 219, 221
- width parameters 40
- Window Extension
 - adjusting 117
- windows
 - about 56, 69

- Acquisition Dashboard 68
- Breakoff 45
- camera, cleaning 163
- cytometer configuration 59
- device setup 134
- See also views[windows
 - aaa] 56
- Side Stream 47
- strobe lens 165
- worksheets
 - printing 114
 - See also global worksheets[worksheets
 - aaa] 112
 - viewing 112
- workspace
 - components 56, 69
 - setting up 108
- workstation
 - about 12
 - shutting down 140, 143

Y

- Yield
 - mask 50, 52
 - mode 53

Becton, Dickinson and Company
BD Biosciences
2350 Qume Drive
San Jose, California 95131 USA

BD Biosciences
European Customer Support
Tel +32.53.720.600
help.biosciences@bd.com

bdbiosciences.com
ResearchApplications@bd.com