

BD LSR II User's Guide

bdbiosciences.com
Part No. 642221 Rev A
June 2007



BD Biosciences
2350 Qume Drive
San Jose, CA 95131-1807
USA
Tel (877) 232-8995
Fax (800) 325-9637
facservice@bd.com

Asia Pacific
Tel (65) 6-861-0633
Fax (65) 6-860-1593

Europe
Tel (32) 2 400 98 95
Fax (32) 2 401 70 94
help.biosciences@europe.bd.com

Brazil
Tel (55) 11-5185-9995
Fax (55) 11-5185-9895

Japan
Nippon Becton Dickinson Company, Ltd.
Toll Free 0120-8555-90
Tel 81-24-593-5405
Fax 81-24-593-5761

Canada
Toll Free (888) 259-0187
Tel (905) 542-8028
Fax (888) 229-9918
canada@bd.com

Mexico
Toll Free 01-800-236-2543
Tel (52) 55 5999 8296
Fax (52) 55 5999 8288

© 2007, Becton, Dickinson and Company. All rights reserved. No part of this publication may be reproduced, transmitted, transcribed, stored in retrieval systems, or translated into any language or computer language, in any form or by any means: electronic, mechanical, magnetic, optical, chemical, manual, or otherwise, without prior written permission from BD Biosciences.

The information in this guide is subject to change without notice. BD Biosciences reserves the right to change its products and services at any time to incorporate the latest technological developments. Although this guide has been prepared with every precaution to ensure accuracy, BD Biosciences assumes no liability for any errors or omissions, nor for any damages resulting from the application or use of this information. BD Biosciences welcomes customer input on corrections and suggestions for improvement.

BD, BD logo and all other trademarks are property of Becton, Dickinson and Company. © 2007 BD

Texas Red™ and Pacific Blue™ are trademarks, and Cascade Blue® and Alexa Fluor® are registered trademarks of Molecular Probes, Inc. Sapphire and Radius are trademarks and Coherent is a registered trademark of COHERENT, INC. ALPHA is a trademark of Omega Optical, Inc. SPHERO is a trademark of Spherotech, Inc. Xcyte is a trademark of Lightwave Electronics. Microsoft and Windows are registered trademarks of Microsoft Corporation. Teflon is a registered trademark of E.I. du Pont de Nemours and Company. JDS Uniphase is a trademark of JDS Uniphase, Inc. ALPHA is a trademark of Omega Optical, Inc.

All other company and product names might be trademarks of the respective companies with which they are associated.

Patents

BD LSR II is covered by one or more of the following US patents and foreign equivalents: 4,745,285; 4,844,610; and 6,014,904.

PerCP: US 4,876,190

APC-Cy7: US 5,714,386

BD FACS lysing solution: US 4,654,312; 4,902,613; and 5, 098,849

FCC Information

WARNING: Changes or modifications to this unit not expressly approved by the party responsible for compliance could void the user's authority to operate the equipment.

NOTICE: This equipment has been tested and found to comply with the limits for a Class A digital device, pursuant to Part 15 of the FCC Rules. These limits are designed to provide reasonable protection against harmful interference when the equipment is operated in a commercial environment. This equipment generates, uses, and can radiate radio frequency energy and, if not installed and used in accordance with the instruction manual, may cause harmful interference to radio communications. Operation of this equipment in a residential area is likely to cause harmful interference in which case the user will be required to correct the interference at his or her own expense.

Shielded cables must be used with this unit to ensure compliance with the Class A FCC limits.

This Class A digital apparatus meets all requirements of the Canadian Interference-Causing Equipment Regulations.

Cet appareil numérique de la classe A respecte toutes les exigences du Règlement sur le matériel brouilleur du Canada.

History

Revision	Date	Change Made
334717 Rev. A	12/02	Initial release
338639 Rev. A	10/04	Updated software terminology and screen shots for BD FACSDiva software version 4.1
640752 Rev. A	5/06	Updated software terminology and screen shots for BD FACSDiva software version 5.0
642221 Rev A	6/07	Updated software terminology and screen shots for BD FACSDiva software version 6.0

Contents

About This Guide	xi
Conventions	xi
BD LSR II Documentation	xii
BD LSR II Online Help	xii
Printed Documentation	xiii
Electronic Documentation	xiv
Technical Assistance	xv
Safety and Limitations	xvii
Laser Safety	xvii
Laser Product Classification	xviii
Precautions for Safe Operation	xviii
Electrical Safety	xix
Biological Safety	xx
General Safety	xxi
Symbols and Labels	xxi
Limitations	xxiii
Chapter 1: Introduction	25
Overview	26
Components	26
Power Switch	26
Handles	27
Control Panel	27

Fluidics	28
Sample Flow Rate Control	28
Fluid Control	28
Sample Injection Port	29
Sheath and Waste Containers	31
Optics	32
Lasers	33
Filters	34
Detectors	35
BD LSR II Workstation	37
Chapter 2: Cytometer Setup	39
Starting the Cytometer and Computer	40
Setting Up the Optical Filters and Mirrors	41
Filter and Mirror Configurations	42
Changing Optical Filters or Mirrors	43
Filter and Mirror Specifications	44
Preparing Sheath and Waste Containers	45
Preparing the Waste Container	47
Preparing the Fluidics	48
Removing Air Bubbles	49
Priming the Fluidics	50
Quality Control	51
Chapter 3: Running Samples	53
Optimizing Your Cytometer	54
Preparing the Workspace	55
Setting Up an Experiment	58
Optimizing the Voltages and Threshold	63
Calculating Compensation	65
Recording and Analyzing Data	67

Preparing the Workspace	68
Recording Data	68
Analyzing Data	71
Reusing the Analysis	75
Saving the Analysis	75
Chapter 4: Maintenance	77
Maintaining the Cytometer	78
Daily Cleaning and Shutdown	78
Daily Fluidics Cleaning	78
Daily Shutdown	80
Scheduled Maintenance	80
System Flush	80
Waste Management System Maintenance	82
Periodic Maintenance	85
Changing the Sheath Filter	85
Changing the Bal Seal	88
Changing the Sample Tube O-Ring	90
Appendix A: Technical Overview	91
Fluidics	92
Optics	93
Light Scatter	93
Fluorescence	94
Optical Filters	95
Compensation Theory	99
Electronics	102
Pulse Measurements	104
Digital Electronics	105
Threshold	105
Laser Controls	106

Appendix B: Troubleshooting	107
Cytometer Troubleshooting	108
Appendix C: Supplies and Consumables	117
QC Particles	118
QC Cytometer Setup and Tracking Particles	118
Reagents	119
Equipment	120
Appendix D: Standard Base Configuration	121
4-Blue 2-Violet 2-355 UV 2-Red Configuration	122
Base Configuration	123
Octagon and Trigon Maps	124
Additional Optics	128
Appendix E: Special Order Configurations	133
Common Special Order Configurations	134
6-Blue 0-Violet 0-UV 3-Red Configuration	135
6-Blue 2-Violet 0-UV 3-Red Configuration	136
6-Blue 0-Violet 2-UV 3-Red Configuration	137
6-Blue 2-Violet 2-UV 3-Red Configuration	139
6-Blue 6-Violet 0-UV 3-Red Configuration	140
6-Blue 6-Violet 0-UV 4-Red Configuration	142
6-Blue 6-Violet 2-UV 3-Red Configuration	144
6-Blue 6-Violet 2-UV 4-Red Configuration	146
Special Order Configuration Trigon and Octagon Maps	148
6-Color Blue Octagon Default Configuration Map	149
2-Color Violet Trigon Default Configuration Map	150
6-Color Violet Octagon Default Configuration Map	151
2-Color UV Trigon Default Configuration Map	152
3-Color Red Trigon Default Configuration Map	153

4-Color Red Octagon Default Configuration Map	154
Appendix F: Setting Laser Delay	155
About Laser Delay	156
Optimizing Laser Delay	157
Index	159

About This Guide





This guide describes the procedures necessary to operate and maintain your BD™ LSR II flow cytometer. Because many cytometer functions are controlled by BD FACSDiva™ software, this guide also contains information about software features required for basic cytometer setup and operation.

For an annotated list of additional documentation for your BD LSR II flow cytometer, see BD LSR II Documentation on page xii.

Conventions

The following tables list conventions used throughout this guide. Table 1 lists the symbols that are used to alert you to a potential hazard. Text and keyboard conventions are shown in Table 2.

Table 1 Hazard symbols^a

Symbol	Meaning
	Caution: hazard or unsafe practice that could result in material damage, data loss, minor or severe injury, or death
	Electrical danger
	Laser radiation
	Biological risk

a. Although these symbols appear in color on the cytometer, they are in black and white throughout this user's guide; their meaning remains unchanged.

Table 2 Text and keyboard conventions

Convention	Use
 Tip	Highlights features or hints that can save time and prevent difficulties
NOTICE	Describes important features or instructions
<i>Italics</i>	Italics are used to highlight book titles and new or unfamiliar terms on their first appearance in the text.
>	The arrow indicates a menu choice. For example, “choose File > Print” means to choose Print from the File menu.
Ctrl-X	When used with key names, a dash means to press two keys simultaneously. For example, Ctrl-P means to hold down the Control key while pressing the letter <i>p</i> .

BD LSR II Documentation

BD LSR II Online Help

The online help installed with your BD FACSDiva software contains the same text as that in the documents listed below, enhanced with features like full text search and related topic links. Access BD LSR II online help from the Help menu of BD FACSDiva software.

BD LSR II online help topics are compiled from the following sources:

- *BD FACSDiva Software Reference Manual*
- *BD LSR II User's Guide*
- *BD High Throughput Sampler User's Guide*

Printed Documentation

A printed copy of the following documents is distributed with the BD LSR II flow cytometer:

- *BD LSR II User's Guide* describes procedures necessary to operate and maintain your BD LSR II flow cytometer. Because many cytometer functions are controlled by BD FACSDiva software, this guide also contains information about software features required for basic cytometer setup and operation.
- *BD LSR II Safety and Limitations* booklet discusses the safety features of the BD LSR II flow cytometer. It lists precautions for the cytometer's laser, electrical, and biological hazards, and states limitations of use.
- *BD LSR II Facility Requirement Guide* contains specifications for:
 - cytometer weight and size
 - temperature and other environmental requirements
 - electrical requirements
- *Getting Started with BD FACSDiva Software* contains tutorial exercises that familiarize you with key software procedures and concepts.
- A printed copy of the *BD High Throughput Sampler User's Guide* is distributed with the BD™ High Throughput Sampler (HTS) option. This document describes how to set up and operate the HTS. It also contains a description of BD FACSDiva software features specific to the HTS.

Electronic Documentation

PDF versions of the following documents can be found on the BD FACSDiva software installation disk or on your computer hard drive:

- The *BD FACSDiva Software Reference Manual* includes instructions or descriptions for installation and setup, workspace components, acquisition controls, analysis tools, and data management. It can be accessed from the BD FACSDiva Software Help menu (Help > Literature > Reference Manual), or by double-clicking the shortcut on the desktop. In addition, a printed copy can be requested from BD Biosciences.
- *Getting Started with BD FACSDiva Software* can be accessed from the Help menu (Help > Literature > Getting Started Guide), or by double-clicking the shortcut on the desktop.
- The *BD LSR II User's Guide* and *BD High Throughput Sampler User's Guide* PDFs can be found on the BD FACSDiva software installation disk in the Cytometer User Guides folder.
- The *BD FACSDiva Option White Paper* can be downloaded from the BD Biosciences website. This white paper contains an in-depth discussion of the digital electronics used in the BD LSR II cytometer.

Technical Assistance

For technical questions or assistance in solving a problem:

- Read sections of the documentation specific to the operation you are performing (see BD LSR II Documentation on page xii).
- See Troubleshooting on page 107.

If additional assistance is required, contact your local BD Biosciences customer support representative or supplier.

When contacting BD Biosciences, have the following information available:

- product name, part number, and serial number
- version of BD FACSDiva software you are using
- any error messages
- details of recent system performance

For cytometer support from within the US, call (877) 232-8995.

For support from within Canada, call (888) 259-0187.

Customers outside the US and Canada, contact your local BD representative or distributor.

Safety and Limitations

The BD LSR II flow cytometer and its accessories are equipped with safety features for your protection. Operate only as directed in the *BD LSR II User's Guide* and the *BD LSR II Safety and Limitations* booklet. Do not perform cytometer maintenance or service except as specifically stated. Keep this safety information available for reference.

Laser Safety



Lasers or laser systems emit intense, coherent electromagnetic radiation that has the potential of causing irreparable damage to human skin and eyes. The main hazard of laser radiation is direct or indirect exposure of the eye to thermal radiation from the visible and near-infrared spectral regions (325–1400 nm). Direct eye contact can cause corneal burns, retinal burns, or both, and possible blindness.



There are other potentially serious hazards in other spectral regions. Excessive ultraviolet exposure produces an intolerance to light (photophobia) accompanied by redness, a tearing discharge from the mucous membrane lining the inner surface of the eyelid (conjunctiva), shedding of the corneal cell layer surface (exfoliation), and stromal haze. These symptoms are associated with photokeratitis, otherwise known as snow blindness or welder's flash, which results from radiant energy-induced damage to the outer epidermal cell layer of the cornea. These effects can be the result of laser exposure lasting only a fraction of a second.



Laser Product Classification

Laser hazard levels depend on laser energy content and the wavelengths used. Therefore, it is impossible to apply common safety measures to all lasers. A numbered system is used to categorize lasers according to different hazard levels. The higher the classification number, the greater the potential hazard. The BD LSR II flow cytometer is a Class I (1) laser product per 21 CFR Subchapter J and IEC/EN 60825-1:1994 + A1:2003 + A2:2001. The lasers and the laser energy are fully contained within the cytometer structure and call for no special work area safety requirements except during service procedures. These procedures are to be carried out only by BD Biosciences service personnel.

Precautions for Safe Operation

  Modification or removal of the optics covers or laser shielding could result in exposure to hazardous laser radiation. To prevent irreparable damage to human skin and eyes, do not remove the optics covers or laser shielding, adjust controls, or attempt to service the cytometer any place where laser warning labels are attached (see Symbols and Labels on page xxi).

  Use of controls or adjustments or performance of procedures other than those specified in the user's guide may result in hazardous radiation exposure.

  Keep all cytometer doors closed during cytometer operation. When operated under these conditions, the cytometer poses no danger of exposure to hazardous laser radiation.

Electrical Safety



Lethal electrical hazards can be present in all lasers, particularly in laser power supplies. Every portion of the electrical system, including the printed circuit boards, should be considered to be at a dangerous voltage level. Avoid potential shock by following these guidelines.

- **Turn off the power switch and unplug the power cord** before servicing the cytometer, unless otherwise noted.
- Connect the equipment only to an approved power source. Do not use extension cords. Have an electrician immediately replace any damaged cords, plugs, or cables. Refer to the *BD LSR II Facilities Requirement Guide* for specific information.
- Do not remove the grounding prong from the power plug. Have a qualified electrician replace any ungrounded receptacles with properly grounded receptacles in accordance with the local electrical code.
- For installation outside the US, use a power transformer or conditioner to convert the local power source to meet the BD LSR II power requirements (120 V \pm 10%, 50/60 Hz). Contact your local BD office for further information.

Biological Safety





All biological specimens and materials coming into contact with them are considered biohazardous. Avoid exposure to biohazardous material by following these guidelines.

- Handle all biological specimens and materials as if capable of transmitting infection. Dispose of waste using proper precautions and in accordance with local regulations. Never pipette by mouth. Wear suitable protective clothing, eyewear, and gloves.
- Expose waste container contents to bleach (10% of total volume) for 30 minutes before disposal. Dispose of waste in accordance with local regulations. Use proper precaution and wear suitable protective clothing, eyewear, and gloves.
- Prevent waste overflow by emptying the waste container frequently or whenever the waste management system alarms.

For information on laboratory safety, refer to the following guidelines. NCCLS documents can be ordered online at www.nccls.org.



- Schmid I, Nicholson JKA, Giorgi JV, et al. Biosafety guidelines for sorting of unfixed cells. *Cytometry*. 1997;28:99-117.
- *Protection of Laboratory Workers from Instrument Biohazards and Infectious Disease Transmitted by Blood, Body Fluids, and Tissue; Approved Guideline*. Wayne, PA: National Committee for Clinical Laboratory Standards, 1997. NCCLS document M29-A.
- *Procedures for the Handling and Processing of Blood Specimens; Approved Guideline*. Wayne, PA: National Committee for Clinical Laboratory Standards; 1990. NCCLS document H18-A.







General Safety

-  The cytometer handles are for BD Biosciences authorized personnel only. Do not access them or attempt to lift the cytometer with them, or you could injure yourself.
-  To avoid burns, do not touch the fan guards on the back of the cytometer. The fan guards could be hot during and after cytometer operation.
-  Movement of mechanical parts within the cytometer can pinch or injure your hands or fingers. To prevent injury by moving parts, keep your hands and clothing away from the cytometer during operation.

Symbols and Labels

The following symbols, warnings, or precaution labels appear on the BD LSR II flow cytometer or the waste and fluid tanks.

Symbol	Meaning	Location(s)
	Dangerous voltage	Rear cytometer panel near power receptacle
	Laser radiation hazard	Near all removable covers and any place where the laser beam can emerge from the cytometer
	Caution! Consult accompanying documents.	Near the cytometer handles

Label	Meaning	Location(s)
 <p>CAUTION: Hot Surface</p> <p>ATTENTION: Surface Chaude</p> <p><small>334972</small></p>	<p>Caution Hot surface</p>	<p>Rear cytometer panel adjacent to exhaust fans</p>
 <p>CAUTION: Turn power off before service.</p> <p>ATTENTION: Mettre hors tension avant toute intervention.</p> <p><small>334974</small></p>	<p>Caution Turn power off before service.</p>	<ul style="list-style-type: none"> • Rear cytometer panel adjacent to power receptacle • Near internal power shield
 <p>CAUTION: High Voltage</p> <p>ATTENTION: Haute tension</p> <p><small>334973</small></p>	<p>Caution High voltage</p>	<p>Rear cytometer panel adjacent to power receptacle</p>
 <p>Waste (A)</p> <p><small>336325 Rev. A</small></p>	<p>Biological risk: Waste Risk of exposure to biologically transmittable disease</p>	<p>System waste tank</p>
 <p>DANGER VISIBLE AND/OR INVISIBLE LASER RADIATION WHEN REMOVED. AVOID EYE OR SKIN EXPOSURE TO DIRECT OR SCATTERED RADIATION.</p>	<p>Danger Visible and/or invisible laser radiation when removed. Avoid eye or skin exposure to direct or scattered radiation.</p>	<p>Near all removable covers and any place where the laser beam can emerge from the cytometer</p>
 <p>DANGER RAYONNEMENT LASER VISIBLE ET/OU INVISIBLE LORS DU RETRAIT EVITER L'EXPOSITION OCULAIRE OU CUTANEE AU RAYONNEMENT DIRECT OU DIFFUSE</p>	<p>Sheath</p>	<p>Near BD FACsFlow™ solution (sheath) port</p>

Limitations

For Research Use Only. Not for use in diagnostic or therapeutic procedures.

BD Biosciences delivers software and workstations that are intended for running the cytometers supplied by BD Biosciences. It is the responsibility of the buyer/user to ensure that all added electronic files including software and transport media are virus free. If the workstation is used for Internet access or purposes other than those specified by BD Biosciences, it is the buyer/user's responsibility to install and maintain up-to-date virus protection software. BD Biosciences does not make any warranty with respect to the workstation remaining virus free after installation. BD Biosciences is not liable for any claims related to or resulting from buyer/user's failure to install and maintain virus protection.

Introduction

The following topics are covered in this chapter:

- Overview on page 26
- Components on page 26
- Fluidics on page 28
- Optics on page 32
- BD LSR II Workstation on page 37

Overview

The BD LSR II is an air-cooled multi-laser benchtop flow cytometer with the ability to acquire parameters for a large number of colors. It uses fixed-alignment lasers that transmit light reflected by mirrors through a flow cell to user-configurable octagon and trigon detector arrays. These detectors collect and translate fluorescence signals into electronic signals. Cytometer electronics convert these signals into digital data.

Components

Figure 1-1 BD LSR II flow cytometer

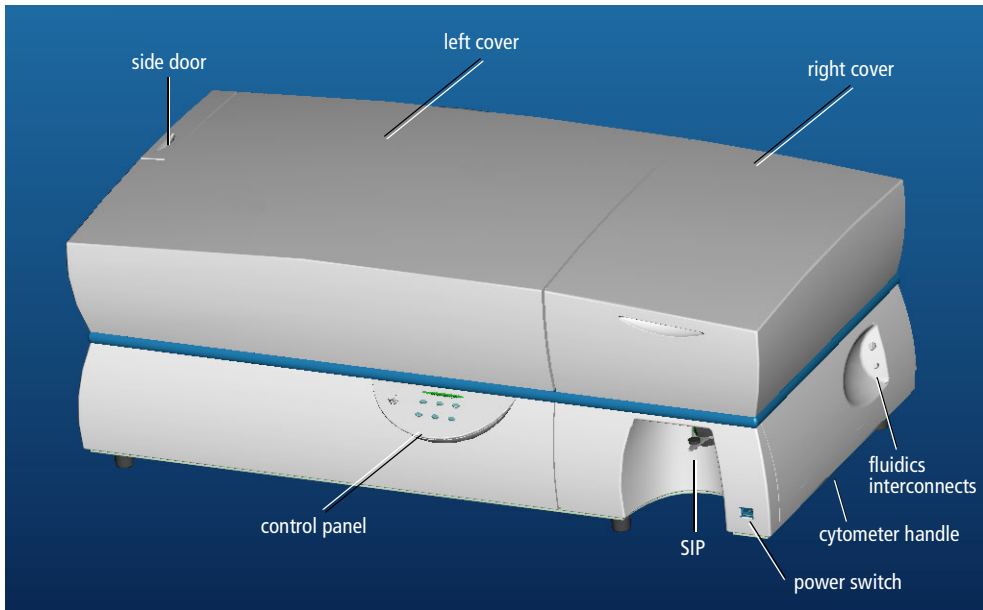

Power Switch

The power switch is located on the lower-right side of the BD LSR II cytometer.

Handles



The cytometer handles are for BD Biosciences authorized personnel only. Do not access them or attempt to lift the cytometer with them, or you could injure yourself.

Control Panel

The control panel contains the following fluidics controls:

- Sample Flow Rate Control buttons
- Fluid Control buttons
- Sample fine adjust knob

Figure 1-2 Control panel

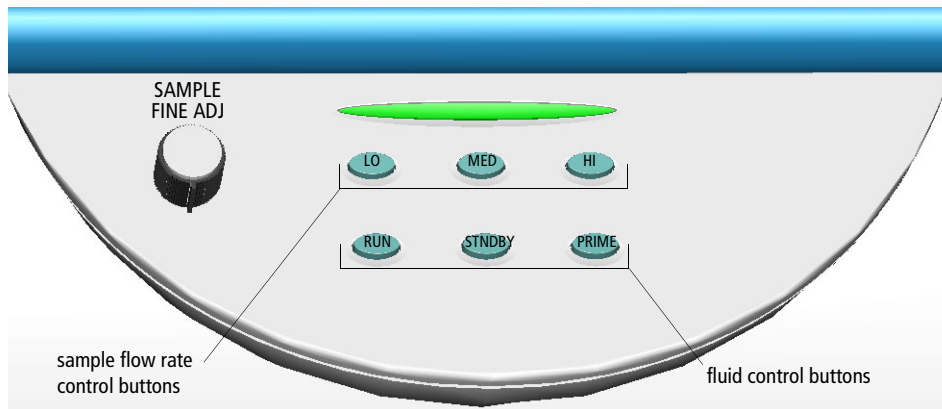

Fluidics

The purpose of the fluidics system is to carry the sample out of the sample tube and into the sensing region of the flow cell. Cells are carried in the sample core stream in single file and measured individually.

Sample Flow Rate Control

Three flow rate control buttons—LO, MED, and HI—set the sample flow rate through the flow cell. The SAMPLE FINE ADJ knob allows you to adjust the rate to intermediate levels (Figure 1-2 on page 27).

When the SAMPLE FINE ADJ knob is at its midpoint, the sample flow rates at the LO, MED, and HI settings are approximately 12, 35, and 60 $\mu\text{L}/\text{min}$ of sample, respectively. The knob turns five full revolutions in either direction from its midpoint, providing sample flow rates from 0.5–2X the midpoint value. For example, if the LO button is pressed, the knob will give flow rates from approximately 6–24 $\mu\text{L}/\text{min}$.

Fluid Control

Three fluid control buttons—RUN, STNDBY, and PRIME—set the cytometer mode (Figure 1-2 on page 27).

- RUN pressurizes the sample tube to transport the sample through the sample injection tube and into the flow cell.

The RUN button is green when the sample tube is on and the support arm is centered. When the tube support arm is moved left or right to remove a sample tube, the cytometer switches to an automatic standby status to conserve sheath fluid, and the RUN button changes to orange.

- STNDBY (standby) stops fluid flow to conserve sheath fluid.

When you leave the cytometer for more than a few minutes, place a tube containing 1 mL of deionized (DI) water on the sample injection port (SIP) and press STNDBY.

- PRIME prepares the fluidics system by draining and filling the flow cell with sheath fluid.

The fluid flow initially stops and pressure is reversed to force fluid out of the flow cell and into the waste container. After a preset time, the flow cell fills with sheath fluid at a controlled rate to prevent bubble formation or entrapment. At completion, the cytometer switches to STNDBY mode.

Sample Injection Port

The sample injection port (SIP) is where the sample tube is installed. The SIP includes the sample injection tube and the tube support arm. Samples are introduced through a stainless steel injection tube equipped with an outer droplet containment sleeve. The sleeve works in conjunction with a vacuum pump to eliminate droplet formation of sheath fluid as it backflushes from the sample injection tube.

Figure 1-3 Sample injection port (SIP)

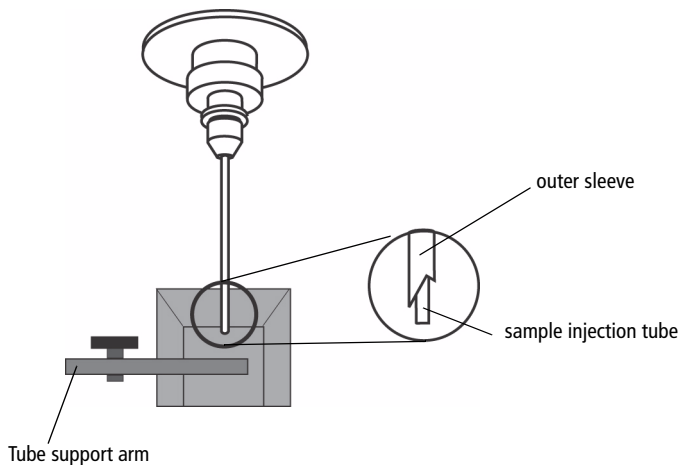

- Sample injection tube—Stainless steel tube that carries sample from the sample tube to the flow cell. This tube is covered with an outer sleeve that serves as part of the droplet containment system.
- Tube support arm—Arm that supports the sample tube and activates the droplet containment system vacuum. The vacuum is on when the arm is positioned to the side and off when the arm is centered.

Droplet Containment System

The droplet containment system prevents sheath fluid from dripping from the SIP and provides biohazard protection.

When no sample tube is installed on the SIP, sheath fluid backflushes through the sample injection tube. This backflush helps prevent carryover of cells between samples. The droplet containment system vacuum is activated when the sample tube is removed and the tube support arm is moved to the side. Sheath fluid is aspirated as it backflushes the sample injection tube.

NOTICE If a sample tube is left on the SIP with the tube support arm to the side (vacuum on), sample will be aspirated into the waste container.

Sheath and Waste Containers

The sheath and waste containers are outside the cytometer and are positioned on the floor.

Sheath Container



The sheath container has a capacity of 8 L. Sheath fluid is filtered through an in-line, interchangeable filter that prevents small particles from entering the sheath fluid lines.



Before opening the sheath container:

- 1 Press the STNDBY button.
- 2 Disconnect the air line (green).
- 3 Depressurize the sheath container by lifting its vent cap.

Waste Container

The waste container has a capacity of 10 L. An alarm sounds when the container becomes full.

  To avoid leakage of biohazardous waste, put the cytometer in standby mode before disconnecting the waste container.

  The waste container contents might be biohazardous. Treat contents with bleach (10% of total volume). Dispose of waste with proper precautions in accordance with local regulations. Wear suitable protective clothing, eyewear, and gloves.

 The waste container is heavy when full. When emptying it, use good body mechanics to prevent injury.

Optics

The following figure shows the optical bench components of the BD LSR II cytometer.

Figure 1-4 Optical bench components (engineering model)

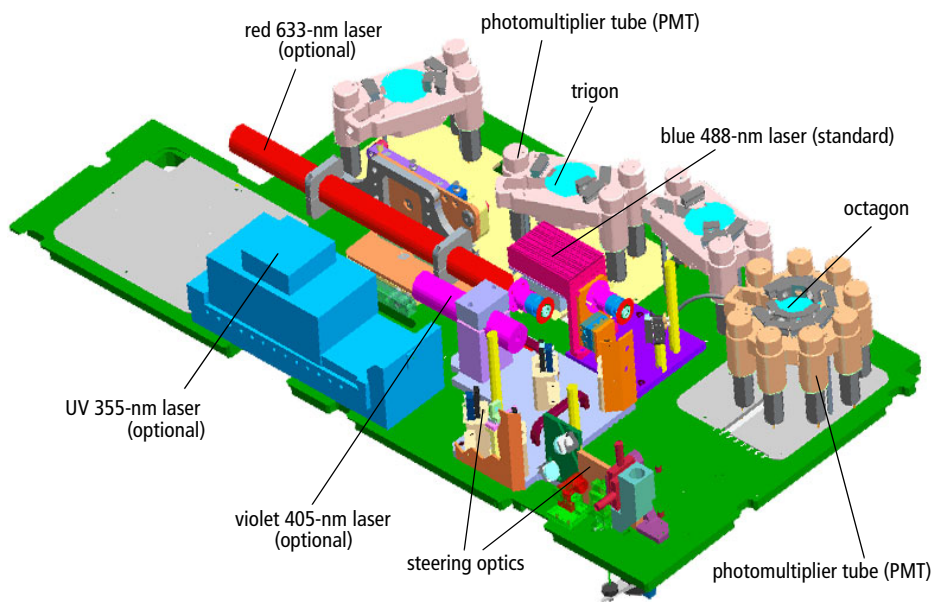

Photomultiplier tubes (PMTs)	Devices that convert optical signals into electrical signals (see Detectors on page 35)
Octagon	Array of PMTs and filters that can detect up to eight signals (Figure 1-5 on page 35)
Trigon	Array of PMTs and filters that can detect up to three signals (Figure 1-6 on page 36)

Lasers: blue 488 nm, red 633 nm, UV 355 nm, and violet 405 nm	See Lasers on page 33.
Optics cover	Shielding that houses the flow cell, forward scatter (FSC) assembly (see Detectors on page 35), and the excitation optics

Lasers

The BD LSR II flow cytometer has a fixed-alignment 488-nm laser with the option of additional fixed-alignment lasers.

Table 1-1 BD LSR II flow cytometer laser options

	Lasers	Type	Wavelength (Color)	Power (mW)	Warm-Up Time (min)
Standard	Coherent [®] Sapphire [™]	solid state	488 nm (blue)	20	30
Optional	JDS Uniphase [™] 1344P	helium-neon (HeNe) gas	633 nm (red)	17	20
	Coherent Radius [™] 405	solid state	405 nm (violet)	25	15
	Lightwave Xcyte [™]	solid state	355 nm (UV)	20	30

The primary blue 488-nm laser (Coherent Sapphire) generates forward scatter (FSC) and side scatter (SSC) signals and four fluorescence signals.

- The optional red 633-nm laser (JDS Uniphase 1344P) generates two fluorescence signals.
- The optional violet 405-nm laser (Coherent Radius 405) generates two fluorescence signals.
- The optional UV 355-nm laser (Lightwave Xcyte) generates two fluorescence signals.

Filters

Optical filters attenuate light or help direct it to the appropriate detectors. The BD LSR II cytometer uses dichroic filters. Dichroic filters transmit light of a specific wavelength, while reflecting other wavelengths. The name and spectral characteristics of each filter appear on its holder.

There are three types of dichroic filters:

- Shortpass (SP) filters transmit wavelengths that are shorter than the specified value.
- Longpass (LP) filters transmit wavelengths that are longer than the specified value.
- Bandpass (BP) filters pass a narrow spectral band of light by combining the characteristics of shortpass filters, longpass filters, and absorbing layers. Discriminating filters (DF) and ALPHA™ filters (AF) are types of bandpass filters.

When dichroic filters are used as steering optics to direct different color light signals to different detectors, they are called dichroic mirrors or beam splitters.

- Shortpass dichroic mirrors transmit shorter wavelengths of light to one detector while reflecting longer wavelengths to a different detector.
- Longpass dichroic mirrors transmit longer wavelengths to one detector while reflecting shorter wavelengths to a different detector.

The BD LSR II cytometer octagon and trigon detector arrays use dichroic longpass mirrors on their inner rings, and bandpass filters on their outer rings. However, you can customize the arrays with other types of filters and mirrors.

In the following figure, the inner ring is colored gray, and the outer is blue.

Figure 1-5 Dichroic filter types in octagon array

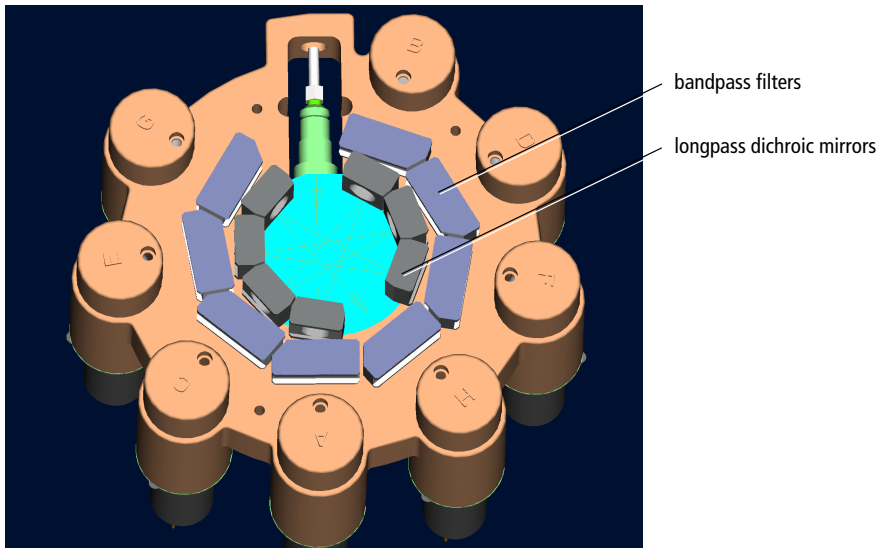

The steering optics and filters mounted on the BD LSR II cytometer are listed in Table D-1 on page 122.

See Optical Filters on page 95 for a more detailed explanation of how filters work in the BD LSR II flow cytometer.

Detectors

Light signals are generated as particles pass through the laser beam in a fluid stream. When these optical signals reach a detector, electrical pulses are created that are then processed by the electronics system.

There are two types of signal detectors in the BD LSR II flow cytometer:

- Photodiode tubes—Less sensitive to light signals than the PMTs. A photodiode is used to detect the stronger forward scatter signal.
- Photomultiplier tubes (PMTs)—Used to detect the weaker signals generated by side scatter and all fluorescence channels. These signals are amplified by applying a voltage to the PMTs.

As the voltage is increased, the detector sensitivity increases, resulting in increased signal. As the voltage is decreased, the detector sensitivity decreases, resulting in decreased signal. Detector voltages are adjusted in BD FACSDiva software.

Figure 1-6 PMT-type detectors in trigon array

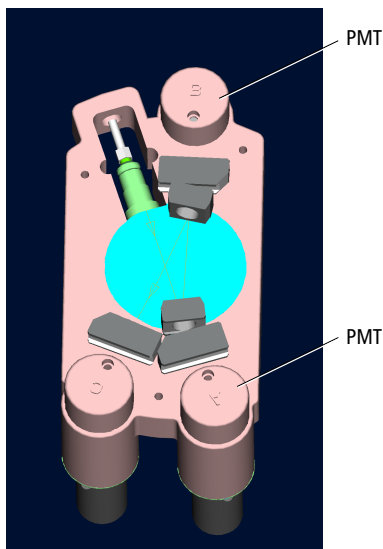

The default locations of specific detectors and filters within BD LSR II cytometer octagon and trigon arrays are shown in Table D-1 on page 122.

BD LSR II Workstation

Acquisition, analysis, and most BD LSR II cytometer functions are controlled by the BD LSR II workstation. It includes a PC, one or two monitors, and a printer.

Your workstation is equipped with the following:

- a BD Biosciences–validated Microsoft® Windows® operating system
- BD FACSDiva software for data acquisition and analysis
- software documentation including an online help system

See BD LSR II Documentation on page xii for more information.

2

Cytometer Setup

- Starting the Cytometer and Computer on page 40
- Setting Up the Optical Filters and Mirrors on page 41
- Preparing Sheath and Waste Containers on page 45
- Preparing the Fluidics on page 48
- Quality Control on page 51

Starting the Cytometer and Computer

- 1 Turn on the power to the flow cytometer. Allow 30 minutes for lasers to warm up and stabilize.



Failure to warm up and stabilize the lasers could affect sample data.

- 2 Start up the BD LSR II workstation and log in to Windows.



Tip You can turn on the power to the flow cytometer and the workstation in any order.

- 3 Start BD FACSDiva software by double-clicking the shortcut on the desktop, and log in to the software.
- 4 Check the Cytometer window in BD FACSDiva software to ensure the cytometer is connected to the workstation.

The cytometer connects automatically. While connecting, the message *Cytometer Connecting* is displayed in the window footer. When connection completes, the message changes to *Cytometer Connected*.

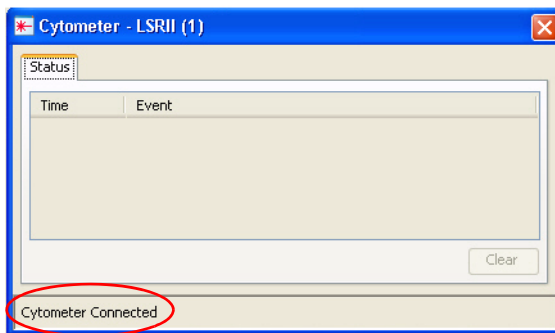

If the message *Cytometer Disconnected* appears, refer to Electronics Troubleshooting in Troubleshooting on page 107

Setting Up the Optical Filters and Mirrors

Before you run samples, set up the optical filters. The following figure shows the location of the detector arrays (beneath the cytometer covers of the BD LSR II flow cytometer). Each detector array is labeled with its laser source.

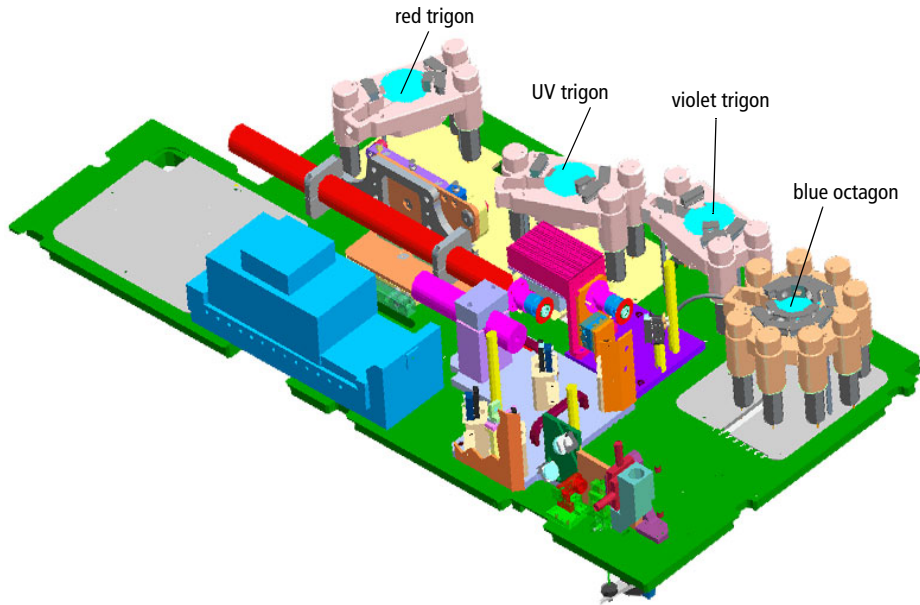

Filter and Mirror Configurations

Each PMT (except the last PMT in every detector array) has two slots in front of it.

- The slot closer to the PMT holds a bandpass filter holder.
- The slot farther from the PMT holds a longpass dichroic mirror holder.

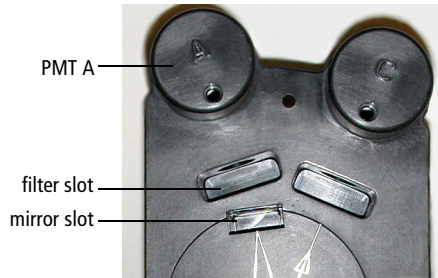

The last PMT in every detector array (PMT H in the octagon, and PMT C in all trigons) does not have a mirror slot.

Optical Holders, Filters, and Mirrors

Optical holders house filters and mirrors. Your cytometer includes several blank (empty) optical holders.

Figure 2-1 Blank optical holders, filters, and mirrors

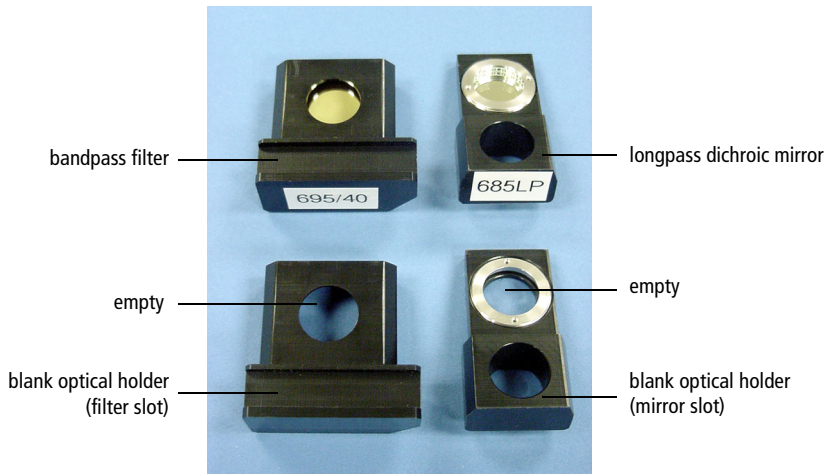

NOTICE To ensure data integrity, do not leave any slots unfilled in a detector array when you are using the associated laser. Always use a blank optical holder.

Base Configurations

Each BD LSR II cytometer has a base cytometer configuration that corresponds to the layout of the installed lasers and optics in your cytometer.

BD FACSDiva Cytometer Configuration

Before you acquire data using BD FACSDiva software, you specify a cytometer configuration. The cytometer configuration defines which filter and mirror are installed at each detector.

BD FACSDiva software provides a BD base configuration for your BD LSR II cytometer. Use the Cytometer Configuration dialog to create, modify, or delete custom cytometer configurations. (Refer to the Cytometer and Acquisition Controls chapter of the *BD FACSDiva Software Reference Manual* for details.)

Changing Optical Filters or Mirrors



Follow the precautions outlined in Laser Safety on page xvii while changing optical filters or mirrors.

- 1 Lift the appropriate cytometer cover.
 - The octagon array is located under the right cytometer cover.
 - The three trigon arrays are located under the left cytometer cover.

NOTICE To open the left cytometer cover, you must first open the right cover and the side door.

- 2 Remove the appropriate filter holder or mirror holder.

- 3 Replace it with the new filter holder or mirror holder.

Tip The filter and mirror holders fit easily into the slots only one way.

- 4 Close the cytometer cover(s).

Additional Optical Filters and Mirrors

See Additional Optics on page 128 for optical maps of some common custom filter and mirror configurations. The filters and mirrors used in these configurations are included with your spares kit (Table 2-1 on page 44).

Filter and Mirror Specifications

Table 2-1 Longpass dichroic mirrors in octagon or trigon

Specification	Measurement
Diameter	0.625 in. +0.000, -0.005
Minimum clear aperture	0.562 in.
Incident angle	11.25°
Thickness	0.125 in. ±0.005 in.

Table 2-2 Bandpass filters in octagon or trigon

Specification	Measurement
Diameter	1.00 in. ±0.010 in.
Minimum clear aperture	0.85 in.
Incident angle	0°
Thickness	0.12–0.35 in.

Preparing Sheath and Waste Containers

- ☑ **Tip** Check the fluid levels in the sheath and waste containers every time you use the cytometer. This ensures that you do not run out of sheath fluid during an experiment and that the waste container does not become too full.

Figure 2-2 Sheath container

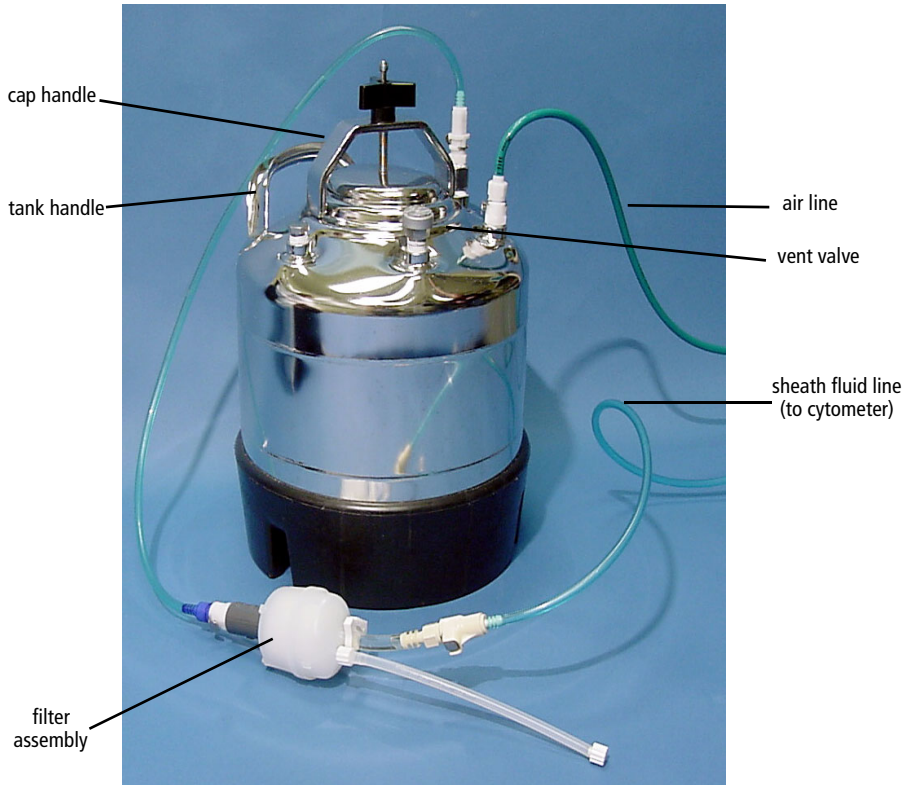

To prepare the sheath container:

- 1** Verify that the flow cytometer is in standby mode.
- 2** Disconnect the air line (green) from the sheath container.
- 3** Depressurize the sheath container by pulling up on the vent valve.
- 4** Remove the sheath container lid. Unscrew the clamp knob and lift.
- 5** Add 6 L of sheath fluid, such as BD FACSSlow solution, to the sheath container.



Do not fill the sheath tank to its maximum capacity (8 L). When an over-full tank is pressurized, erratic cytometer performance can result.

- 6** Replace the sheath container lid.
 - 7** Reconnect the air line (green).
 - 8** Make sure that the lid is tightly sealed with the gasket in place, the clamp knob is finger-tight, and the cytometer fluid line (blue) is not kinked.
- TIP** Inspect the sheath container periodically, since sheath fluid can cause corrosion.

Preparing the Waste Container



  All biological specimens and materials coming into contact with them are considered biohazardous. Handle as if capable of transmitting infection. Dispose of waste using proper precautions and in accordance with local regulations. Never pipette by mouth. Wear suitable protective clothing, eyewear, and gloves.

Figure 2-3 Waste container



To prepare the waste container:

- 1 Disconnect the orange waste tubing and the black level sensor line from the waste container. Keep the lid on the waste container until you are ready to empty it.
- 2 Empty the waste container.

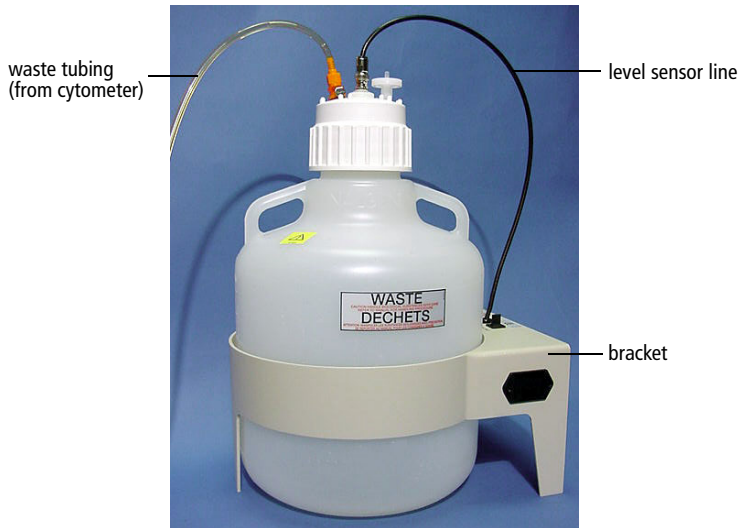

The waste container contents might be biohazardous. Treat contents with bleach (10% of total volume). Dispose of waste using proper precautions and in accordance with local regulations. Wear suitable protective clothing, eyewear, and gloves.

- 3 Add approximately 1 L of bleach to the waste container and close it.
- 4 Reconnect the orange waste tubing and make sure it is not kinked.
- 5 Reconnect the level sensor line.

Preparing the Fluidics

Make sure the fluidics system is ready. This section describes the following preparations:

- Removing air bubbles
- Priming the fluidics

Removing Air Bubbles

Trapped air bubbles in the sheath filter and the sheath line can occasionally dislodge and pass through the flow cell, resulting in inaccurate data.

- Tip** Do not vigorously shake, bend, or rattle the sheath filter or you might damage it.

To remove air bubbles:

- 1** Check the sheath filter for trapped air bubbles.
- 2** If bubbles are visible, gently tap the filter body with your fingers to dislodge the bubbles and force them to the top.
- 3** Pinch the vent line closed (Figure 2-4 on page 50).
- 4** Loosen the sheath filter vent cap to bleed off any air in the filter. Collect the excess fluid in a container.
- 5** Replace the vent cap.
- 6** Check the sheath line for air bubbles.
- 7** Open the roller clamp at the fluidics interconnect (if necessary) to bleed off any air in the line. Collect any excess fluid in a waste container.
- 8** Close the roller clamp.

Figure 2-4 Sheath filter

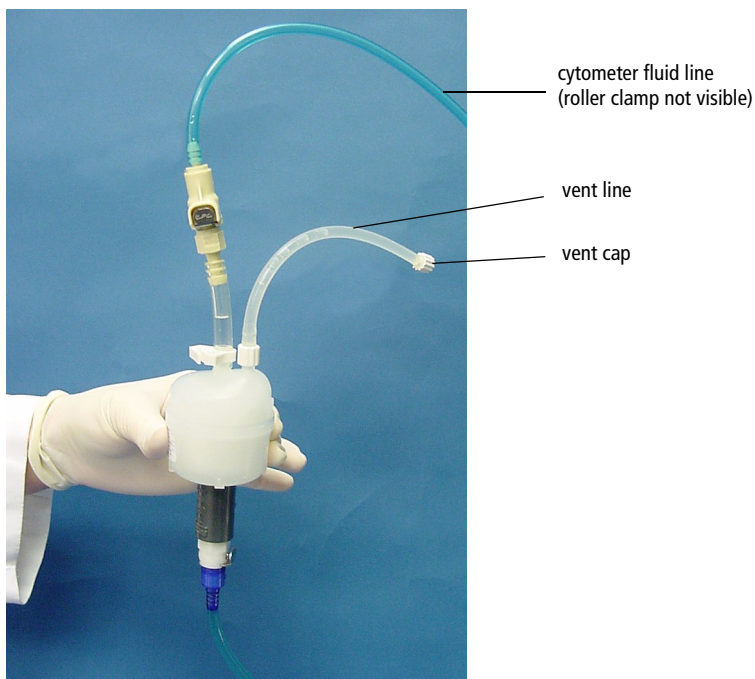

Priming the Fluidics

Sometimes, air bubbles and debris are stuck in the flow cell. This is indicated by excessive noise in the forward scatter parameter. In these cases, it is necessary to prime the fluidics system.

To prime the fluidics:

- 1** Remove the tube from the SIP.
- 2** Press the PRIME fluid control button to force the fluid out of the flow cell and into the waste container.

Once drained, the flow cell automatically fills with sheath fluid at a controlled rate to prevent bubble formation or entrapment. The STNDBY button turns amber after completion.

- 3** Repeat the priming procedure, if needed.
- 4** Install a 12 x 75-mm tube with 1 mL of DI water on the SIP and place the support arm under the tube. Leave the cytometer in standby mode.

Quality Control

A cytometer quality control (QC) procedure, performed on a regular basis, provides a standard for monitoring cytometer performance. Cytometer QC consists of running QC samples and recording the results.

QC results are affected by laser and fluidics performance. We strongly recommend following the laser and fluidics maintenance procedures (see Maintenance on page 77).

If you plan to manually set up and run QC procedures, see QC Particles on page 118 for a list of acceptable QC beads.

If you plan to use Cytometer Setup and Tracking, refer to the *Cytometer Setup and Tracking Application Guide* for information.

3

Running Samples

This chapter describes procedures that use BD FACSDiva software to record and analyze sample data:

- Optimizing Your Cytometer on page 54
- Recording and Analyzing Data on page 67

Before You Begin

Before you perform the procedures in this chapter, you should be familiar with:

- BD LSR II cytometer startup, setup, and QC procedures (see Cytometer Setup on page 39)
- BD FACSDiva software concepts: workspace components, cytometer and acquisition controls, tools for data analysis

To become familiar with BD FACSDiva software, perform the tutorial exercises in *BD FACSDiva Software Quick Start Guide*.

For additional details, refer to the *BD FACSDiva Software Reference Manual*.

Optimizing Your Cytometer

Before you record data for a sample, optimize the cytometer settings for the sample type and fluorochromes used. This section describes how to optimize the settings using the Compensation Setup feature of BD FACSDiva software. It does not use the CS&T application to generate the baseline settings. See the *Cytometer Setup and Tracking Application Guide* for information.

Note that compensation setup automatically calculates compensation settings. If you select to perform compensation manually, not all of the following instructions apply. For detailed instructions, refer to the *BD FACSDiva Software Reference Manual*.

To optimize settings:

- 1 Prepare the workspace.
- 2 Optimize voltages and the threshold setting.
- 3 Record the compensation tubes.
- 4 Calculate compensation settings.

The data shown in this example is from a 4-color bead sample with the following fluorochromes:

- FITC
- PE
- PerCP-Cy5.5
- APC

To perform this example exercise:

Prepare an unstained control tube and single-stained tubes for each fluorochrome.

If you follow this procedure with a different bead sample (or another sample type), your software views, data plots, and statistics might differ from the example. Additionally, you might need to modify some of the instructions in the procedure.

Preparing the Workspace

To prepare your workspace for running samples, you need to verify the cytometer configuration and your user preferences, and create a new experiment.

Verifying the Cytometer Configuration and User Preferences

To obtain accurate data results, the current cytometer configuration must reflect your BD LSR II cytometer optics.

To verify the configuration and preferences before you create an experiment:

- 1 Select Cytometer > View Configurations and verify the current configuration.

Figure 3-1 Cytometer Configuration dialog

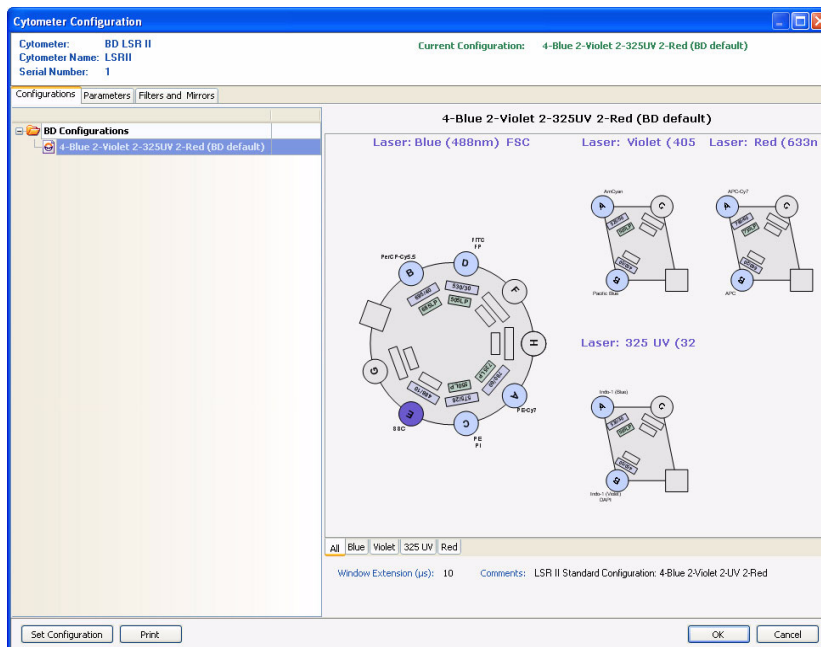

NOTICE Your cytometer will include only one base configuration when your cytometer is installed. You can create additional configurations as needed at a later time.

In the Configurations tab, select a configuration. For your bead sample, the cytometer configuration must include the following parameters: FITC, PE, PerCP-Cy5.5, and APC.

- 2 Click OK to close the dialog.
- 3 Select Edit > User Preferences.

- 4 Select the General tab and deselect all checkboxes except the *Load data after recording* checkbox.

Figure 3-2 User Preferences dialog

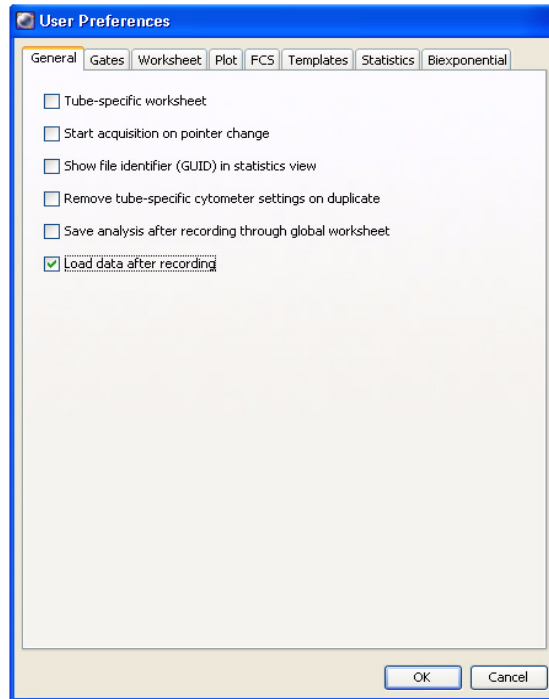





Refer to the *BD FACSDiva Software Reference Manual* for more information about cytometer configuration and user preferences.

Setting Up an Experiment

In this section, you create an experiment in a new folder, specify the parameters of the experiment, and add compensation tubes.

To create an experiment:

1 Click the buttons on the Workspace toolbar to display windows as needed:

- Browser 
- Cytometer 
- Inspector 
- Worksheet 
- Acquisition Dashboard 

When you add elements or make selections in the Browser window, the Inspector window displays details, properties, and options that correspond to your selection.

2 Click the New Folder button () on the Browser toolbar to add a new folder.

3 Click the folder and rename it *MyFolder*.

4 Click MyFolder, then click the New Experiment button on the Browser toolbar, or right-click the new folder and select New Experiment from the menu.

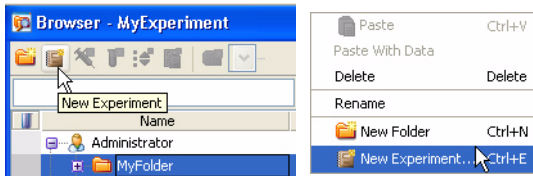

5 Click the new experiment in Browser and rename it *MyExperiment*.

- 6 Select MyExperiment in the Browser. The Inspector displays details for MyExperiment.

To specify the parameters for the new experiment:

- 1 Select Cytometer Settings for the experiment in the Browser.

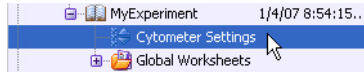

- 2 Cytometer settings appear in the Inspector.

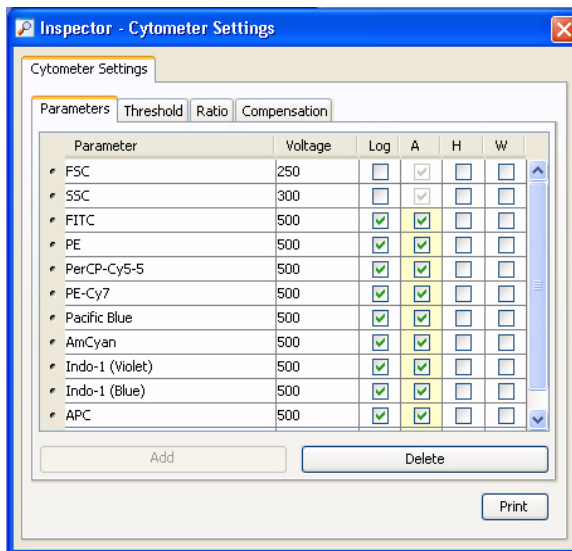

- 3 Make sure the parameters you need appear on the Parameters tab in the Inspector.

If more than one parameter is available for a particular PMT, you might have to select the one you need from a menu. For example, you can set Detector D for the blue laser as FITC or FP.

- Click the Parameter name to display the available fluorochromes in the Parameters list.

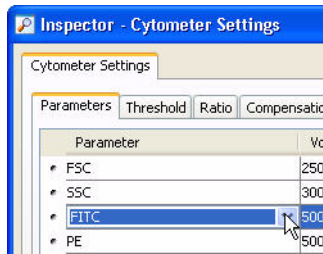

- Select the specific parameter from the drop-down list. Your selection appears as the selected parameter.

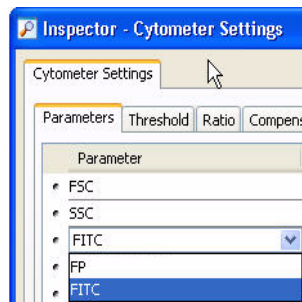

For this example, select FITC from the menu.

- 4 Delete any unnecessary parameters.

- Click the selection button (on the left side of the pane) to select the parameter.

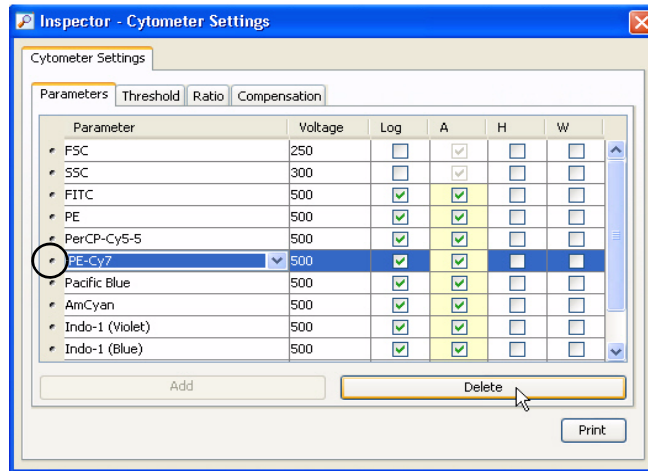

- Click Delete. The parameter is deleted.

To create compensation control tubes:

- 1 Select Experiment > Compensation Setup > Create Compensation Controls.

The Create Compensation Controls dialog appears.

For this bead example, you do not need to provide non-generic tube labels.

Figure 3-3 Create Compensation Controls

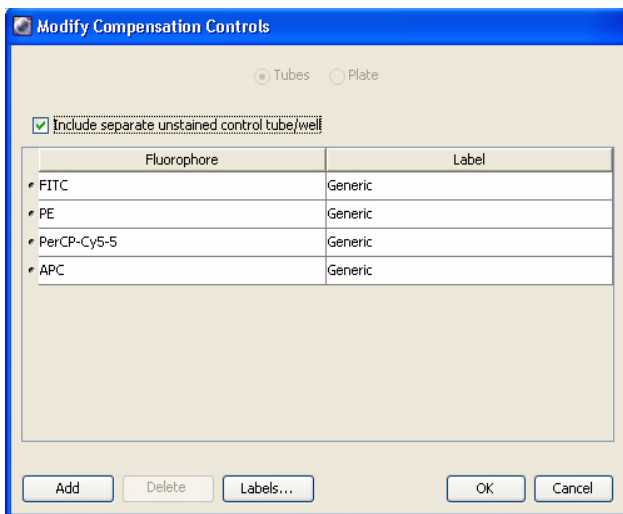

- 2 Click OK to create the control tubes.

Compensation control tubes are added to the experiment. Worksheets containing appropriate plots and gates are added for each compensation tube.

Figure 3-4 Compensation tubes

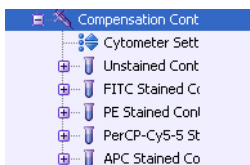

Optimizing the Voltages and Threshold

In this section, you use the unstained control tube to adjust FSC and SSC voltages and FSC threshold to gate the population of interest (bead singlets, in this case), and to adjust fluorescence PMT voltages.

To optimize settings:

- 1** Press RUN and HI on the cytometer fluid control panel.
- 2** Install the unstained control tube onto the SIP.
- 3** Expand the Compensation Controls specimen in the Browser.
- 4** Click to set the current tube pointer next to the unstained control tube (it becomes green), then click Acquire Data in the Acquisition Dashboard.
- 5** Adjust the FSC and SSC voltages to place the population on scale.
 - Click the Parameters tab in the Cytometer window.
 - Use the up and down arrows or drag the voltage sliders to adjust the voltage settings.
- 6** Click the Threshold tab and adjust the FSC threshold, if needed.

Adjust the FSC threshold to remove most of the debris without clipping the singlet population.
- 7** Install the unstained control tube onto the SIP.
- 8** Adjust the P1 gate on the Unstained Control worksheet, as needed, to encompass only the singlet population.

Figure 3-5 P1 gate adjusted to singlet population

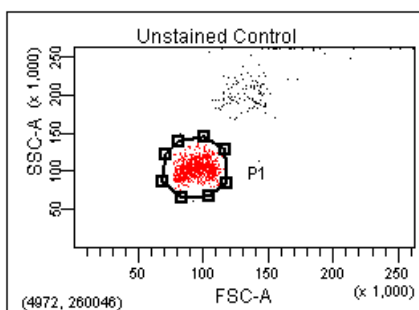

- 9 Right-click the gate and select Apply to All Compensation Controls.

The P1 gate on each Stained Control worksheet is updated with your changes.

- 10 Enter baseline PMT values, then verify that the positive sample is on scale. The baseline PMT voltage settings were established by performing the steps described in *Establishing Optimum Baseline PMT Gains to Maximize Resolution on BD Biosciences Digital Flow Cytometers* (Part No. 23-8359-00).

NOTICE If you significantly lower the PMT voltage below the original setting in order to bring the positive population on scale, the dim positive population might not be easily resolved from the negative population for that parameter.

- 11 Click Record Data.

When all events have been recorded, remove the unstained control tube from the cytometer.



Do not change the PMT voltages after the first compensation control has been recorded. In order to calculate compensation, all controls must be recorded with the same PMT voltage settings. If you need to adjust the PMT voltage for a subsequent compensation control, you must record all compensation controls again.

Calculating Compensation

Before you can calculate compensation, you need to record data for each single-stained control.

To record data for each single-stained control:

- 1** Install the first stained control tube onto the SIP.
- 2** In the Acquisition Dashboard, click Next Tube, and then Acquire Data. You can also set the current tube pointer to the next tube and click the pointer to start acquisition.
- 3** Click Record Data, or Alt-click the current tube pointer to record data.
- 4** When recording is finished, install the next stained control tube onto the SIP.
- 5** Repeat steps 2 through 4 until data for all stained control tubes has been recorded.
- 6** Install a tube of DI water onto the SIP. Place the cytometer in standby mode.
- 7** Double-click the first stained control tube (FITC stained control) to display the corresponding worksheet.
- 8** Verify that the snap-to interval gate surrounds the fluorescence-positive peak on the histogram. Adjust the gate, if needed.

Figure 3-6 Gating the positive population

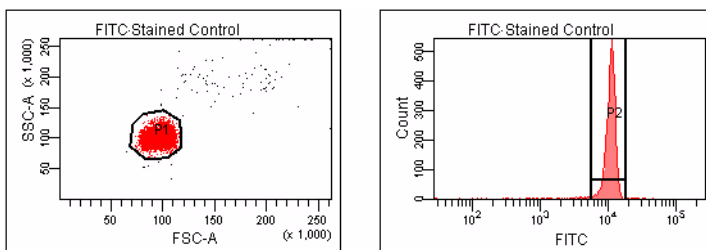

- 9 Repeat steps 7 and 8 for the remaining compensation tubes.

To calculate compensation:

- 1 Select Experiment > Compensation Setup > Calculate Compensation.

If the calculation is successful, a dialog is displayed where you can enter a name for the compensation setup.

- 2 Enter a setup name and click Link & Save.

The compensation is linked to the cytometer settings and saved to the catalog.

- Tip** To help track compensation setups, include the experiment name, date, or both in the setup name.

The compensation setup is linked to the *MyExperiment* cytometer settings, and subsequent acquisitions in *MyExperiment* are performed with the new compensation settings.

NOTICE BD Biosciences recommends that you always visually and statistically inspect automatically calculated overlap values. The means of the positive controls should be aligned with the means of the negative.

Recording and Analyzing Data

This section outlines some basic acquisition and analysis tasks using BD FACSDiva software. The example shows data from two 4-color bead samples with the following fluorochromes:

- FITC
- PE
- PerCP-Cy5.5
- APC

The procedure builds on the results obtained in the previous exercise: *Optimizing Your Cytometer* on page 54.

To perform this procedure:

Prepare two tubes containing all four fluorochromes.

If you use a different sample type (or if you have skipped the optimization exercise), your software window content and your data plots and statistics might differ from those shown here. You might also need to modify some of the instructions in the procedure.

For additional details on completing some of the steps below, refer to the *BD FACSDiva Software Reference Manual*.

Preparing the Workspace

In this section, you prepare your workspace before recording data.

To prepare the workspace:

- 1 Using the Browser toolbar, create a new specimen in MyExperiment and rename it *FourColorBeads*.
 - 2 Create two tubes for the FourColorBeads specimen. Rename the tubes *Beads_001* and *Beads_002*.
 - 3 Expand the Global Worksheets folder in MyExperiment to access the default global worksheet, and rename the worksheet *MyData*.
 - 4 On the MyData worksheet, create the following plots for previewing the data:
 - FSC vs SSC
 - FITC vs PE
 - FITC vs PerCP-Cy5.5
 - FITC vs APC
- Tip** Double-click the Dot Plot button to keep the button selected until you create all plots.

Recording Data

In this section, you preview and record data for multiple samples.

To record data:

- 1 Press RUN and HI on the cytometer fluid control panel.
- 2 Install the first sample tube onto the SIP.

- 3 Set the current tube pointer to Beads_001.
- 4 Click Acquire Data in the Acquisition Dashboard to begin acquisition.
- 5 While data is being acquired:
 - Draw a gate around the singlets on the FCS vs SSC plot.
 - Rename the P1 gate to *Singlets*.
 - Use the Inspector to set the other plots to show only the singlet population by selecting the singlets checkbox.

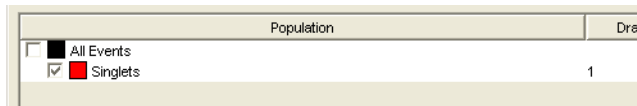

- 6 Click Record Data.
- 7 When event recording has completed, remove the first tube from the cytometer.

The MyData worksheet plots should look like the following figure.

Figure 3-7 Recorded data showing singlet population

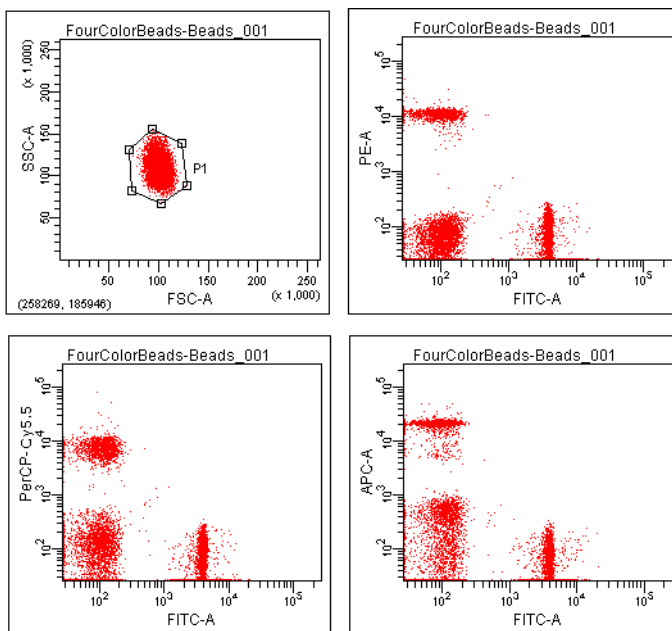

- 8** Install the second sample tube onto the SIP.
- 9** Set the current tube pointer to Beads_002.
- 10** Click Acquire Data to begin acquisition.

Before recording, preview the data on the MyData worksheet.
- 11** Click Record Data.
- 12** When event recording has completed, remove the second tube from the cytometer.
- 13** If you are recording more than two tubes, repeat steps 8 through 12 for the additional tubes.

- 14** Print the experiment-level cytometer settings. Right-click the Cytometer Settings icon in the Browser and select Print.
- 15** Install a tube of DI water onto the SIP. Place the cytometer in standby mode.

Analyzing Data

In this section, you analyze the recorded tubes by creating plots, gates, a population hierarchy, and statistics views on a new global worksheet. When complete, your new global worksheet should look like Figure 3-8 on page 74.

To analyze data:

- 1** Use the Browser toolbar to create a new global worksheet. Rename it *MyDataAnalysis*.
- 2** Create the following plots on the MyDataAnalysis worksheet:
 - FSC vs SSC
 - FITC vs PE
 - FITC vs PerCP-Cy5.5
 - FITC vs APC
- 3** Create a population hierarchy and a statistics view, and set them below the plots on the worksheet.
 - Right-click any plot and select Show Population Hierarchy.
 - Right-click any plot and select Create Statistics View.
- 4** Set the current tube pointer to Beads_001.
- 5** Draw a gate around the singlets on the FSC vs SSC plot.
- 6** Use the population hierarchy to rename the population *Singlets*.

- 7 Select all plots except the FSC vs SSC plot, and use the Plot tab in the Inspector to specify to show only the singlet population.
- 8 Select all plots, and click the Title tab in the Inspector. Select the Tube and Populations checkboxes to display their names in plot titles.

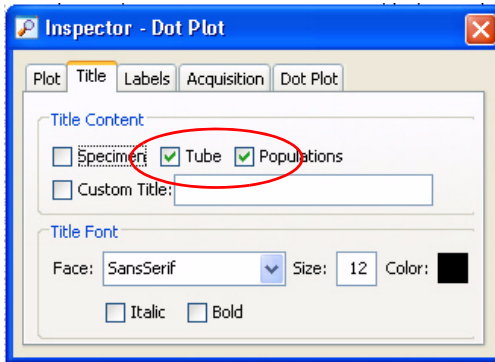

- 9 On all fluorescence plots:
 - Make all plots biexponential. Select all fluorescence plots and select the X Axis and Y Axis checkboxes in the Plot tab of the Inspector.

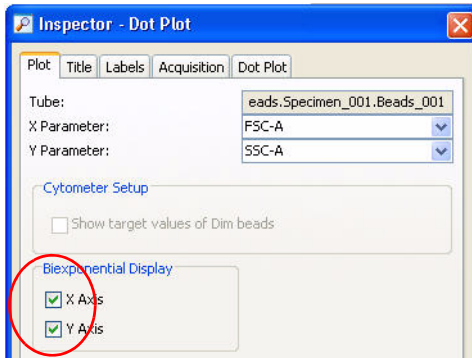

- Draw a gate around the FITC-positive population, for the first plot only, and name the population *FITC positive* in the population hierarchy.

- Draw a gate around the PE-positive population, and name the population *PE positive* in the population hierarchy.
- Draw a gate around the PerCP-Cy5.5-positive population, and name the population *PerCP-Cy5.5 positive* in the population hierarchy.
- Draw a gate around the APC-positive population, and name the population *APC positive* in the population hierarchy.

10 Format the statistics view.

- Right-click the statistics view and select Edit Statistics View.
- Click the Header tab and select the Specimen Name and Tube Name checkboxes.
- Click the Populations tabs and select all populations except All Events. Deselect the %Parent, %Total, and #Events checkboxes.
- Click the Statistics tab and select the mean for each of the fluorescence parameters.

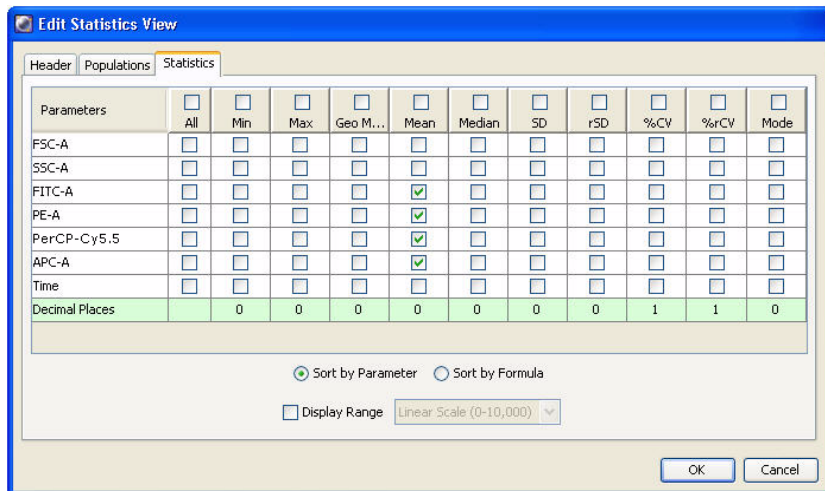

- Click OK.

11 Print the analysis.

Your global worksheet analysis objects should look like the following figure.

Figure 3-8 Bead analysis

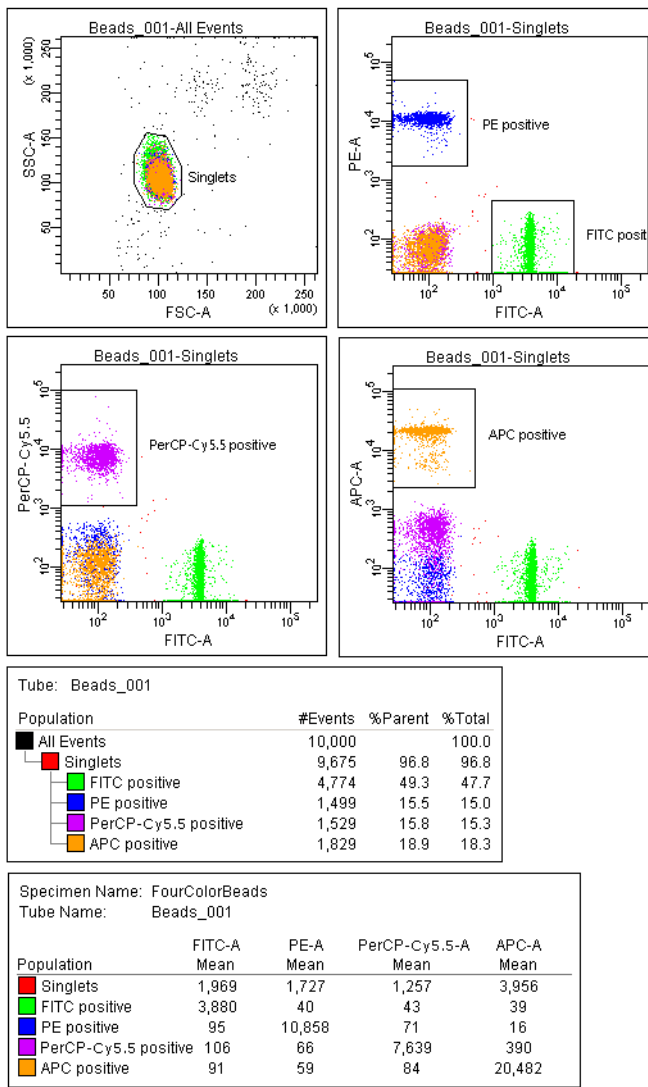

Reusing the Analysis

Global worksheets allow you to apply the same analysis to a series of recorded tubes. Once you define an analysis for a tube, you can use it to analyze the remaining tubes in the experiment. After viewing the data, print the analysis or save it to a tube-specific worksheet (see Saving the Analysis).

To reuse the analysis:

- 1 Set the current tube pointer to the tube Beads_002.
- 2 View the Beads_002 data on your analysis worksheet. Adjust the gates as needed.
 Tip Adjustments apply to subsequent tubes viewed on the worksheet. Avoid altering a global worksheet by saving an analysis to a tube-specific worksheet, then making adjustments on the tube-specific worksheet.
- 3 Print the analysis.

Saving the Analysis

When you perform analysis with a global worksheet, the analysis does not save with the tube.

- Tip** If you define your analysis on a global worksheet before recording data, you can specify to automatically save the analysis after recording data. You set this option in User Preferences.

To save a copy of the analysis of Beads_001 with that tube:

- 1 Expand the MyDataAnalysis global worksheet icon in the Browser.
- 2 Right-click its analysis and select Copy.

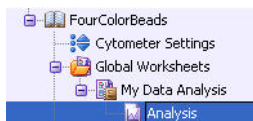

- 3 Click the Worksheets View button () on the Worksheet toolbar to switch to the normal worksheet view.
- 4 Select Worksheet > New Worksheet to create a new normal worksheet.
- 5 Right-click the Beads_001 tube icon in the Browser, and select Paste.

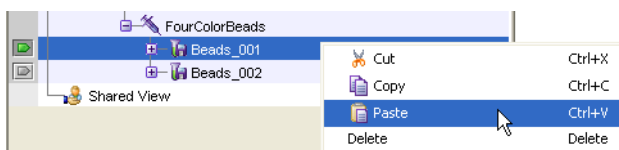

The analysis objects from the MyDataAnalysis global worksheet are copied to the Beads_001_Analysis normal worksheet. Double-click the Beads_001 tube in the Browser to view the analysis.

- Tip** Apply the global worksheet analysis to multiple tubes (on a single normal worksheet) by selecting more than one tube before you paste the analysis. Ensure that you collapse all tube elements in the Browser before you paste them to multiple tubes.

4

Maintenance

- Maintaining the Cytometer on page 78
- Daily Cleaning and Shutdown on page 78
- Scheduled Maintenance on page 80
- Periodic Maintenance on page 85

Maintaining the Cytometer

The BD LSR II cytometer is designed to require minimum maintenance. However, to preserve the reliability of the cytometer, you must regularly perform basic preventive maintenance procedures. This chapter explains routine cleaning procedures that keep your cytometer in good condition.



All biological specimens and materials coming into contact with them are considered biohazardous. Handle as if capable of transmitting infection. Dispose of waste using proper precautions and in accordance with local regulations. Never pipette by mouth. Wear suitable protective clothing, eyewear, and gloves.

- Tip** A 5% solution of sodium hypochlorite can be substituted for undiluted bleach in the following cleaning procedures. However, higher concentrations of sodium hypochlorite and use of other cleaning agents might damage the cytometer.

Daily Cleaning and Shutdown

Perform the following maintenance procedures every day:

- Daily Fluidics Cleaning on page 78
- Daily Shutdown on page 80

Daily Fluidics Cleaning

Each time you shut down the cytometer, clean the sample injection tube and the area between the injection tube and the outer sleeve. This prevents the sample injection tube from becoming clogged and removes dyes that can remain in the tubing.

- Tip** Follow this procedure immediately after running viscous samples or nucleic acid dyes such as Hoechst, DAPI, propidium iodide (PI), acridine orange (AO), or thiazole orange (TO).

To clean the fluidics:

- 1** Press RUN and HI on the cytometer fluid control panel.
- 2** Install a tube containing 3 mL of a bleach solution on the SIP with the support arm to the side (vacuum on) and let it run for 1 minute.

- Tip** For the bleach solution, use BD™ FACSClean solution or a 1:10 dilution of bleach in DI water.

BD FACS cleaning solution is a bleach-based cleaning agent designed for daily use in cytometer maintenance.

- 3** Move the tube support arm under the tube (vacuum off) and allow the bleach solution to run for 5 minutes with the sample flow rate set to HI.

- 4** Repeat steps 2 and 3 with BD™ FACSRinse solution.

BD FACSRinse solution is a detergent-based cleaning solution.

- 5** Repeat steps 2 and 3 with DI water.
- 6** Press the STNDBY button on the fluidics control panel.

- 7** Place a tube containing no more than 1 mL of DI water on the SIP.

A tube with 1 mL of DI water should remain on the SIP to prevent salt deposits from forming in the injection tube. This tube also catches back drips from the flow cell.

- Tip** Do not leave more than 1 mL of water on the SIP. When the BD LSR II flow cytometer is turned off or left in STNDBY mode, a small amount of fluid will drip back into the sample tube. If there is too much fluid in the tube, it could overflow and affect cytometer performance.

Daily Shutdown

To shut down the cytometer:

- 1 Turn off the flow cytometer.
- 2 Select Start > Shutdown to turn off the computer (if needed).

Tip If the cytometer will not be used for a week or longer, perform a system flush (see System Flush on page 80) and leave the fluidics system filled with DI water to prevent saline crystals from clogging the fluidics.

Scheduled Maintenance

Perform the following maintenance procedures every 2 weeks:

- System Flush on this page
- Waste Management System Maintenance on page 82

System Flush

An overall fluidics cleaning is required to remove debris and contaminants from the sheath tubing, waste tubing, and flow cell. Perform the system flush at least every 2 weeks.



Cytometer hardware might be contaminated with biohazardous material. Use 10% bleach to decontaminate the BD LSR II flow cytometer. Flushing with 10% bleach is the only procedure recommended by BD Biosciences for decontaminating the cytometer.

To perform a system flush:

- 1** Remove the sheath filter.
 - Press the quick-disconnects on both sides of the filter assembly.
 - Remove the filter assembly.
 - Connect the two fluid lines.
- Tip** Do not run detergent, bleach, or ethanol through the sheath filter. They can break down the filter paper within the filter body, causing particles to escape into the sheath fluid, possibly clogging the flow cell.
- 2** Empty the sheath container and rinse it with DI water.
- 3** Fill the sheath container with at least 1 L of a 1:10 dilution of bleach or full-strength BD FACS cleaning solution.
- 4** Empty the waste container, if needed.
- 5** Open the roller clamp by the fluidics interconnect, and drain the fluid into a beaker for 5 seconds.
- 6** Remove the DI water tube from the SIP.
- 7** Prime twice (perform the following twice):
 - Press the PRIME button on the fluidics control panel.
 - When the STNDBY button lights (amber), press the PRIME button again.
- 8** Install a tube with 3 mL of a 1:10 dilution of bleach or full-strength BD FACS cleaning solution on the SIP.
- 9** Press RUN and HI on the cytometer fluid control panel. Run for 30 minutes.

- 10** Press the STNDBY fluid control button and depressurize the sheath container by lifting the vent valve.
- 11** Repeat steps 2 through 10 with BD FACSRinse solution in place of the bleach solution.
- 12** Repeat steps 2 through 10 with DI water in place of the BD FACSRinse solution.
- 13** Replace the sheath filter and refill the sheath container with sheath fluid.

Waste Management System Maintenance

The waste management system for the BD LSR II cytometer has an alarm powered by a 9-volt battery that you must test and change regularly to ensure continued operation. Test the battery every 2 weeks after you flush the system. Change the battery as needed. See Changing the Battery on page 83 for more information.

Testing the Battery and Alarm

To test the battery and alarm:

- 1** Locate the Battery Test switch on the waste container bracket.

Figure 4-1 Battery Test switch



- 2** Toggle the switch.

If the battery and the alarm are working properly, you should hear buzzing. If you do not hear any sound, change the battery as described in the following section.

- 3** Release the switch.

Changing the Battery

You need the following supplies to change the battery:

- small flat-head screwdriver
- 9-volt battery

To change the battery:

- 1 Insert the tip of a flat-head screwdriver into the slot and gently slide the battery drawer out.

Figure 4-2 Battery drawer

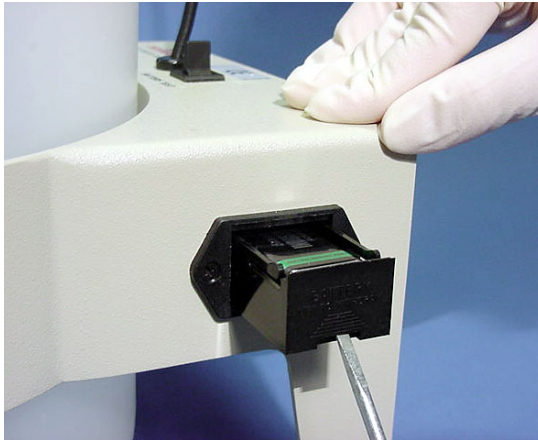

- 2 Remove the drawer.
- 3 Remove the battery from the drawer.



- 4 Place a new 9-volt battery into the drawer. The markings in the battery drawer show the correct battery orientation.
- 5 Slide the drawer into the bracket until you feel a click.
- 6 Test the new battery.

See Testing the Battery and Alarm on page 82.

Periodic Maintenance

You should check the following cytometer components occasionally and clean them as necessary. The frequency depends on how often you run the cytometer. You should check other components periodically for wear and replace if necessary.

- Changing the Sheath Filter on page 85
- Changing the Bal Seal on page 88
- Changing the Sample Tube O-Ring on page 90

Changing the Sheath Filter

The sheath filter (Figure 4-3) is connected in-line with the sheath line. It filters the sheath fluid as it comes from the sheath container. Increased debris appearing in an FSC vs SSC plot can indicate that the sheath filter needs to be replaced. We recommend changing the sheath filter assembly every 3–6 months.

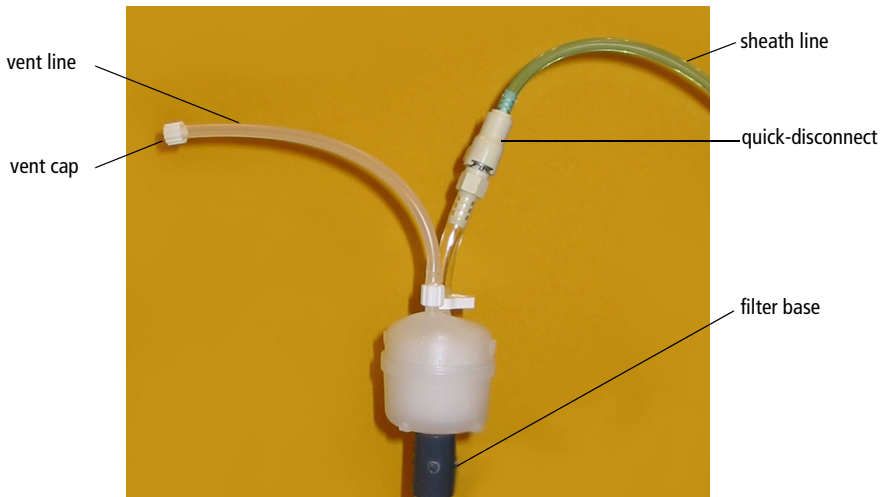

Figure 4-3 Sheath filter

Removing the Old Filter

To remove the old filter:

- 1** Place the cytometer in standby mode.
- 2** Remove the sheath filter assembly by pressing the quick-disconnect on both sides of the filter assembly.
- 3** Over a sink or beaker:
 - Remove the vent line from the filter and set it aside.
 - Remove the filter base and set it aside.
- 4** Discard the used filter assembly in an appropriate receptacle.

Attaching the New Filter

To attach the new filter:

- 1** Connect the vent line to the new filter assembly.
Twist to attach.
- 2** Connect the filter base to the filter.
- Tip** Wrap Teflon® tape around the filter threads before connecting the filter to the base.
- 3** Connect the sheath line to the filter assembly by squeezing the quick-disconnect.
- 4** Attach the cytometer fluid line to the filter assembly via the quick-disconnect.
- 5** Loosen the filter's vent cap to bleed off any air in the sheath filter.
- 6** Carefully tap the filter assembly to dislodge any air trapped in the filter element.
- 7** Repeat steps 5 and 6 as necessary to remove all trapped air.

Changing the Bal Seal

The sample injection tube Bal seal is a ring that forms a seal with the sample tube and ensures proper tube pressurization. Over time, the Bal seal becomes worn or cracked and requires replacement. Replacement is necessary if a proper seal is not formed when a sample tube is installed on the SIP.

☑ **Tip** Indications that a proper seal has not formed include:

- The tube will not stay on the SIP without the tube support arm.
- The tube is installed, RUN is pressed on the cytometer, and the RUN button is orange (not green).

To replace the Bal seal:

- 1** Remove the outer sleeve from the sample injection tube by turning the retainer counterclockwise.

Figure 4-4 Removing the outer sleeve

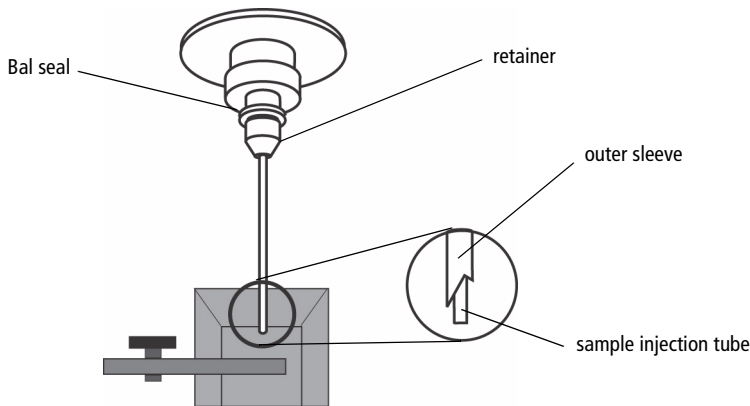

NOTICE Work carefully—the outer sleeve can fall out as you loosen the retainer.

- 2** Remove the Bal seal by gripping it between your thumb and index finger and pulling down.

Figure 4-5 Removing the Bal seal

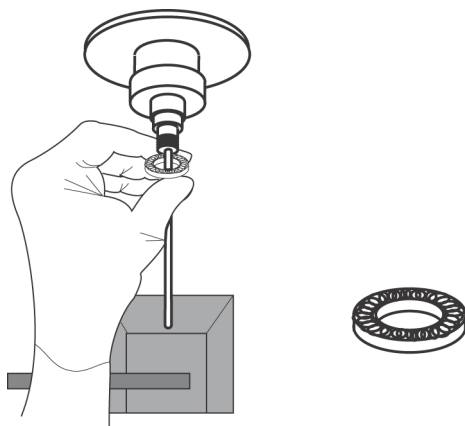

- 3** Install the new Bal seal spring-side up.
Gently push the seal in place to seat it.
- 4** Re-install the retainer and outer sleeve over the sample injection tube. Tighten the retainer just enough to hold it in place.
- 5** Install a sample tube on the SIP to ensure that the outer sleeve has been properly installed. If the sleeve hits the bottom of the tube, loosen the retainer slightly and push the sleeve up as far as it will go. Tighten the retainer.

Changing the Sample Tube O-Ring

The sample tube O-ring, located within the retainer, forms a seal that allows the droplet containment vacuum to function properly. Replace the O-ring when droplets form at the end of the sample injection tube while the vacuum is operating.



Cytometer hardware might be contaminated with biohazardous material. Wear suitable protective clothing, eyewear, and gloves whenever cleaning the cytometer or replacing parts.

To change the O-ring:

- 1** Remove the outer droplet sleeve from the sample injection tube by turning the retainer counterclockwise.
- 2** Pull the outer sleeve from the retainer.
- 3** Invert the retainer and allow the O-ring to fall onto the benchtop. If the O-ring does not fall out initially, tap the retainer on the benchtop to dislodge the O-ring.
- 4** Place the new O-ring into the retainer. Make sure the O-ring is seated properly in the bottom of the retainer.
- 5** Replace the outer sleeve into the retainer.
- 6** Re-install the retainer and the outer sleeve.
- 7** Install a sample tube on the SIP to ensure that the outer sleeve has been properly installed. If the sleeve hits the bottom of the tube, loosen the retainer slightly and push the sleeve up as far as it will go. Tighten the retainer.

Appendix A

Technical Overview

This appendix contains a technical overview of the following topics:

- Fluidics on page 92
- Optics on page 93
- Electronics on page 102

Fluidics

The fluidics system in the BD LSR II flow cytometer is pressure driven—a built-in air pump provides a sheath pressure of 5.5 psi. After passing through the sheath filter, sheath fluid is introduced into the lower chamber of the quartz flow cell.

The sample to be analyzed arrives in a separate pressurized stream. When a sample tube is placed on the sample injection port (SIP), the sample is forced up and injected into the lower chamber of the flow cell by a slight overpressure relative to the sheath fluid. The conical shape of the lower chamber creates a laminar sheath flow that carries the sample core upward through the center of the flow cell, where the particles to be measured are intercepted by the laser beam (Figure A-1 on page 93). This process is known as hydrodynamic focusing.

The objective in flow cytometric analysis is to have at most one cell or particle moving through a laser beam at a given time. The difference in pressure between the sample stream and sheath fluid stream can be used to vary the diameter of the sample core. Increasing the sample pressure increases the core diameter and therefore the flow rate (Figure A-1 on page 93).

- A higher flow rate is generally used for qualitative measurements such as immunophenotyping. The data is less resolved but is acquired more quickly.
- A lower flow rate is generally used in applications where greater resolution and quantitative measurements are critical, such as DNA analysis.

Proper operation of fluidic components is critical for particles to intercept the laser beam properly. Always ensure that the fluidics system is free of air bubbles and debris, and is properly pressurized.

Figure A-1 Hydrodynamic focusing of the sample core through the flow cell

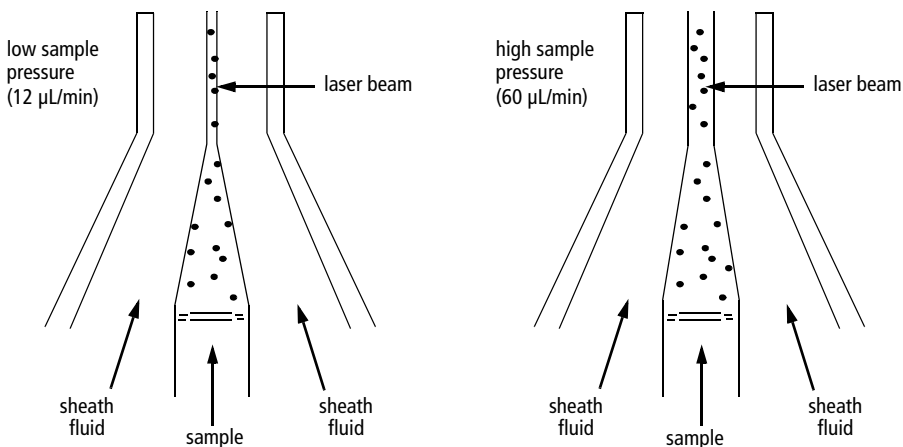

Optics

The optics system consists of lasers, optical filters, and detectors. Lasers illuminate the cells or particles in the sample and optical filters direct the resulting light scatter and fluorescence signals to the appropriate detectors.

Light Scatter

When a cell or particle passes through a focused laser beam, laser light is scattered in all directions (Figure A-2 on page 94). Light that scatters axial to the laser beam is called forward scatter (FSC); light that scatters perpendicular to the laser beam is called side scatter (SSC). FSC and SSC are related to certain physical properties of cells:

- FSC—indicates relative differences in the size of the cells or particles
- SSC—indicates relative differences in the internal complexity or granularity of the cells or particles

Figure A-2 Forward scatter (FSC) and side scatter (SSC)

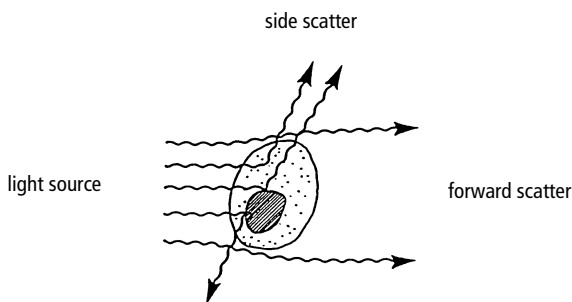

Fluorescence

When cells or particles stained with fluorochrome-conjugated antibodies or other dyes pass through a laser beam, the dyes can absorb photons (energy) and be promoted to an excited electronic state. In returning to their ground state, the dyes release energy, most of which is emitted as light. This light emission is known as fluorescence.

Fluorescence is always a longer wavelength (lower-energy photon) than the excitation wavelength. The difference between the excitation wavelength and the emission wavelength is known as the Stokes shift. Some fluorescent compounds such as PerCP exhibit a large Stokes shift, absorbing blue light (488 nm) and emitting red light (675 nm), while other fluorochromes such as FITC have a smaller Stokes shift, absorbing blue light and emitting green light (530 nm).

The emission spectra for some commonly used fluorochromes are shown in Figure A-3 on page 95.

Figure A-3 Emission spectra of commonly used fluorochromes

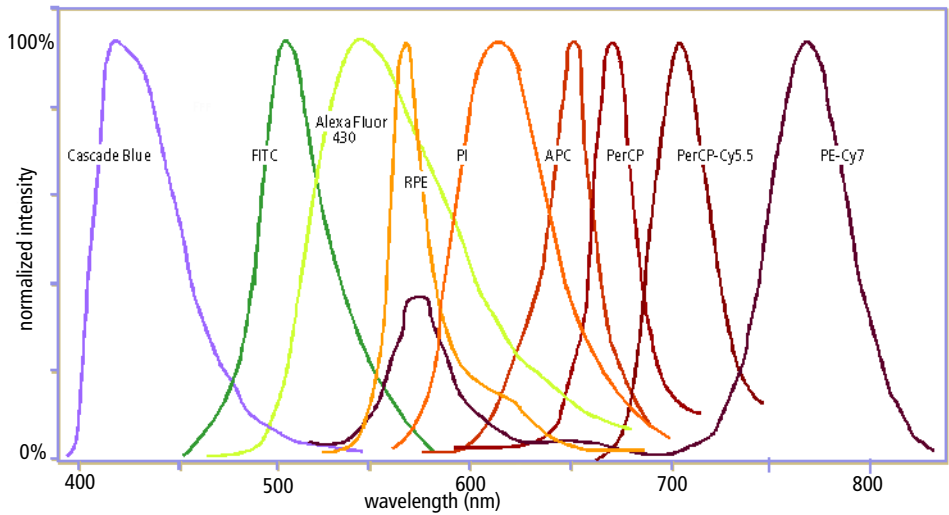

Optical Filters

Optical filters modify the spectral distribution of light scatter and fluorescence directed to the detectors. When photons encounter an optical filter, they are either transmitted, absorbed, or reflected (Figure A-4).

Figure A-4 Effect of an optical filter on incident photons

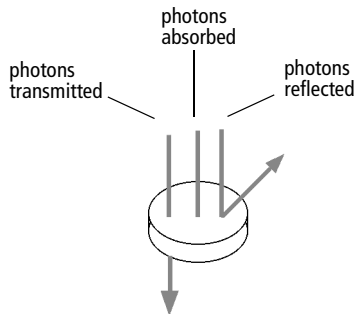

Even though an optical filter is rated at its 50% transmission point, the filter passes—or lets through—a minimal amount of light outside of this indicated rating.

The slope of an optical filter transmission curve indicates filter performance. A relatively steep slope indicates a high-performance, high-quality optical filter that provides deep attenuation of out-of-band wavelengths. A less steep slope indicates that more light outside the rated bandwidth is being transmitted.

Two kinds of filters are used on the BD LSR II flow cytometer:

- longpass (LP)
- bandpass (BP), including discriminating filters (DF) and ALPHA filters (AF)

A third filter type, the shortpass (SP), is not recommended, but can be used in some custom configurations. See Shortpass Filters on page 97.

LP, BP, and SP filters are referred to as dichroic filters. See Dichroic Mirrors on page 99.

Longpass Filters

LP filters pass wavelengths longer than the filter rating. For example, a 500-LP filter permits wavelengths longer than 500 nm to pass through it and either absorbs or reflects wavelengths shorter than 500 nm.

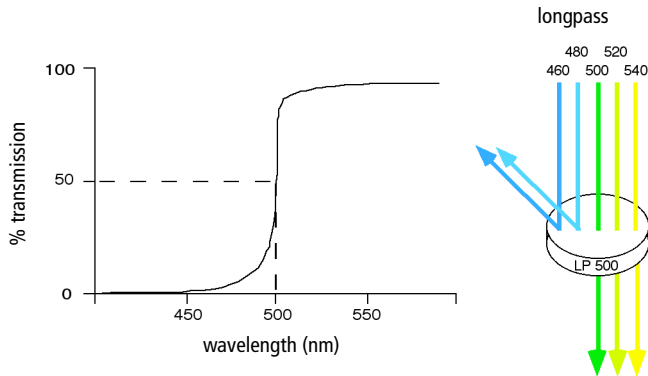

Shortpass Filters

An SP filter has the opposite properties of a longpass filter. An SP filter passes light with a shorter wavelength than the filter rating.

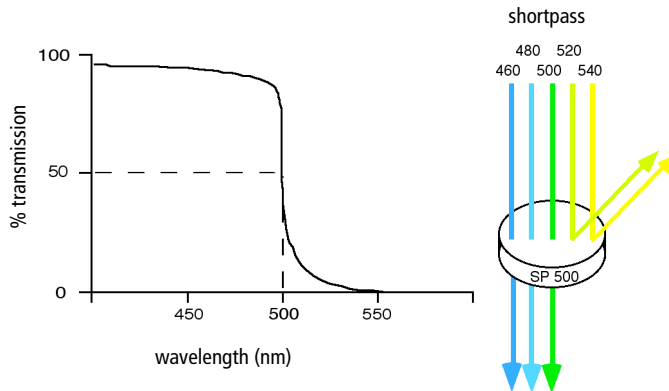

Bandpass Filters

A BP filter transmits a relatively narrow range or band of light. Bandpass filters are typically designated by two numbers. The first number indicates the center wavelength and the second refers to the width of the band of light that is passed. For example, a 500/50 BP filter transmits light that is centered at 500 nm and has

a total bandwidth of 50 nm. Therefore, this filter transmits light between 475 and 525 nm.

Figure A-5 Bandpass filter

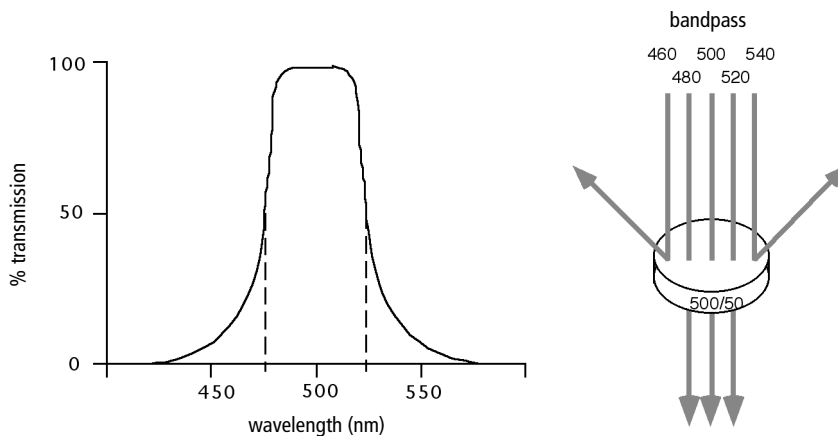

BP and DF filters have the same general function—they transmit a relatively narrow band of light. The principal difference between them is their construction. DF filters have more cavities or layers of optical coatings, resulting in a steeper transmission curve than the curve for a BP filter. This steep slope means that a DF filter is better at blocking light outside the rated bandwidth of the filter.

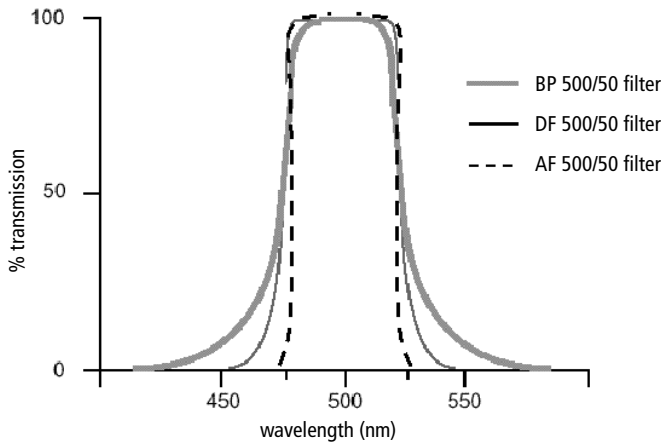

Dichroic Mirrors

Dichroic filters that are used to direct different color light signals to different detectors are called dichroic mirrors or beam splitters.

Although dichroic mirrors have the properties of LP or SP optical filters, you can not necessarily use any type of LP or SP filter as a beam splitter. A beam splitter must have a surface coating that reflects certain wavelengths, but many LP or SP filters are absorbance filters that do not have any specific reflective characteristics. Also, optical filters and beam splitters are rated at a specific angle of incidence. When used in front of the fluorescence detectors, they are perpendicular to the incident light, and when used as a beam splitter, they are placed at an angle relative to the light source. Their optical properties are therefore designed for that angle of incidence.

Compensation Theory

Fluorochromes emit light over a range of wavelengths (Figure A-3 on page 95). Optical filters are used to limit the range of frequencies measured by a given detector. However, when two or more fluorochromes are used, the overlap in wavelength ranges often makes it impossible for optical filters to isolate light from a given fluorochrome. As a result, light emitted from one fluorochrome

appears in a detector intended for another (Figure A-6). This is referred to as spillover. Spillover can be corrected mathematically by using a method called compensation.

Figure A-6 Spillover from the FITC fluorochrome to the PE detector

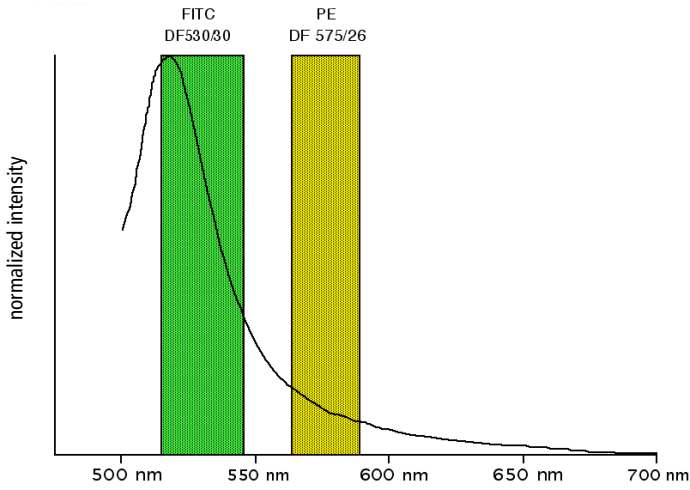

For example, FITC emission appears primarily in the FITC detector, but some of its fluorescence spills over into the PE detector. The spillover is corrected or compensated for—hence the term fluorescence compensation.

Figure A-6 shows that some of the FITC emission appears in the PE detector. This can be seen in a dot plot of FITC vs PE.

Figure A-7 Theoretical display of FITC vs PE without compensation

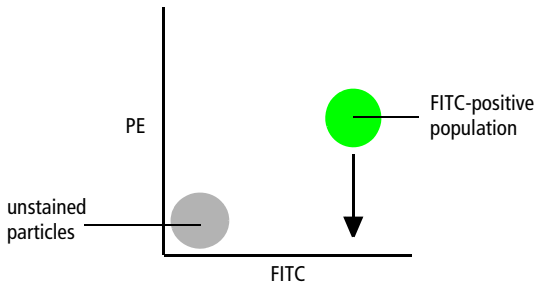

This FITC spillover in the PE detector is to be corrected as indicated by the arrow in Figure A-7. Using the Compensation tab of the Cytometer window in BD FACSDiva software, you can adjust the PE-%FITC spectral overlap value. Compensation is optimal when the positive and negative FITC populations have the same means or medians in the PE parameter statistics.

Figure A-8 FITC spillover optimally compensated out of the PE parameter

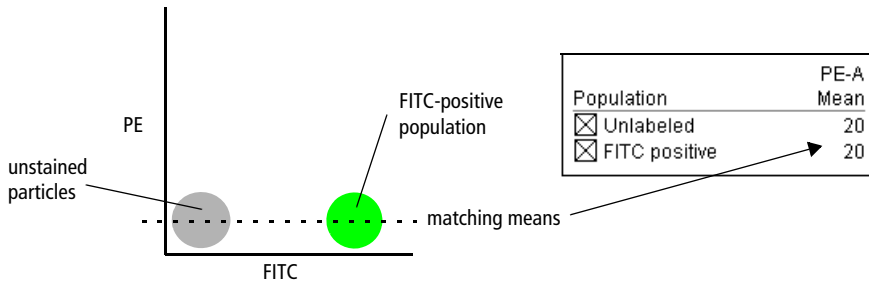

Once fluorescence compensation has been set for any sample, the compensation setting remains valid for a subsequent dim or bright sample, because compensation subtracts a percentage of the fluorescence intensity. Figure A-9 illustrates this principle. Although the signals differ in intensity, the percentage of the FITC spillover into the PE detector remains constant.

Figure A-9 Two FITC signals of different intensity

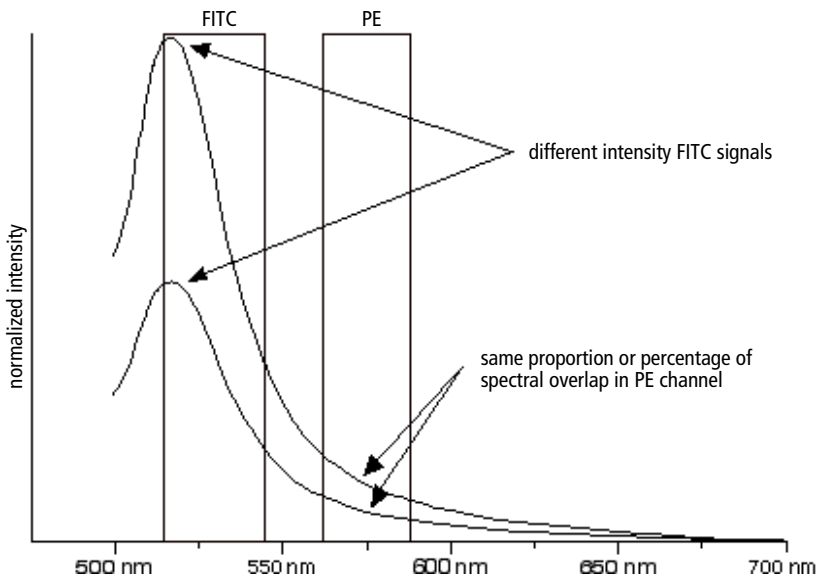

Electronics

As cells or other particles pass through a focused laser beam, they scatter the laser light and can emit fluorescence. Because the laser beam is focused on a small spot and particles move rapidly through the flow cell, the scatter or fluorescence emission has a very brief duration—only a few microseconds. This brief flash of light is converted into an electrical signal by the detectors. The electrical signal is called a pulse.

- 1** A pulse begins when a particle enters the laser beam. At this point, both the beam intensity and signal intensity are low.
- 2** The pulse reaches a maximum intensity or height when the particle reaches the middle of the beam, where the beam and signal intensity are the brightest. The peak intensity, or height of the pulse, is measured at this point.
- 3** As the particle leaves the beam, the pulse trails off below the threshold.

Figure A-10 Anatomy of a pulse

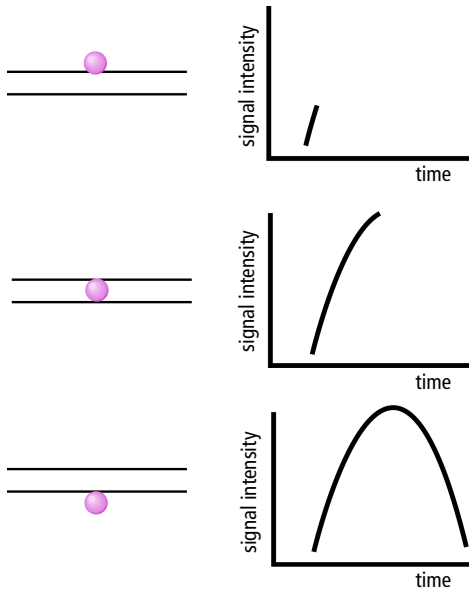

Pulse Measurements

The pulse processors measure pulses by three characteristics: height, area, and width.

Figure A-11 Pulse measurements

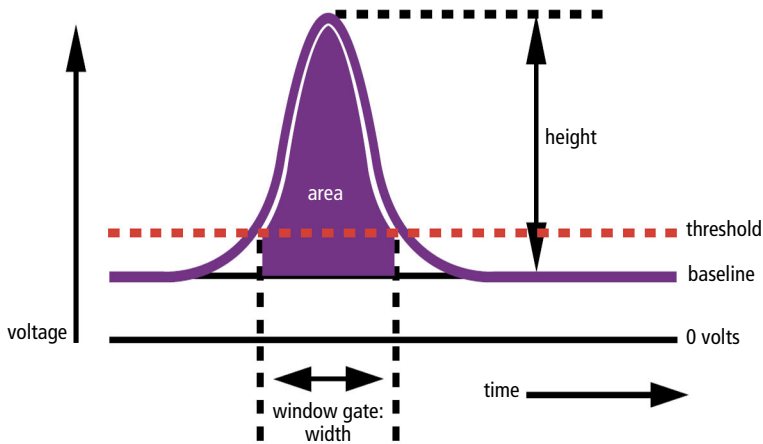

- Pulse height is the maximum digitized intensity measured for the pulse.
- Pulse area is an integration of the digitized measures over time.
- Pulse width calculates: $\frac{\text{area}}{\text{height}} \times 64,000$

Digital Electronics

BD LSR II flow cytometer electronics digitize the signal intensity produced by a detector. The digitized data is stored in memory and further processed by the electronics to calculate

- Pulse height, area, and width
- Compensation
- Parameter ratios

These results are transferred to your workstation computer for further processing by BD FACSDiva software. For more information about digital theory, refer to Digital Theory in the *BD FACSDiva Software Reference Manual*.

Threshold

The threshold is the level at which the system starts to measure signal pulses. A threshold is defined for a specific detector signal. The system continuously samples the digitized signal data and calculates pulse area, height, and width for all channels based on the time interval during which the threshold is exceeded.

Thresholds can also be set for more than one parameter, and pulse measures are based on either of the following:

- Intervals during which ALL signals exceed their threshold value
- Intervals during which ANY signal exceeds its threshold value

Laser Controls

Controls in the Laser tab of the Cytometer window are used to manually set the (laser) delay, area scaling, and window extension values.

These parameters are set by BD Biosciences service personnel during the BD LSR II flow cytometer installation and performance check and are updated each time you run a performance check.

If needed, see *Optimizing Laser Delay* on page 157 for instructions on manually adjusting laser delay settings. Do not otherwise change the settings in the Laser tab unless instructed to do so by BD Biosciences. Changing the settings affects your data.

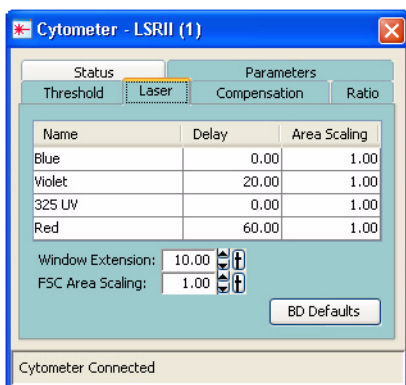

Appendix B

Troubleshooting

The tips in this section are designed to help you troubleshoot your experiments. You can find additional troubleshooting information in the *BD FACSDiva Software Reference Manual*.

If additional assistance is required, contact your local BD Biosciences technical support representative. See Technical Assistance on page xv.

Cytometer Troubleshooting

Observation	Possible Causes	Recommended Solutions
Droplet containment vacuum not functioning	Worn O-ring in retainer	Replace the O-ring. See Changing the Sample Tube O-Ring on page 90.
	Outer sleeve is not seated in the retainer	<ol style="list-style-type: none"> 1 Loosen the retainer (Figure 4-4 on page 88). 2 Push the outer sleeve up into the retainer until seated. 3 Tighten the retainer.
	Outer sleeve is not on the sample injection tube	<p>Replace the outer sleeve.</p> <ol style="list-style-type: none"> 1 Loosen the retainer. 2 Slide the outer sleeve over the sample injection tube until it is seated. 3 Tighten the retainer.
	Waste line is pinched, preventing proper aspiration	Check the waste line.
Sample tube not fitting on SIP	Waste tank is full	Empty the waste tank.
	Sample tube other than BD Falcon tubes used	Use BD Falcon 12 x 75-mm sample tubes. See Equipment on page 120.
Rapid sample aspiration	Worn Bal seal	Replace the Bal seal. See Changing the Bal Seal on page 88.
	Support arm is to the side	Place the support arm under the sample tube.
	Droplet containment module is failing	Call your service representative.

Cytometer Troubleshooting (continued)

Observation	Possible Causes	Recommended Solutions
No events in acquisition display and RUN button is green.	Threshold is not set to the correct parameter (usually FSC)	Set the threshold to the correct parameter for your application.
	Threshold level is too high	Lower the threshold level.
	PMT voltage for threshold parameter is set too low	Set the PMT voltage higher for the threshold parameter.
	Gating issue	Refer to the <i>BD FACSDiva Software Reference Manual</i> for information on setting gates.
	Air in the sheath filter	Purge the filter. See Removing Air Bubbles on page 49.
	No sample in the tube	Add sample to the tube or install a new sample tube.
	Sample is not mixed properly	Mix the sample to suspend cells.
	Waste tank is full	Empty the waste tank.
	PMT voltages set too low or too high for display parameter	Reset the PMT voltages.
	Too few events are displayed	Increase the number of events to display.
Sample injection tube is clogged		Remove the sample tube to allow backflushing.
		If the event rate is still erratic, clean the sample injection tube. See Daily Cleaning and Shutdown on page 78.
Bal seal is worn		Replace the Bal seal. See Changing the Bal Seal on page 88.

Cytometer Troubleshooting (continued)

Observation	Possible Causes	Recommended Solutions
No events in acquisition display and RUN button is green (continued)	Laser is not warmed up	Wait the recommended amount of time for the laser to warm up. <ul style="list-style-type: none">• 30 min for the 488-nm (blue)• 30 min for the 355-nm (UV)• 15 min for the 405-nm (violet)• 20 min for the 633-nm (red)
	Laser delay is set incorrectly	Adjust the laser delay settings. See Setting Laser Delay on page 155.
	Laser is not functioning	Verify the malfunction by changing the threshold to an alternative laser while running the appropriate sample. If unsuccessful, contact BD Biosciences.

Cytometer Troubleshooting (continued)

Observation	Possible Causes	Recommended Solutions
No events in acquisition display and RUN button is orange	RUN is not activated	Press the RUN button.
	Sample tube is not installed or is not properly seated	Install the sample tube correctly on the SIP.
	Sample tube is cracked	Replace the sample tube.
	Sheath container is not pressurized	<ul style="list-style-type: none"> • Ensure that the sheath container lid and all connectors are securely seated. • Inspect the O-ring and replace it if necessary. See Changing the Sample Tube O-Ring on page 90.
	Bal seal is worn	Replace the Bal seal. See Changing the Bal Seal on page 88.
No events in acquisition display and RUN button is orange (continued)	Air leak at sheath container	Ensure that the sheath container lid and all connectors are securely seated.
	Sheath container is empty	Fill the sheath container.
	Air in sheath filter	Purge the filter. See Removing Air Bubbles on page 49.

Cytometer Troubleshooting (continued)

Observation	Possible Causes	Recommended Solutions
No fluorescent signal	Incorrect fluorochrome assignment	Make sure the cytometer configuration in the software matches the optical filters in the cytometer.
	Wrong filter is installed	Make sure the appropriate filter is installed for each fluorochrome. See <i>Changing Optical Filters or Mirrors</i> on page 43.
	Laser is not functioning	Verify the laser malfunction by changing the threshold to an alternative laser while running the appropriate sample. If unsuccessful, contact BD Biosciences.
High event rate	Air bubble in the sheath filter or flow cell	Remove the air bubble. See <i>Removing Air Bubbles</i> on page 49.
	Threshold level is too low	Increase the threshold level. Refer to the <i>BD FACSDiva Software Reference Manual</i> for instructions.
	PMT voltage for the threshold parameter set too high	Set the PMT voltage lower for the threshold parameter. Refer to the <i>BD FACSDiva Software Reference Manual</i> for instructions.
	Sample is too concentrated	Dilute the sample.
	Sample flow rate is set on HI	Set the sample flow rate to MED or LO.

Cytometer Troubleshooting (continued)

Observation	Possible Causes	Recommended Solutions
Low event rate	Threshold level is too high	Lower the threshold level. Refer to the <i>BD FACSDiva Software Reference Manual</i> for instructions.
	PMT voltage for the threshold parameter is set too low	Set the PMT voltage higher for the threshold parameter. Refer to the <i>BD FACSDiva Software Reference Manual</i> for instructions.
	Sample is not adequately mixed	Mix the sample to suspend the cells.
	Sample is too diluted	Concentrate the sample. If the flow rate setting is not critical to the application, set the flow rate switch to MED or HI.
	Sample injection tube is clogged	Remove the sample tube to allow backflushing. If the event rate is still erratic, clean the sample injection tube. See Daily Cleaning and Shutdown on page 78.
Erratic event rate	Sample tube is cracked	Replace the sample tube.
	Bal seal is worn	Replace the Bal seal. See Changing the Bal Seal on page 88.
	Sample injection tube is clogged	Remove the sample tube to allow backflushing. If the event rate is still erratic, clean the sample injection tube. See Daily Cleaning and Shutdown on page 78.

Cytometer Troubleshooting (continued)

Observation	Possible Causes	Recommended Solutions
Erratic event rate (continued)	Sample injection tube is clogged	Remove the sample tube to allow backflushing. If the event rate is still erratic, clean the sample injection tube. See Daily Cleaning and Shutdown on page 78.
	Contaminated sample	Prepare the specimen again. Ensure that the tube is clean.
	Sheath filter is dirty	Replace the filter. See Changing the Sheath Filter on page 85.
Distorted scatter parameters	Cytometer settings are improperly adjusted	Optimize the scatter parameters. Refer to the <i>BD FACSDiva Software Reference Manual</i> for instructions.
	Air bubble in sheath filter or flow cell	Purge the air from the filter. See Removing Air Bubbles on page 49.
	Flow cell is dirty	Perform the system flush procedure. See System Flush on page 80.
	Air leak at sheath container	Ensure that the sheath container lid is tight and all connectors are secure.
	Hypertonic buffers or fixative	Replace the buffers and fixative.

Cytometer Troubleshooting (continued)

Observation	Possible Causes	Recommended Solutions
Excessive amount of debris in display	Threshold level is too low	Increase the threshold level.
	Sheath filter is dirty	Replace the filter. See Changing the Sheath Filter on page 85.
	Flow cell is dirty	Flush the system. See System Flush on page 80.
	Dead cells or debris in sample	Examine the sample under a microscope.
	Sample is contaminated	Re-stain the sample, ensure tube is clean.
	Stock sheath fluid is contaminated	Rinse the sheath container with DI water, then fill with sheath fluid from another (or new lot) bulk container.
High CV	Air bubble in sheath filter or flow cell	Purge the filter. See Removing Air Bubbles on page 49.
	Sample flow rate is set too high	Set the sample flow rate lower.
	Air leak at sheath container	Ensure that the sheath container lid is tight and all connectors are secure.
	Flow cell is dirty	Flush the system. See System Flush on page 80.
	Poor sample preparation	Repeat sample preparation.
	Sample not diluted in same fluid as sheath fluid	Dilute the sample in the same fluid as you are using for sheath.

Cytometer Troubleshooting (continued)

Observation	Possible Causes	Recommended Solutions
Poor QC results	Air bubble or debris in flow cell	Prime the fluidics system. See Priming the Fluidics on page 50.
	Old or contaminated QC particles	Make new QC samples and perform the quality control procedure again.
	Sample not diluted in same fluid as sheath fluid	Dilute the sample in the same fluid as you are using for sheath.
	Laser not warmed up	Wait the recommended amount of time for the laser to warm up. <ul style="list-style-type: none">• 30 min for the 488-nm (blue)• 30 min for the 355-nm (UV)• 15 min for the 405-nm (violet)• 20 min for the 633-nm (red)
	Laser not functioning	Contact BD Biosciences.
	Optical alignment problem	Contact BD Biosciences.

Appendix C

Supplies and Consumables

To order spare parts and consumables, such as bulk fluids, from BD Biosciences:

- Within the US, call (877) 232-8995.
- Outside the US, contact your local BD Biosciences customer support representative.

Worldwide contact information can be found at bdbiosciences.com.

Use the following part numbers to order supplies for your BD LSR II system:

- QC Particles on page 118
- QC Cytometer Setup and Tracking Particles on page 118
- Reagents on page 119
- Equipment on page 120

QC Particles

Particle	Laser	Supplier	Catalog No.
<ul style="list-style-type: none"> • SPHERO™ Rainbow Calibration Particles (8 peak) • SPHERO Ultra Rainbow Fluorescent Particles (single peak) 	<ul style="list-style-type: none"> • all • all 	<ul style="list-style-type: none"> • BD Biosciences • Spherotech, Inc. 	<ul style="list-style-type: none"> • 559123 • URFP-30-2
DNA QC Particles kit	blue 488 nm	BD Biosciences	349523

QC Cytometer Setup and Tracking Particles

Particle	Laser	Supplier
BD Cytometer Setup and Tracking beads	<ul style="list-style-type: none"> • UV (355 nm and 375 nm) • violet (405 nm and 407 nm) • blue (488 nm) • green (532 nm) • red (633 nm and 645 nm) 	BD Biosciences (contact BD Biosciences for more information)

Reagents

Reagent	Supplier	Catalog No.
BD FACST ^{Flow} sheath fluid	BD Biosciences	340398 (US and Latin America) 342003 (Europe)
Monoclonal antibodies	BD Biosciences	— ^a
BD FACST ^M lysing solution	BD Biosciences	349202
BD FACSRinse solution	BD Biosciences	340346
BD FACSClean solution	BD Biosciences	340345
Dyes and fluorochromes	BD Biosciences Molecular Probes Sigma	—
Chlorine bleach (5% sodium hypochlorite)	Clorox or other major supplier (to ensure that the bleach is at the correct concentration and free of particulate matter)	—

a. Refer to the BD Biosciences Product Catalog or the BD Biosciences website (bdbiosciences.com).

Equipment

Equipment Item	Supplier	Catalog No.
Bal seal	BD Biosciences	343509
O-ring, sample tube		343615
Sheath filter assembly		344678
BD Falcon™ polystyrene test tubes, 12 x 75-mm		352052 352054 352058

Appendix D

Standard Base Configuration

The standard base configuration for a BD LSR II cytometer supports detectors, filters, and mirrors for one to four lasers. This appendix describes how to set up the cytometer optics using standard default configuration components.

- 4-Blue 2-Violet 2-355 UV 2-Red Configuration on page 122
- Additional Optics on page 128

The BD LSR II cytometer can also be ordered with one of several optional configurations, which are described in Appendix E.

4-Blue 2-Violet 2-355 UV 2-Red Configuration

The standard configuration supports a blue octagon, and violet, UV, and red trigons. Table D-1 shows the detectors, filters, and mirrors used in the standard default configuration, and recommended fluorochromes for each detector. The word “blank” indicates that a blank optical holder should be used instead of a mirror or filter. A dash (—) indicates that no slot exists for a mirror in that PMT position.

Table D-1 Default filters and fluorochromes

Detector Array (Laser)	PMT (Detector)	Longpass Dichroic Mirror	Bandpass Filter	Fluorochrome or Scatter Parameter
blue octagon (488-nm laser)	A	735 LP	780/60	PE-Cy7
	B	685 LP	695/40	PerCP-Cy5.5
	C	550 LP	575/26	PE, PI
	D	505 LP	530/30	FITC, GFP
	E	blank	488/10	SSC
	F	blank	blank	none
	G	blank	blank	none
	H	—	blank	none
violet trignon (405-nm laser)	A	505 LP	525/50	AmCyan
	B	blank	440/40	Pacific Blue™
	C	—	blank	none
UV trignon (355-nm laser)	A	505 LP	530/30	Indo-1 (Blue)
	B	blank	450/50	Indo-1 (Violet), DAPI
	C	—	blank	none

Table D-1 Default filters and fluorochromes (continued)

Detector Array (Laser)	PMT (Detector)	Longpass Dichroic Mirror	Bandpass Filter	Fluorochrome or Scatter Parameter
red trigon (633-nm laser)	A	735 LP	780/60	APC-Cy7
	B	blank	660/20	APC
	C	—	blank	none

Base Configuration

Figure D-1 shows a default base cytometer configuration.

Figure D-1 Base configuration

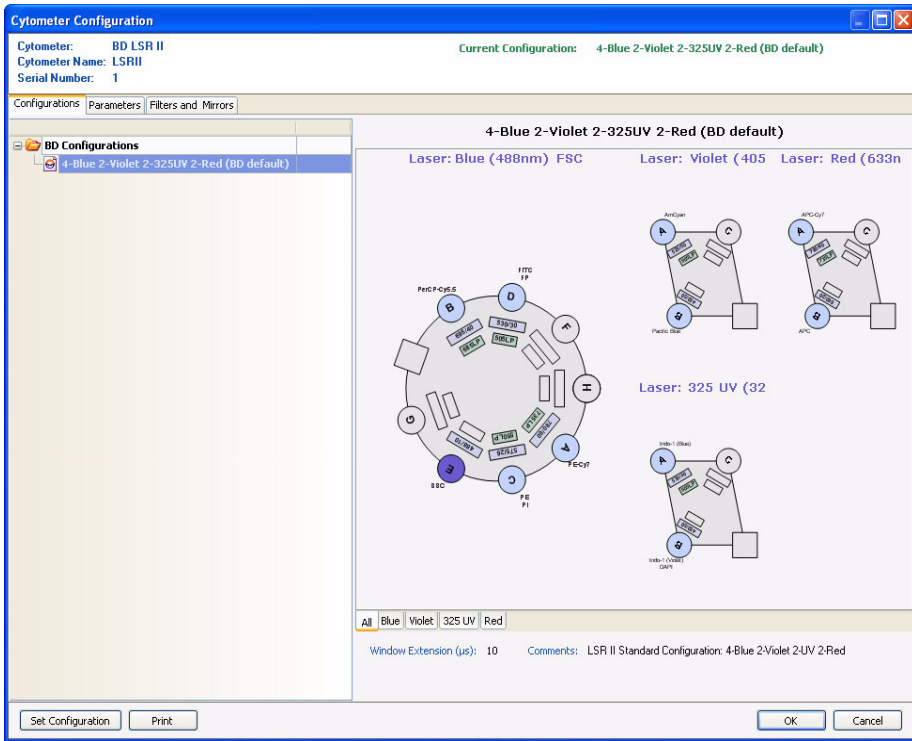

Octagon and Trigon Maps

This section shows how to install mirrors and filters in your octagon and trigons for the standard default configuration.

If a slot is filled with a filter or mirror, an identifying number appears in that position on the configuration map. If a slot is filled with a blank optical holder, that position on the configuration map is unlabeled.

Figure D-2 Standard default configuration: blue octagon

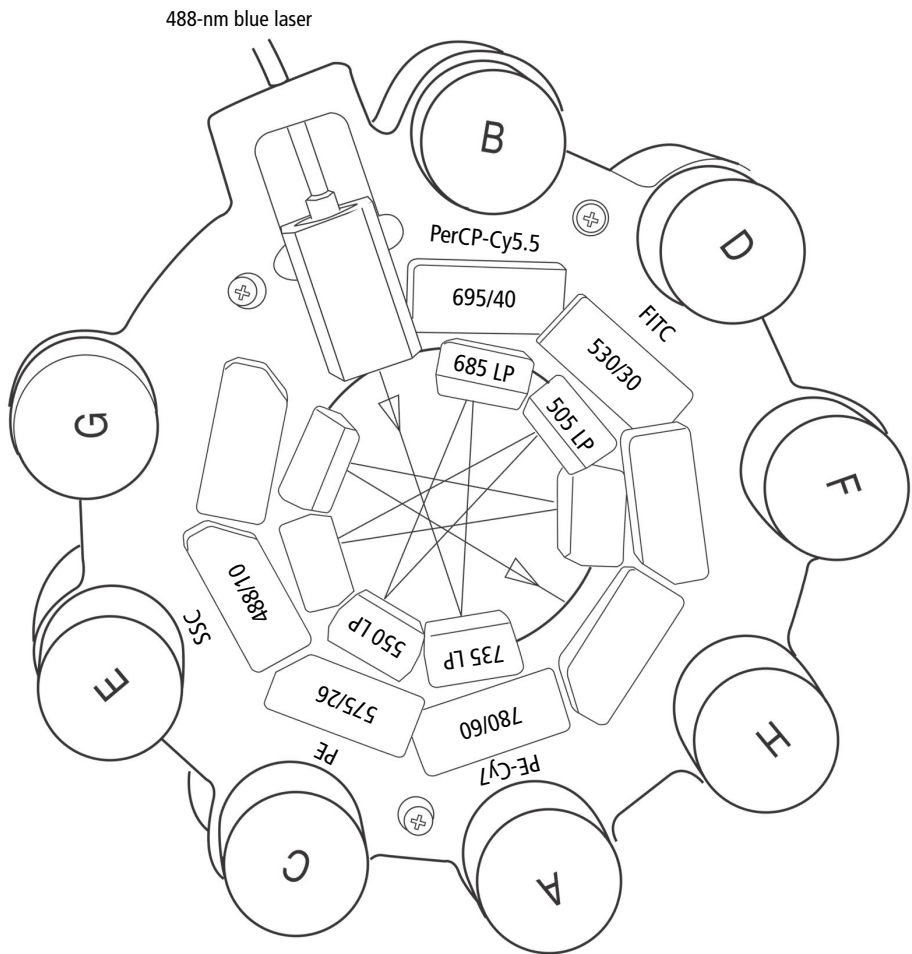
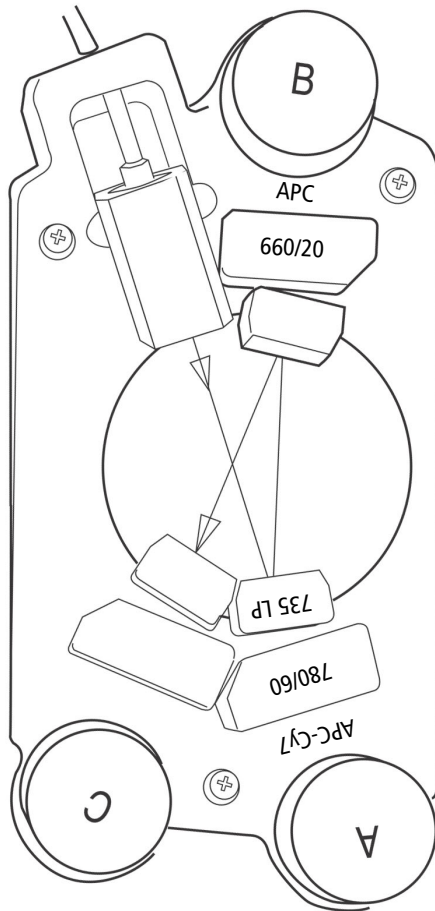

Figure D-3 Standard default configuration: red and violet trigons

633-nm red laser



405-nm violet laser

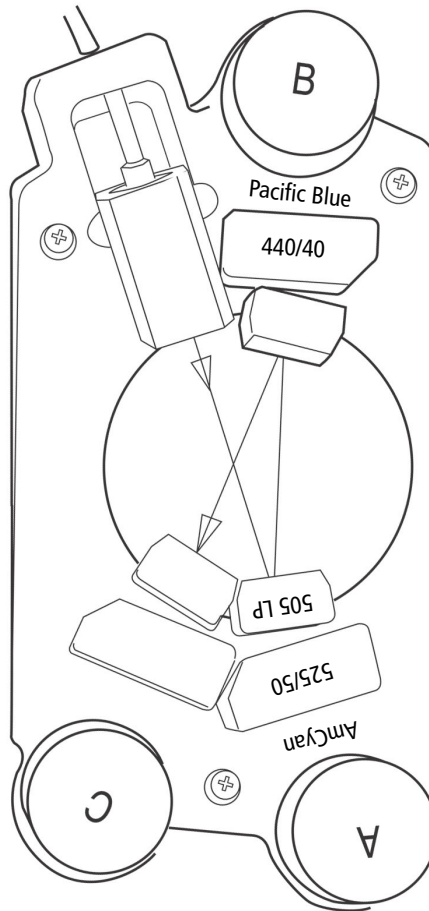
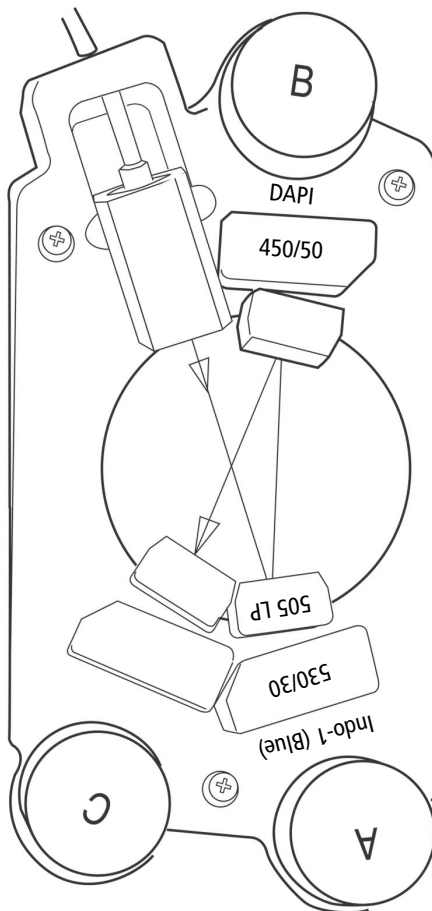

Figure D-4 Standard default configuration: UV trigon

355-nm UV laser



Additional Optics

This section describes some common custom filter and mirror configurations. Table D-2 shows the detector arrays, mirrors, and filters used in the custom configurations, and recommended fluorochromes for each detector. The mirrors and filters used in these custom configurations are contained in the BD LSR II cytometer spares kit.

Table D-2 Additional filters and mirrors

Detector Array (Laser)	Mirror	Filter	Fluorochrome
blue octagon standard 488-nm blue laser	600 LP	610/20	PE-Texas Red™
	635 LP	670/14	PerCP BD Cy-Chrome™ reagent
		585/42	DsRed
violet trigon optional 405-nm violet laser	none	none	none
UV trigon optional 355-nm UV laser	450 LP		Indo-1 (Blue)
		405/20	Indo-1 (Violet)
red trigon optional 633-nm red laser	none	none	none

Maps on the following pages show how to install mirrors and filters in your octagon and trigons for common custom configurations.

PE-Texas Red™

To use PE-Texas Red™, replace the mirror and filter for the B PMT of the blue octagon as shown below.

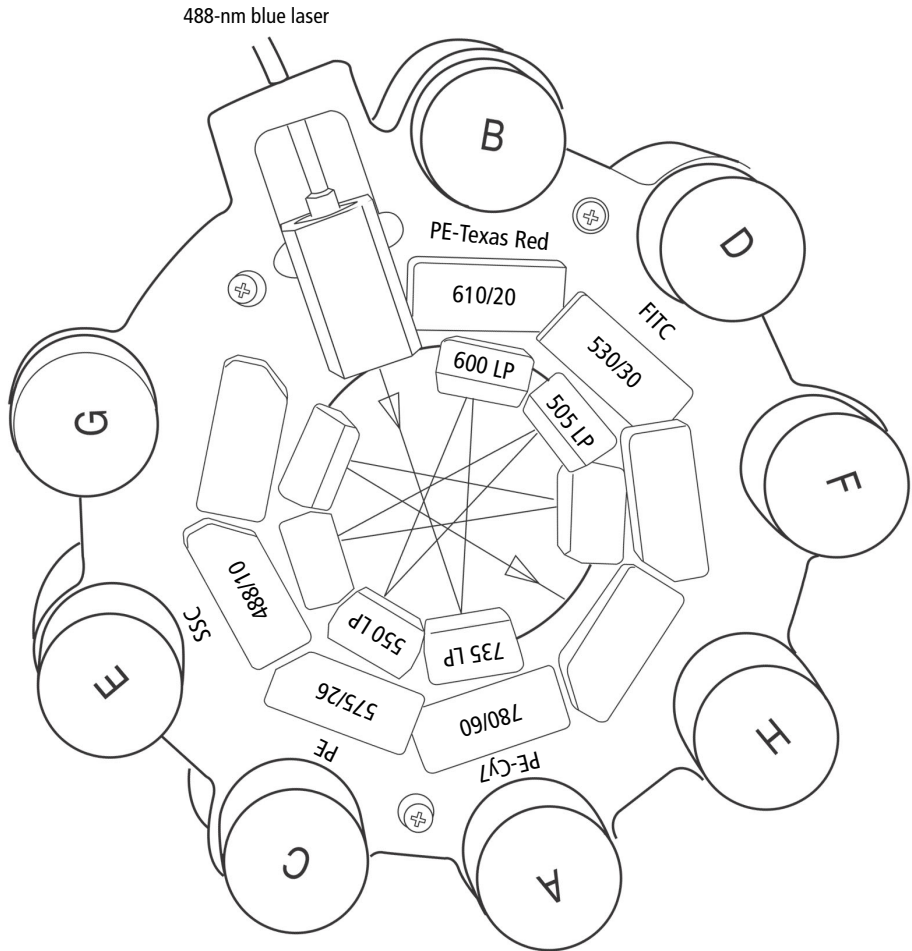

Indo-1

If you have a violet laser, replace the mirror for the A PMT of the UV trigon as shown on the left below.

If you do not have a violet laser, replace both the mirror for the A PMT and the filter for the B PMT of the UV trigon as shown on the right below.

355-nm UV laser
(with violet laser)

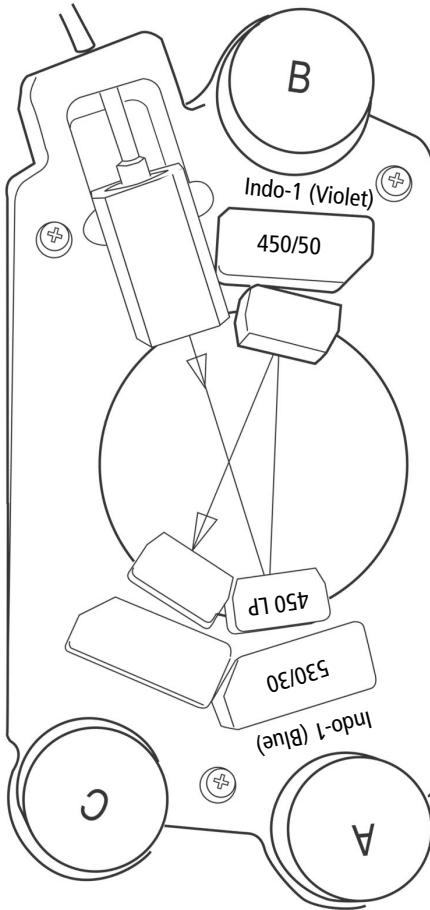

355-nm UV laser
(no violet laser)

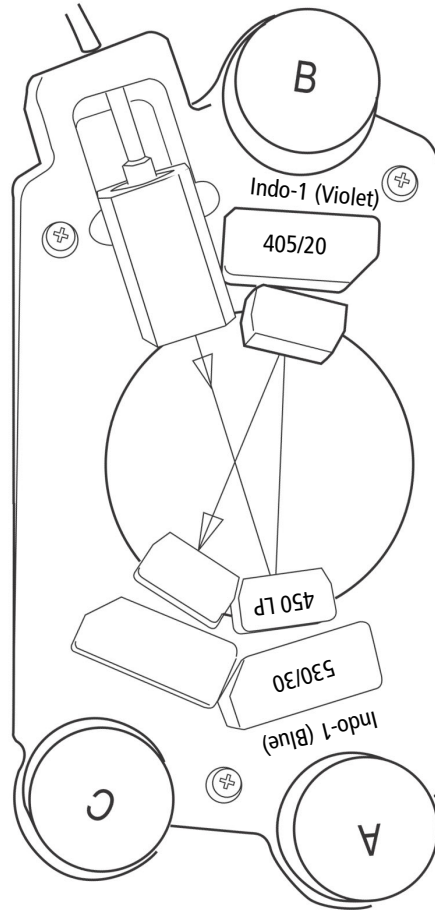

DsRed

To use DsRed, replace the filter for the C PMT of the blue octagon as shown below.

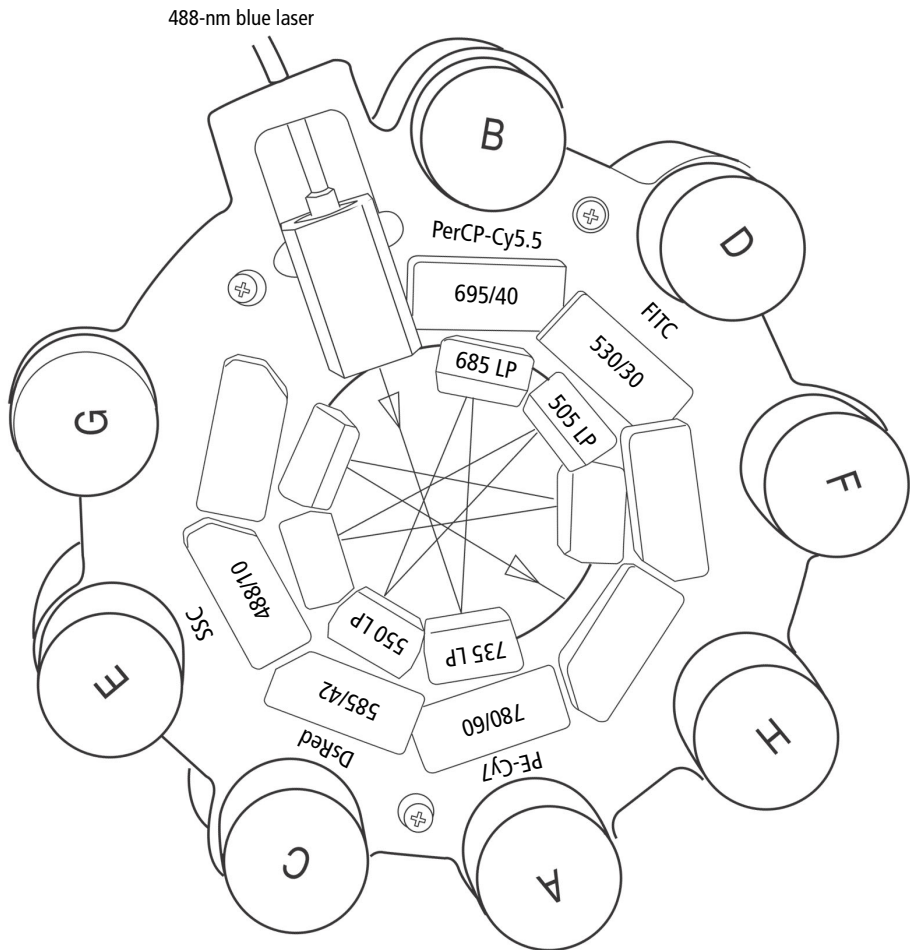

PerCP or BD Cy-Chrome Reagent

To use PerCP or BD Cy-Chrome reagent, replace the mirror and filter for the B PMT of the blue octagon as shown below.

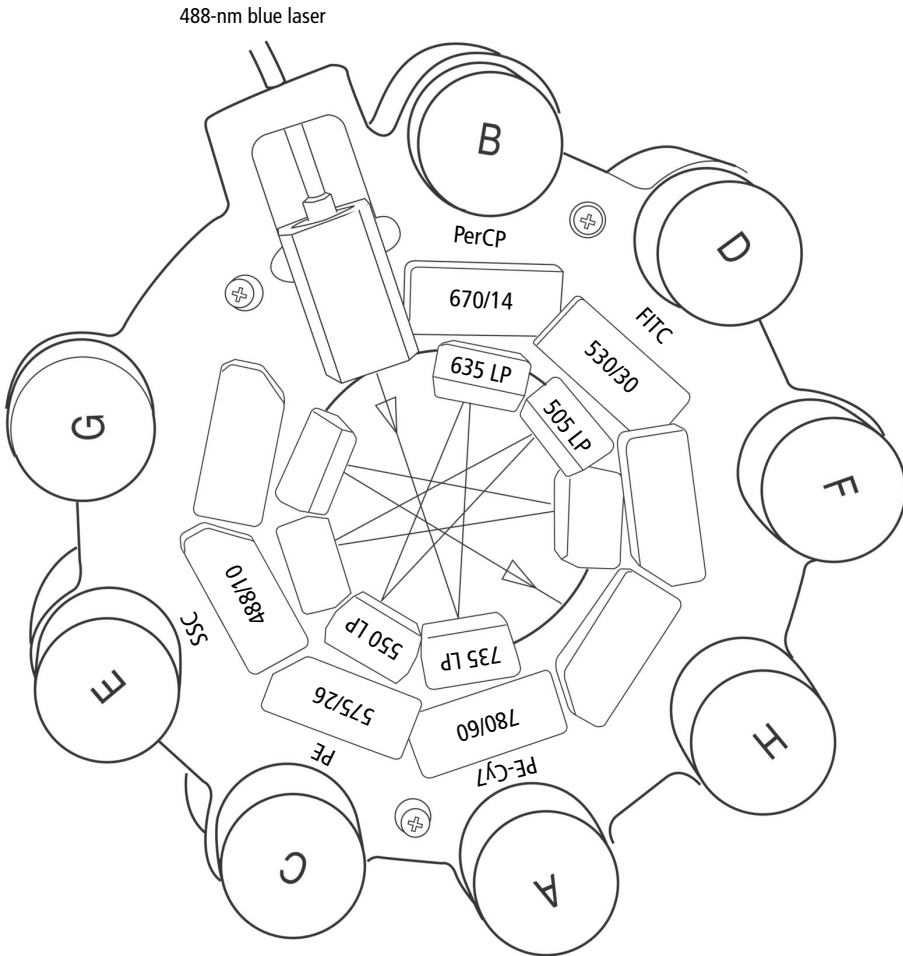

Appendix E

Special Order Configurations

The BD LSR II cytometer can be ordered with, or upgraded to, one of several laser and detector array options. You must use the Cytometer Setup and Tracking application to set up new configurations. See the *Cytometer Setup and Tracking Applications Guide* for more information.

This appendix contains the following information:

- Common Special Order Configurations on page 134
- Special Order Configuration Trigon and Octagon Maps on page 148

Common Special Order Configurations

The following are commonly used configurations.

- 6-Blue 0-Violet 0-UV 3-Red Configuration on page 135
- 6-Blue 2-Violet 0-UV 3-Red Configuration on page 136
- 6-Blue 0-Violet 2-UV 3-Red Configuration on page 137
- 6-Blue 2-Violet 2-UV 3-Red Configuration on page 139
- 6-Blue 6-Violet 0-UV 3-Red Configuration on page 140
- 6-Blue 6-Violet 0-UV 4-Red Configuration on page 142
- 6-Blue 6-Violet 2-UV 3-Red Configuration on page 144
- 6-Blue 6-Violet 2-UV 4-Red Configuration on page 146

6-Blue 0-Violet 0-UV 3-Red Configuration

6-Blue 0-Violet 0-UV 3-Red supports a blue octagon and a red trigon. Table E-1 shows the detectors, filters, and mirrors used in the default configuration. The word “blank” indicates that a blank optical holder should be used instead of a mirror or filter. A dash (—) indicates that no slot exists for a mirror in that PMT position.

The 6-Blue 0-Violet 0-UV 3-Red maps are:

- 6-Color Blue Octagon Default Configuration Map on page 149
- 3-Color Red Trigon Default Configuration Map on page 153

Table E-1 6-Blue 0-Violet 0-UV 3-Red default mirror and filter configuration

Detector Array (Laser)	PMT (Detector)	Longpass Dichroic Mirror	Bandpass Filter	Fluorochrome or Scatter Parameter
blue octagon (488-nm laser)	A	755 LP	780/60	PE-Cy7
	B	685 LP	695/40	PerCP-Cy5.5
	C	655 LP	660/20	PE-Cy5
	D	600 LP	610/20	PE-Texas Red™
	E	550 LP	575/26	PE
	F	505 LP	530/30	FITC, Alexa Fluor® 488
	G	blank	488/10	SSC
	H	—	blank	none
red trigon (633-nm laser)	A	755 LP	780/60	APC-Cy7
	B	710 LP	730/45	Alexa Fluor® 700
	C	—	660/20	APC

6-Blue 2-Violet 0-UV 3-Red Configuration

6-Blue 2-Violet 0-UV 3-Red supports a blue octagon, and violet and red trigons. Table E-2 shows the detectors, filters, and mirrors used in the default configuration. The word “blank” indicates that a blank optical holder should be used instead of a mirror or filter. A dash (—) indicates that no slot exists for a mirror in that PMT position.

The 6-Blue 2-Violet 0-UV 3-Red maps are:

- 6-Color Blue Octagon Default Configuration Map on page 149
- 2-Color Violet Trigon Default Configuration Map on page 150
- 3-Color Red Trigon Default Configuration Map on page 153

Table E-2 6-Blue 2-Violet 0-UV 3-Red default mirror and filter configuration

Detector Array (Laser)	PMT (Detector)	Longpass Dichroic Mirror	Bandpass Filter	Fluorochrome or Scatter Parameter
blue octagon (488-nm laser)	A	755 LP	780/60	PE-Cy7
	B	685 LP	695/40	PerCP-Cy5.5
	C	655 LP	660/20	PE-Cy5
	D	600 LP	610/20	PE-Texas Red™
	E	550 LP	575/26	PE
	F	505 LP	530/30	FITC, Alexa Fluor® 488
	G	blank	488/10	SSC
	H	—	blank	none

Table E-2 6-Blue 2-Violet 0-UV 3-Red default mirror and filter configuration (continued)

Detector Array (Laser)	PMT (Detector)	Longpass Dichroic Mirror	Bandpass Filter	Fluorochrome or Scatter Parameter
violet trigon (405-nm laser)	A	505 LP	525/50	AmCyan
	B	blank	450/50	Pacific Blue™
	C	—	blank	none
red trigon (633-nm laser)	A	755 LP	780/60	APC-Cy7
	B	710 LP	730/45	Alexa Fluor® 700
	C	—	660/20	APC

6-Blue 0-Violet 2-UV 3-Red Configuration

6-Blue 0-Violet 2-UV 3-Red supports a blue octagon, and UV and red trigons. Table E-3 on page 138 shows the detectors, filters, and mirrors used in the default configuration. The word “blank” indicates that a blank optical holder should be used instead of a mirror or filter. A dash (—) indicates that no slot exists for a mirror in that PMT position.

The 6-Blue 0-Violet 2-UV 3-Red maps are:

- 6-Color Blue Octagon Default Configuration Map on page 149
- 2-Color UV Trigon Default Configuration Map on page 152
- 3-Color Red Trigon Default Configuration Map on page 153

Table E-3 6-Blue 0-Violet 2-UV 3-Red default mirror and filter configuration

Detector Array (Laser)	PMT (Detector)	Longpass Dichroic Mirror	Bandpass Filter	Fluorochrome or Scatter Parameter
blue octagon (488-nm laser)	A	755 LP	780/60	PE-Cy7
	B	685 LP	695/40	PerCP-Cy5.5
	C	655 LP	660/20	PE-Cy5
	D	600 LP	610/20	PE-Texas Red™
	E	550 LP	575/26	PE
	F	505 LP	530/30	FITC, Alexa Fluor® 488
	G	blank	488/10	SSC
	H	—	blank	none
UV trigon (355-nm laser)	A	505 LP	530/30	Indo-1 (Blue)
	B	blank	450/50	Indo-1 (Violet), DAPI
	C	—	blank	none
red trigon (633-nm laser)	A	755 LP	780/60	APC-Cy7
	B	710 LP	730/45	Alexa Fluor® 700
	C	—	660/20	APC

6-Blue 2-Violet 2-UV 3-Red Configuration

6-Blue 2-Violet 2-UV 3-Red supports a blue octagon, and violet, UV, and red trigons. Table E-4 shows the detectors, filters, and mirrors used in the default configuration. The word “blank” indicates that a blank optical holder should be used instead of a mirror or filter. A dash (—) indicates that no slot exists for a mirror in that PMT position.

The 6-Blue 2-Violet 2-UV 3-Red maps are:

- 6-Color Blue Octagon Default Configuration Map on page 149
- 2-Color Violet Trigon Default Configuration Map on page 150
- 2-Color UV Trigon Default Configuration Map on page 152
- 3-Color Red Trigon Default Configuration Map on page 153

Table E-4 6-Blue 2-Violet 2-UV 3-Red default mirror and filter configuration

Detector Array (Laser)	PMT (Detector)	Longpass Dichroic Mirror	Bandpass Filter	Fluorochrome or Scatter Parameter
blue octagon (488-nm laser)	A	755 LP	780/60	PE-Cy7
	B	685 LP	695/40	PerCP-Cy5.5
	C	655 LP	660/20	PE-Cy5
	D	600 LP	610/20	PE-Texas Red™
	E	550 LP	575/26	PE
	F	505 LP	530/30	FITC, Alexa Fluor® 488
	G	blank	488/10	SSC
	H	—	blank	none

Table E-4 6-Blue 2-Violet 2-UV 3-Red default mirror and filter configuration (continued)

Detector Array (Laser)	PMT (Detector)	Longpass Dichroic Mirror	Bandpass Filter	Fluorochrome or Scatter Parameter
violet trigon (405-nm laser)	A	505 LP	525/50	AmCyan
	B	blank	450/50	Pacific Blue™
	C	—	blank	none
UV trigon (355-nm laser)	A	505 LP	530/30	Indo-1 (Blue)
	B	blank	450/50	Indo-1 (Violet), DAPI
	C	—	blank	none
red trigon (633-nm laser)	A	755 LP	780/60	APC-Cy7
	B	710 LP	730/45	Alexa Fluor® 700
	C	—	660/20	APC

6-Blue 6-Violet 0-UV 3-Red Configuration

6-Blue 6-Violet 0-UV 3-Red supports blue violet octagons, and a red trigon. Table E-5 on page 141 shows the detectors, filters, and mirrors used in the default configuration. The word “blank” indicates that a blank optical holder should be used instead of a mirror or filter. A dash (—) indicates that no slot exists for a mirror in that PMT position.

The 6-Blue 6-Violet 0-UV 3-Red maps are:

- 6-Color Blue Octagon Default Configuration Map on page 149
- 6-Color Violet Octagon Default Configuration Map on page 151
- 3-Color Red Trigon Default Configuration Map on page 153

Table E-5 6-Blue 6-Violet 0-UV 3-Red default mirror and filter configuration

Detector Array (Laser)	PMT (Detector)	Longpass Dichroic Mirror	Bandpass Filter	Fluorochrome or Scatter Parameter
blue octagon (488-nm laser)	A	755 LP	780/60	PE-Cy7
	B	685 LP	695/40	PerCP-Cy5.5
	C	655 LP	660/20	PE-Cy5
	D	600 LP	610/20	PE-Texas Red™
	E	550 LP	575/26	PE
	F	505 LP	530/30	FITC, Alexa Fluor® 488
	G	blank	488/10	SSC
	H	—	blank	none
violet octagon (405-nm laser)	A	630 LP	655/8	Qdot 655
	B	595 LP	605/12	Qdot 605
	C	575 LP	585/15	Qdot 585
	D	545 LP	560/20	Qdot 565
	E	475 LP	525/50	AmCyan, Qdot 525
	F	blank	450/50	Pacific Blue™
	G	blank	blank	none
	H	—	blank	none
red trigon (633-nm laser)	A	755 LP	780/60	APC-Cy7
	B	710 LP	730/45	Alexa Fluor® 700
	C	—	660/20	APC

6-Blue 6-Violet 0-UV 4-Red Configuration

6-Blue 6-Violet 0-UV 4-Red supports blue, violet, and red octagons. Table E-6 shows the detectors, filters, and mirrors used in the default configuration. The word “blank” indicates that a blank optical holder should be used instead of a mirror or filter. A dash (—) indicates that no slot exists for a mirror in that PMT position.

The 6-Blue 6-Violet 0-UV 4-Red maps are:

- 6-Color Blue Octagon Default Configuration Map on page 149
- 6-Color Violet Octagon Default Configuration Map on page 151
- 4-Color Red Octagon Default Configuration Map on page 154

Table E-6 6-Blue 6-Violet 0-UV 4-Red default mirror and filter configuration

Detector Array (Laser)	PMT (Detector)	Longpass Dichroic Mirror	Bandpass Filter	Fluorochrome or Scatter Parameter
blue octagon (488-nm laser)	A	755 LP	780/60	PE-Cy7
	B	685 LP	695/40	PerCP-Cy5.5
	C	655 LP	660/20	PE-Cy5
	D	600 LP	610/20	PE-Texas Red™
	E	550 LP	575/26	PE
	F	505 LP	530/30	FITC, Alexa Fluor® 488
	G	blank	488/10	SSC
	H	—	blank	none

Table E-6 6-Blue 6-Violet 0-UV 4-Red default mirror and filter configuration (continued)

Detector Array (Laser)	PMT (Detector)	Longpass Dichroic Mirror	Bandpass Filter	Fluorochrome or Scatter Parameter
violet octagon (405-nm laser)	A	630 LP	655/8	Qdot 655
	B	595 LP	605/12	Qdot 605
	C	575 LP	585/15	Qdot 585
	D	545 LP	560/20	Qdot 565
	E	475 LP	525/50	AmCyan, Qdot 525
	F	blank	450/50	Pacific Blue™
	G	blank	blank	none
	H	—	blank	none
red octagon (633-nm laser)	A	755 LP	780/60	APC-Cy7
	B	710 LP	730/45	Alexa Fluor® 700
	C	675 LP	685/35	Alexa Fluor® 680
	D	—	660/20	APC
	E	blank	blank	none
	F	blank	blank	none
	G	blank	blank	none
	H	—	blank	none

6-Blue 6-Violet 2-UV 3-Red Configuration

6-Blue 6-Violet 2-UV 3-Red supports blue and violet octagons, and UV and red trigons. Table E-7 shows the detectors, filters, and mirrors used in the default configuration. The word “blank” indicates that a blank optical holder should be used instead of a mirror or filter. A dash (—) indicates that no slot exists for a mirror in that PMT position.

The 6-Blue 6-Violet 2-UV 3-Red maps are:

- 6-Color Blue Octagon Default Configuration Map on page 149
- 6-Color Violet Octagon Default Configuration Map on page 151
- 2-Color UV Trigon Default Configuration Map on page 152
- 3-Color Red Trigon Default Configuration Map on page 153

Table E-7 6-Blue 6-Violet 2-UV 3-Red default mirror and filter configuration

Detector Array (Laser)	PMT (Detector)	Longpass Dichroic Mirror	Bandpass Filter	Fluorochrome or Scatter Parameter
blue octagon (488-nm laser)	A	755 LP	780/60	PE-Cy7
	B	685 LP	695/40	PerCP-Cy5.5
	C	655 LP	660/20	PE-Cy5
	D	600 LP	610/20	PE-Texas Red™
	E	550 LP	575/26	PE
	F	505 LP	530/30	FITC, Alexa Fluor® 488
	G	blank	488/10	SSC
	H	—	blank	none

Table E-7 6-Blue 6-Violet 2-UV 3-Red default mirror and filter configuration (continued)

violet octagon (405-nm laser)	A	630 LP	655/8	Qdot 655
	B	595 LP	605/12	Qdot 605
	C	575 LP	585/15	Qdot 585
	D	545 LP	560/20	Qdot 565
	E	475 LP	525/50	AmCyan, Qdot 525
	F	blank	450/50	Pacific Blue™
	G	blank	blank	none
	H	—	blank	none
UV trigon (355-nm laser)	A	505 LP	530/30	Indo-1 (Blue)
	B	blank	450/50	Indo-1 (Violet), DAPI
	C	—	blank	none
red trigon (633-nm laser)	A	755 LP	780/60	APC-Cy7
	B	710 LP	730/45	Alexa Fluor® 700
	C	—	660/20	APC

6-Blue 6-Violet 2-UV 4-Red Configuration

6-Blue 6-Violet 2-UV 4-Red supports blue, violet, and red octagons, and a UV trigon. Table E-8 shows the detectors, filters, and mirrors used in the default configuration. The word “blank” indicates that a blank optical holder should be used instead of a mirror or filter. A dash (—) indicates that no slot exists for a mirror in that PMT position.

The 6-Blue 6-Violet 2-UV 4-Red maps are:

- 6-Color Blue Octagon Default Configuration Map on page 149
- 6-Color Violet Octagon Default Configuration Map on page 151
- 2-Color UV Trigon Default Configuration Map on page 152
- 4-Color Red Octagon Default Configuration Map on page 154

Table E-8 6-Blue 6-Violet 2-UV 4-Red default mirror and filter configuration

Detector Array (Laser)	PMT (Detector)	Longpass Dichroic Mirror	Bandpass Filter	Fluorochrome or Scatter Parameter
blue octagon (488-nm laser)	A	755 LP	780/60	PE-Cy7
	B	685 LP	695/40	PerCP-Cy5.5
	C	655 LP	660/20	PE-Cy5
	D	600 LP	610/20	PE-Texas Red™
	E	550 LP	575/26	PE
	F	505 LP	530/30	FITC, Alexa Fluor® 488
	G	blank	488/10	SSC
	H	—	blank	none

Table E-8 6-Blue 6-Violet 2-UV 4-Red default mirror and filter configuration (continued)

Detector Array (Laser)	PMT (Detector)	Longpass Dichroic Mirror	Bandpass Filter	Fluorochrome or Scatter Parameter
violet octagon (405-nm laser)	A	630 LP	655/8	Qdot 655
	B	595 LP	605/12	Qdot 605
	C	575 LP	585/15	Qdot 585
	D	545 LP	560/20	Qdot 565
	E	475 LP	525/50	AmCyan, Qdot 525
	F	blank	450/50	Pacific Blue™
	G	blank	blank	none
	H	—	blank	none
UV trigon (355-nm laser)	A	505 LP	530/30	Indo-1 (Blue)
	B	blank	450/50	Indo-1 (Violet), DAPI
	C	—	blank	none
red octagon (633-nm laser)	A	755 LP	780/60	APC-Cy7
	B	710 LP	730/45	Alexa Fluor® 700
	C	675 LP	685/35	Alexa Fluor® 680
	D	—	660/20	APC
	E	blank	blank	none
	F	blank	blank	none
	G	blank	blank	none
	H	—	blank	none

Special Order Configuration Trigon and Octagon Maps

If a slot contains a filter or mirror, a number appears in the corresponding position on the configuration map. If a slot contains a blank optical holder, nothing is written in the corresponding position on the configuration map.

The default configuration maps are:

- 6-Color Blue Octagon Default Configuration Map on page 149
- 2-Color Violet Trigon Default Configuration Map on page 150
- 6-Color Violet Octagon Default Configuration Map on page 151
- 2-Color UV Trigon Default Configuration Map on page 152
- 3-Color Red Trigon Default Configuration Map on page 153
- 4-Color Red Octagon Default Configuration Map on page 154

6-Color Blue Octagon Default Configuration Map

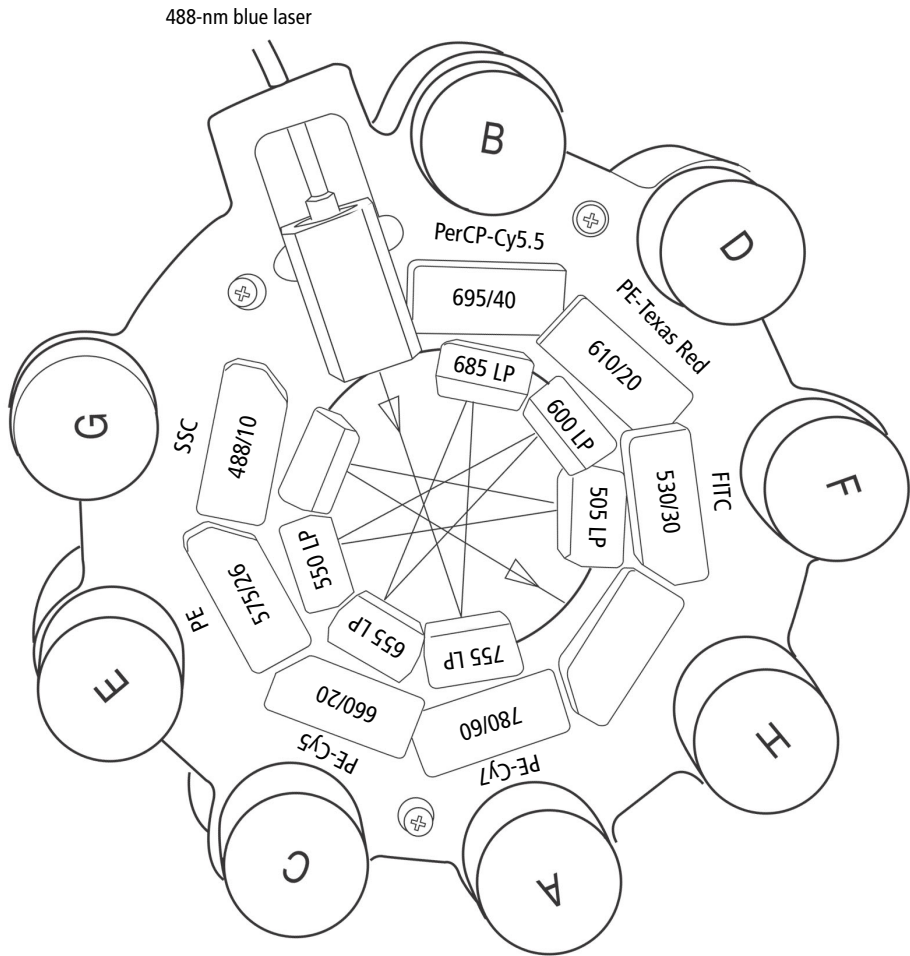

2-Color Violet Trigon Default Configuration Map

405-nm violet laser

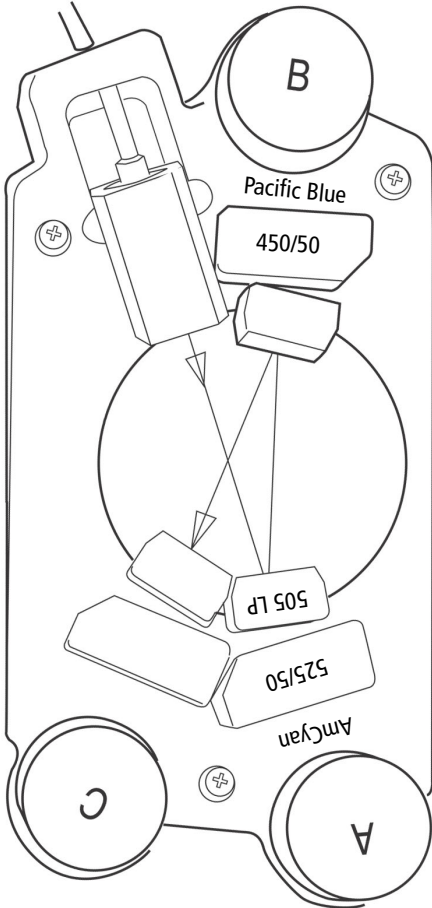

6-Color Violet Octagon Default Configuration Map

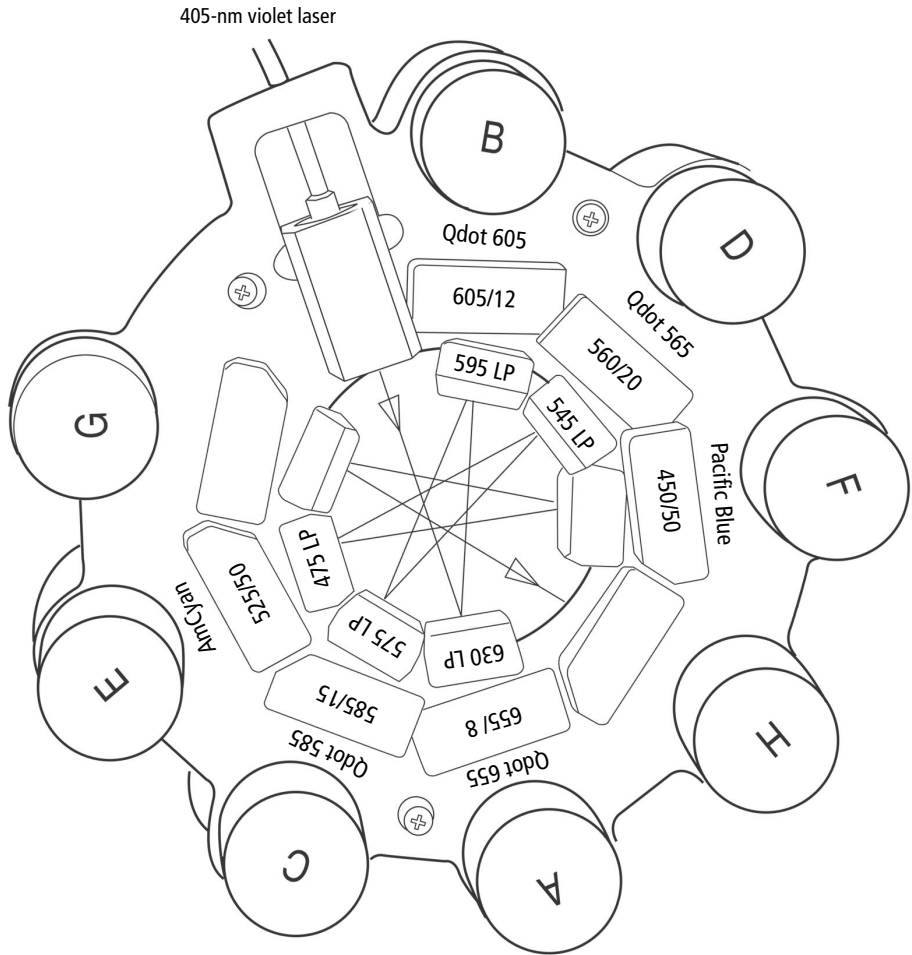

2-Color UV Trigon Default Configuration Map

355-nm UV laser

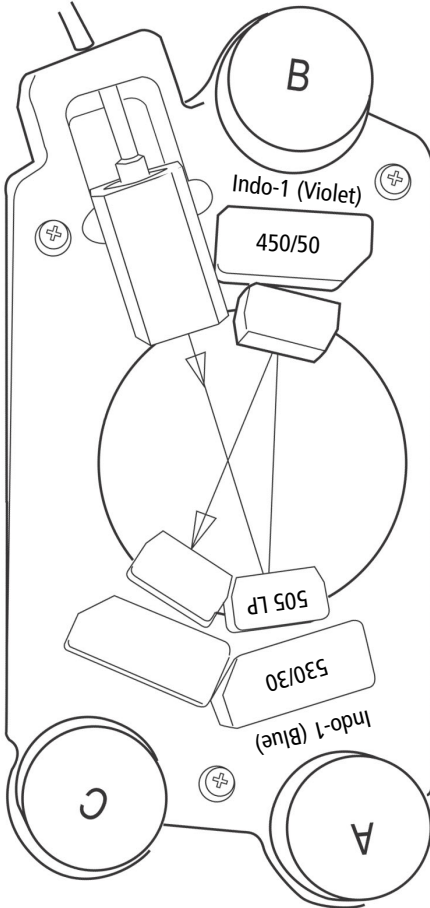

3-Color Red Trigon Default Configuration Map

633-nm red laser

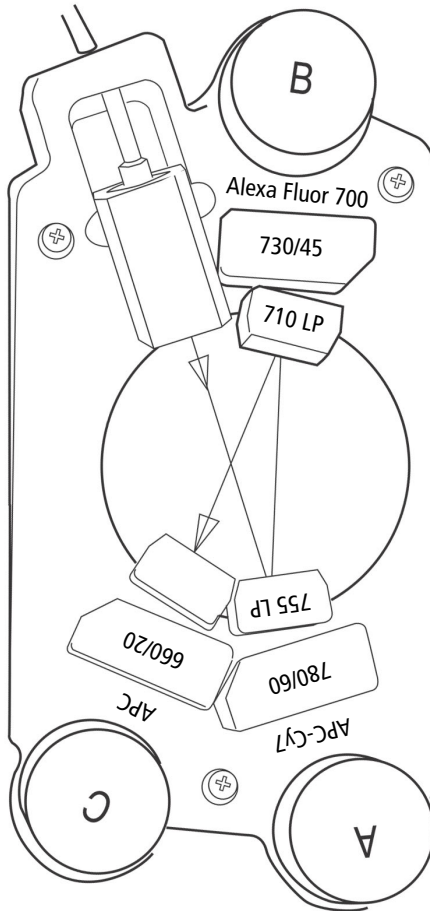

4-Color Red Octagon Default Configuration Map

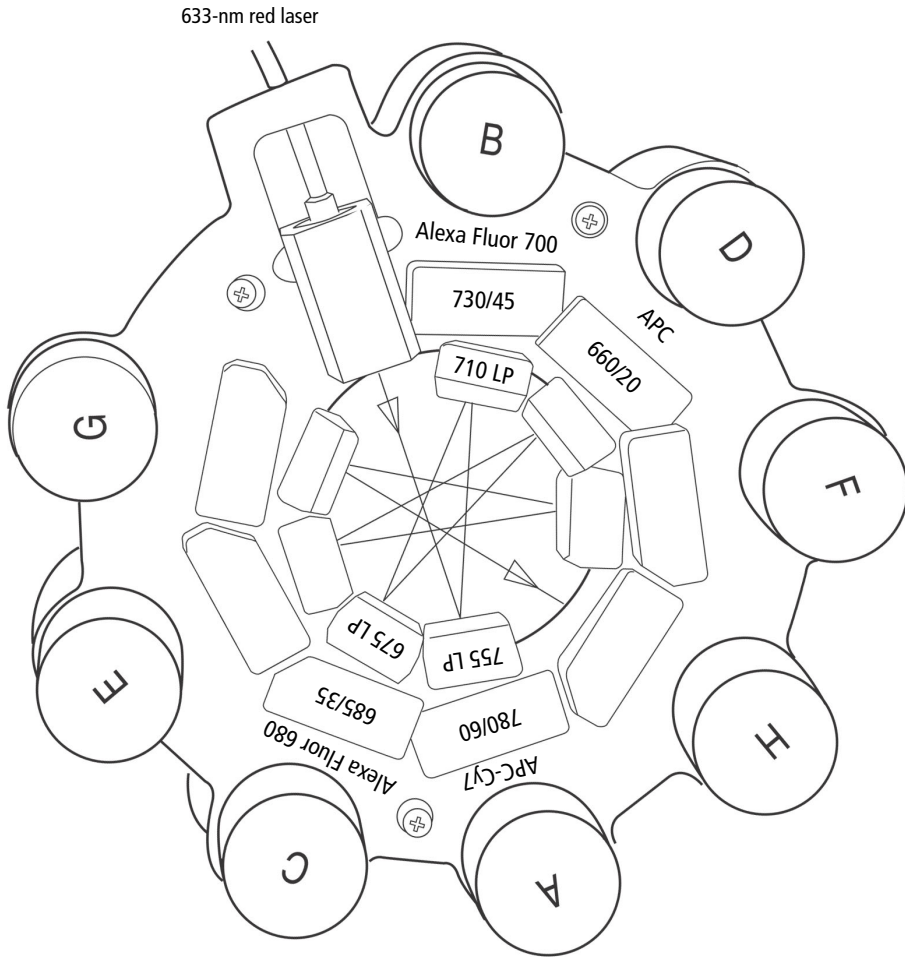

Appendix F

Setting Laser Delay

This appendix describes how to optimize laser delay settings in a multiple laser system.

- [About Laser Delay on page 156](#)
- [Optimizing Laser Delay on page 157](#)

About Laser Delay

Sample interrogation takes place within the cuvette flow cell. Laser light is directed through a series of prisms that focus multiple lasers on the event stream at different positions. This allows optimal detection of fluorescent signal from each laser with minimal cross-contamination from the other beams.

In the BD LSR II four-laser system, the blue laser intercepts the stream first, followed by the violet, UV, and red lasers. Because the laser signals are spatially separated, there is a slight delay between the detection of each laser's signal (Figure F-1).

Figure F-1 Signal separation over time

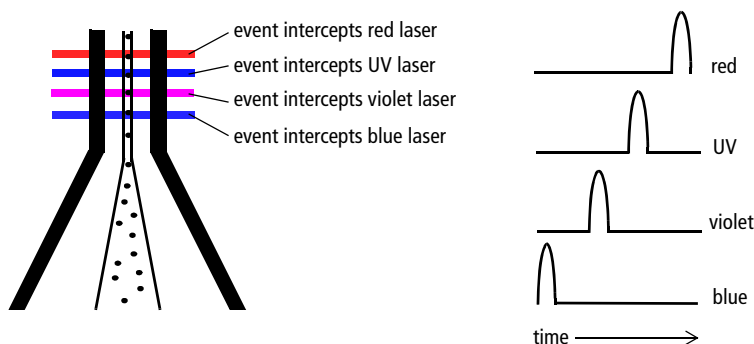

The laser delay setting in BD FACSDiva software is used to realign the signals so they can be measured and displayed on the same time scale. Signals are aligned with respect to the blue laser, so the blue laser will have a 0 delay value, and the red laser will have the longest delay.

Optimizing Laser Delay

Laser delay is set using BD FACSDiva software. To optimize the delay for a given laser, you acquire events from a sample with a fluorescence signal excited by that laser. Follow the procedures in Running Samples on page 53, for sample optimization and acquiring data.

To optimize laser delay:

- 1 While acquiring data from your sample, create a histogram to show the fluorescence signal excited by the laser in which the delay is to be optimized.
- 2 In the Acquisition Dashboard, set the Events to Display to 500 evt.
- 3 Select the Laser tab in the Cytometer window.

Window extension and laser delay values are displayed in microseconds (μsec).

Figure F-2 Laser tab of the Cytometer window

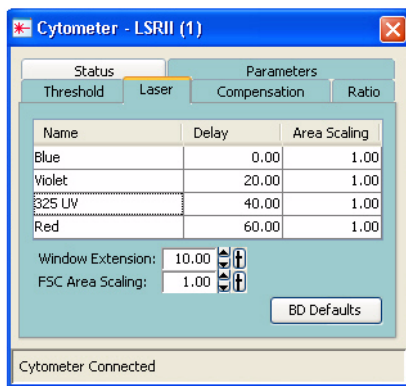

- 4 Set the window extension value to 0 μsec .
- 5 Set an initial laser delay value ONLY for the laser you are optimizing.

- If you are optimizing the violet laser, set its delay to 20 μsec .
 - If you are optimizing the UV laser, set its delay to 40 μsec .
 - If you are optimizing the red laser, set its delay to 60 μsec .
- 6** While observing the positive events on the histogram, adjust the laser delay in 1 μsec increments within a range of 10 μsec of the initial setting.

Choose the setting that moves the events farthest to the right (highest fluorescence intensity).

- 7** Draw an interval gate on the histogram for the positive events.
- 8** Create a statistics view to display the mean fluorescence intensity of the gated population.
- 9** While observing the mean fluorescence intensity for the gated population, adjust the laser delay in 0.1 μsec increments within a range of 2.0 μsec of the setting obtained in step 6.

You should also stay within a range of 10 μsec of the initial setting (see step 5).

Preserve the setting that maximizes the fluorescence intensity.

- 10** Reset the window extension to 10 μsec .

Index

A

acridine orange (AO) 81
adjusting
 threshold 63
 voltages 63
air in filter, removing 50
alarm, waste container 31
ALPHA filters (AFs) 35
analysis
 data 68
 immunophenotyping 72
 reusing 77
 saving 77
antibodies 106
arm, tube support 30
assistance, technical xv

B

Bal seal, replacing 90
bandpass (BP) filters 35, 109
 holder 42
 specifications 45
battery test 85
Battery Test switch, *shown* 85
battery, changing 86
BD FACSClean solution 81
BD FACSDiva software *See software*
BD FACSTFlow solution 47
BD FACSRinse solution 81
BD Falcon tubes 122

BD LSR II

 components 26
 cytometer optics 55
 online Help xii
 workstation 38
beam splitters *See* dichroic mirrors.
biohazards xx, 31
blank optical holders 42
bleach solution 81
blue laser 34
bubbles, removing air 50
buttons
 fluid control 28
 sample flow rate control 28

C

calculating compensation 66, 67
capacity, waste container 31
changing battery 86
Class I laser product xviii
Coherent lasers 34
compensation
 calculating 66, 67
 theory 111
 tubes, creating 61
components
 cytometer shown 26
 optical bench 32
computer system, about 38
configuration maps 126

- containers, sheath and waste 31, 46, 49
- control panel, cytometer 27
- controls
 - compensation 61
 - single-stained 55, 68
- cord, damaged xix
- covers, cytometer 26
- creating
 - analysis objects 72
 - compensation tubes 61
 - global worksheets 69
 - statistics view 73
- custom configurations 130
- cuvette flow cell 158
- CV, troubleshooting 100
- Cy-Chrome, filter configuration for 134
- cytometer 26
 - components *shown* 26
 - configuration 43, 55
 - covers and door 26, 44
 - dimensions xiii
 - handles 27, 32
 - setup 54
 - spares kit 130
 - symbols and labels xxi

D

- DAPI
 - cleaning after using 81
- data
 - analyzing 68, 72
 - gating 72
 - recording 68, 70
- debris
 - excessive 100
 - removing 63
- delay, laser 158

- detectors
 - photodiode 37
 - photomultiplier tubes (PMTs) 37
 - sensitivity 37
- dichroic
 - filters 35
 - mirrors 35, 111
- digital data 26
- discriminating filters (DFs) 110
- DNA
 - flow rate for analysis 104
- droplet containment system 30
- troubleshooting 94
- DsRed, filter configuration for 133

E

- electrical
 - requirements xiii
 - safety xix
- electronics 114
- emission duration 114
- environmental requirements xiii
- event rate
 - erratic 98, 99
 - high 97
 - low 98
 - zero 95, 96, 97
- excessive debris 100
- excitation wavelength 106
- experiments
 - immunophenotyping 69
 - sample optimization 58
- extra filters and mirrors 130

F

- Falcon tubes 94

- filters
 - bandpass 35
 - optical
 - bandpass 35, 109
 - changing 44
 - dichroic 35
 - discriminating 110
 - extra 130
 - longpass 35, 108
 - shortpass 35, 109
 - specifications 45
 - theory 107
 - sheath
 - replacing 88
- FITC and Stokes shift 106
- fixed-alignment lasers 26
- flow cell 104
 - draining 51
- flow rate control buttons 28
- fluid control buttons 28
- fluidics 104
 - cleaning 80
 - description 28, 104
 - flow rate control 28
 - flushing system 83
 - priming 51
 - removing air bubbles 50
 - run mode 28
 - sample injection port (SIP) 29, 30
- fluidics interconnect 50
- fluorescence 106
 - emission 114
- fluorochromes 111
 - emission spectra 107
 - filter configurations and 124, 130
 - role in light emission 106
 - which measured 43
- forward scatter (FSC) 33, 34, 105
- FSC and SSC voltages, adjusting 63
- FSC threshold, adjusting 63

G

- gating data 72
- global worksheets 72
 - creating 69
 - previewing data 68, 77

H

- handles, cytometer 27, 32
- hazards
 - biological xx, 31
 - electrical xix
 - laser xvii
- Hoechst 81
- hydrodynamic focusing 104

I

- immunophenotyping 104
 - analysis 72
 - data 69
 - experiment 69
- indo-1, filter configuration for 132

J

- JDS Uniphase HeNe 34

K

- knob
 - SAMPLE FINE ADJ 28
 - sheath clamp, *shown* 46

L

- labels on cytometer xxi
- laser delay 157

lasers
 about 34
 classification xviii
 power 34
 quality control (QC) 52, 120
 safety xvii
 warming up 40
 warmup times 34
longpass (LP) filters 35, 108
longpass dichroic mirrors
 holder 42
 specifications 45
LSR II *See* cytometer, BD LSR II.

M

maintenance
 fluidics
 daily cleaning 80
 flushing system 83
 periodic
 Bal seal 90
 replacing sheath filter 88
 sample tube O-ring 92
 scheduled
 battery change 86
 battery test 85
 system flush 83
 waste management system 85
Microsoft Windows operating
 system 38
mirrors
 dichroic longpass 35
 extra 130
 specifications 45

N

NCCLS documents xx

O

octagon
 description 32
 detector 26
 location 44
 shown 36
optical bench components 32
optics 55
 components 32
 cover 33
 custom filter configurations
 DsRed 133
 indo-1 132
 PerCP or BD Cy-Chrome 134
 PE-Texas Red 131
 dichroic mirrors 35, 111
 filters 35, 44, 107
 location 26
 steering 32, 36
optimization
 sample 54
ordering spare parts 119
O-ring, sample tube, replacing 92

P

PerCP
 filter configuration for 134
 Stokes shift 106
PE-Texas Red 131
photodiode 37
photomultiplier tubes (PMTs) 32, 37
population hierarchy 72
power
 requirements xix
 switch 26
priming fluidics system 51
propidium iodide (PI)
 cleaning after using 81

pulse
 definition 114
 measurements 116
 processors 116

Q

quality control (QC)
 about 52
 particles 120
 troubleshooting 101

R

Radius laser 34
recording
 compensation Tubes 65, 66
 data 68, 70
red laser 34
removing air bubbles, filter 50
replacing
 Bal seal 90
 battery 86
 optical filters 44
 sample tube O-ring 92
 sheath filter 88
requirements specifications xiii
reusing analyses 77

S

safety
 biological xx
 electrical xix
 general xxi
 laser xvii
 symbols and labels xxi

sample
 injection tube 30
 optimization 54
 experiment 58
 single-stained controls 55, 68
 tube requirements 94
SAMPLE FINE ADJ knob 28
sample injection port (SIP) 104
 cleaning 80
 components 29, 30
 problems with 94
 replacing Bal seal 90
 replacing sample tube O-ring 92
samples, running 70
Sapphire laser 34
saving analyses 77
scatter
 light 105
 parameter distortion 99
setting laser delay 157
setup, cytometer 54
sheath
 container 31, 46
 filter
 replacing 88
 flow 104
 fluid 104
 backflush 30
 pressure 104
sheath clamp knob 46
sheath container
 cap 47
 closing 47
 depressurize 47
shortpass (SP) filters 35, 109
Show Population Hierarchy 73
shutdown, cytometer 80
side scatter (SSC) 34, 105
signals, amplifying 37
SIP *See* sample injection port.

software
 adjusting detector voltages 37
 cytometer control xi
spares
 filters and mirrors 130
 kit 130
 parts, ordering 119
specifications, filter and mirror 45
spillover 112
statistics views 72
steering optics 32, 36
Stokes shift 106
switch, Battery Test 85
symbols on cytometer xxi

T

technical assistance xv
Technical Assistance, assistance
 technical xv
temperature requirements xiii
testing battery 85
text conventions xi
thiazole orange (TO) 81
threshold
 adjusting 63
 defined 117
trigon 37
 description 32
 detector 26
 location 44
tubes
 compensation 61
 requirements 94

U

ungrounded receptacles xix
user preferences 56
UV laser 34

V

violet laser 34
virus protection software xxiii
voltages, PMT, adjusting 63

W

waste container 31, 46
 alarm 31
 capacity 31
 emptying 48
window extension 159
workstation, about 38