M-Outpatient Health Care Usability Profile

v4OR
(M-OHCUP)

Date: ___/___/20__

Contact: _____

Clinic: _____

Contact Phone:(___) ___ - _____

Location: _____

Contact Email: _____

Reviewer: _____

Start Time: _____

End Time: _____

Total Time (Start-End)

Notes: _____

Contents

Section 1: Patient Arrival	3
Parking	3
Approach to Building.....	5
Ramps	7
Signage	9
Controls	13
Doors	14
Section 2: Public Facilities.....	16
Telephones.....	16
Seating	18
Counters	19
Passageways	20
Water Fountains	22
Lifts	24
Elevators.....	25
Stairs	29
Rest Rooms.....	31
Emergency Egress	40
Section 3: Access to Mammography Exam Room and Services.....	42
Appendix A: Parking Requirements.....	49
Appendix B: Overall Scoring Sheet	50
How to calculate your overall score.....	54
Appendix C: Mobility Scoring Sheet	55
How to calculate your mobility score	59
Appendix D: Sensory Scoring Sheet	60
How to calculate your sensory score.....	62
Appendix E: Cognitive Scoring Sheet.....	63
How to calculate your cognitive score	65

Section 1: Patient Arrival

Parking - applies only to parking area within the immediate vicinity of the clinic

1. The required number of designated parking spaces are provided (i.e. 10% of total parking spaces) and each designated space displays the symbol shown to the right (see Appendix A).
- Yes
- No



2. At least one in every eight designated parking spaces is van accessible.
- Yes
- No

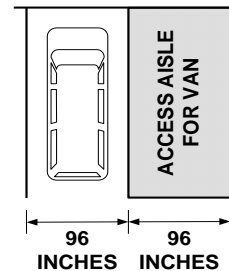

3. There are 98 inches of vertical clearance available for lift-equipped vans.
- Yes
- No
- N/A

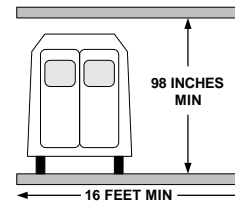

Mark "N/A" only if vehicles are parked in an open area (with any overhanging foliage above 98") and not in a parking garage.

-
4. All designated parking spaces are on the shortest route of travel to the building's accessible entrance. Yes No
- You may have to ask what the clinic considers their "accessible" entrance.
-

5. Access aisles are present between designated spaces and surfaces are firm, stable and slip resistant. Yes No
-

6. In designated passenger loading zones, there is an access aisle at least 5 feet wide and 25 feet long adjacent and parallel to a vehicle pull-up space. Yes No N/A

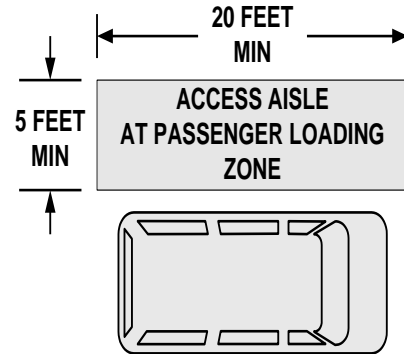

May be marked "Patient Drop-Off" or alternatively identified with signs or painted stripes. **If no identifiable zone, then mark "N/A."**

-
7. Curb ramps in the parking area have a smooth transition from the ramp to the pedestrian route of travel Yes No N/A

Mark "N/A" only if curb ramps are unnecessary.

NOTES : PARKING

Approach to Building- applies from parking area to entrance of building

8. The route of travel does not require the use of stairs. Yes No

9. The surface of the route of travel is stable, firm and slip-resistant. Yes No

10. The route leading to the building is at least 36 unobstructed inches wide. Yes No

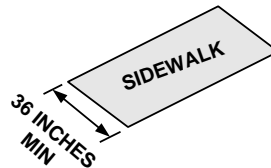

11. All curbs on the route of travel have curb ramps.	<input type="checkbox"/> Yes <input type="checkbox"/> No <input type="checkbox"/> N/A	<p>If no curbs, then write "N/A." Ramp should have/be: Slope < 1:12 (measured at steepest point), stable, firm, and slip resistant, 36 inches wide exclusive of flared sides. If ramp does not meet these criteria, mark "No."</p>
12. Where there are stairs at the main entrance, there is either a ramp, lift, or an alternative entrance provided.	<input type="checkbox"/> Yes <input type="checkbox"/> No <input type="checkbox"/> N/A	<p>Mark "N/A" if there are no stairs at main entrance.</p>
13. When alternative entrances are used, there is a sign at the main entrance indicating the location of the alternative entrance.	<input type="checkbox"/> Yes <input type="checkbox"/> No <input type="checkbox"/> N/A	<div data-bbox="954 779 1084 961" data-label="Image"> </div> <p>Mark "N/A" only if there are no alternative entrances used.</p>
14. Alternative entrances can be used without assistance.	<input type="checkbox"/> Yes <input type="checkbox"/> No <input type="checkbox"/> N/A	<p>Mark "N/A" only if there are no alternative entrances used.</p>
15. The entrance door has at least 32 inches clear opening (for a double door, at least one leaf with a 32- inch clear opening).	<input type="checkbox"/> Yes <input type="checkbox"/> No	<p>32 INCHES MIN CLEAR OPENING</p>
16. There is at least 18 inches of clear, unobstructed wall space.	<input type="checkbox"/> Yes <input type="checkbox"/> No <input type="checkbox"/> N/A	<p>18 INCHES MIN</p> <p>If the door is automatic, mark "N/A."</p>

17. All threshold edges are 1/4 inch high or less, or if beveled edge, no more than 1/2 inch high.
- Yes
- No

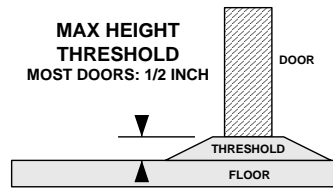

NOTES : APPROACH TO BUILDING

Ramps (where they exist along the path of travel)

Mark "N/A" if no ramps are present.

18. The slope of a ramp (rise over run) should be no greater than 1:12 (or 8.33%)
- Yes
- No
- N/A

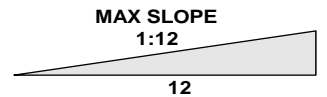

19. The surface of the ramp is stable, firm and slip resistant.
- Yes
- No
- N/A

20. The unobstructed width of the ramp is 36 inches.
- Yes
- No
- N/A

21. Any ramp that rises more than 6 inches or is longer than 72 inches has handrails on both sides.
- Yes
- No
- N/A

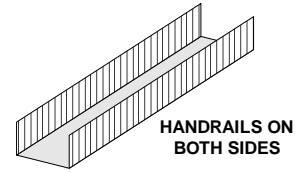

22. The tops of the handrails are between 34 and 38 inches above the ramp surface.
- Yes
- No
- N/A

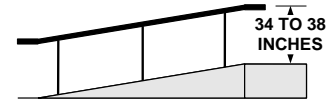

23. When the ramp changes direction, there is a level landing of at least 60 by 60 inches.
- Yes
- No
- N/A

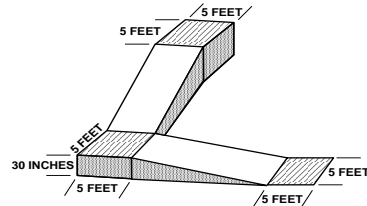

NOTES : RAMPS

Signage (those that direct to and within a clinic only)

Section A (Questions 24-26): Signs mounted above 80 inches.

Measure signs along path of travel from building entrance, to the clinic entrance, and within the clinic itself.

24. If mounted above 80 inches, characters on signs that provide directions and information have letters at least 3 inches high.	<input type="checkbox"/> Yes <input type="checkbox"/> No <input type="checkbox"/> N/A	Mark "N/A" if no signs are mounted above 80 inches.
--	---	---

25. If mounted above 80 inches, characters on signs that provide directions and information have high contrast.	<input type="checkbox"/> Yes <input type="checkbox"/> No <input type="checkbox"/> N/A	Mark "N/A" if no signs are mounted above 80 inches.
---	---	---

26. If mounted above 80 inches, characters on signs that provide directions and information have a non-glare finish.	<input type="checkbox"/> Yes <input type="checkbox"/> No <input type="checkbox"/> N/A	Mark "N/A" if no signs are mounted above 80 inches.
--	---	---

NOTES : SIGNS MOUNTED ABOVE 80 INCHES <hr/> <hr/> <hr/> <hr/> <hr/> <hr/> <hr/> <hr/> <hr/> <hr/>

Section B (Questions 27-35): Measure signs within clinic only.

27. Signs designating all permanent rooms and spaces are present
- Yes
- No

-
28. Signs are mounted with centerlines 60 inches from floor.

- Yes
- No
- N/A

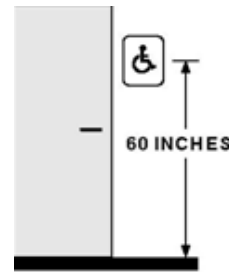

Measurement of 60 inches should be taken from on the middle of the sign.

Mark "NA" if answer to Q27 is "No."

-
29. Signs are mounted on the wall adjacent to the latch side of the door and outside the door swing.

- Yes
- No
- N/A

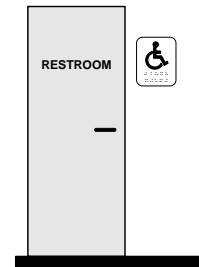

Mark "NA" if answer to Q27 is "No."

-
30. Signs have characters and background with a non-glare finish.

- Yes
- No
- N/A

Mark "NA" if answer to Q27 is "No."

31. Signs have raised characters.	<input type="checkbox"/> Yes <input type="checkbox"/> No <input type="checkbox"/> N/A	Mark "NA" if answer to Q27 is "No."
-----------------------------------	---	-------------------------------------

32. Signs feature high contrast lettering and backgrounds.	<input type="checkbox"/> Yes <input type="checkbox"/> No <input type="checkbox"/> N/A	Mark "NA" if answer to Q27 is "No."
--	---	-------------------------------------

33. Signs feature Braille text.	<input type="checkbox"/> Yes <input type="checkbox"/> No <input type="checkbox"/> N/A	Mark "NA" if answer to Q27 is "No."
---------------------------------	---	-------------------------------------

34. When a pictogram is used to designate rooms and spaces, it is accompanied by raised characters and Braille.	<input type="checkbox"/> Yes <input type="checkbox"/> No <input type="checkbox"/> N/A	Mark "N/A" if no pictograms are used.
---	---	---------------------------------------

35. If signs designating rooms and spaces do not have raised characters, Braille, or pictograms, or are not present, there is other directional assistance available (i.e., sound recordings, or a receptionist nearby).	<input type="checkbox"/> Yes <input type="checkbox"/> No	
--	---	--

NOTES : SIGNS WITHIN CLINIC

Section C (Question 35): Measure sign at clinic entrance only.

36. Sign is present at entrance to clinic at a height of 60 inches to centerline and features high contrast, raised and Braille characters, and non-glare finish.
- Yes
- No
-

NOTES : SIGN AT CLINIC ENTRANCE

Controls (e.g. light switches, door handles)

37. All controls available to the public have controls with the highest operable part no greater than 48" and lowest operable part no lower than 15".

- Yes
- No

Controls include light switches, locks, vending machines, television controls, fire alarms, etc.

38. All controls that are available to the public are operable with a single, closed fist.

- Yes
- No

NOTES : CONTROLS

Doors (within the clinic building, excluding the entrance doors)

39. When a door is opened to 90 degrees, there is a clear opening width of at least 32 inches measured between the face of the door and the door stop on the latch side.

- Yes
- No
- N/A

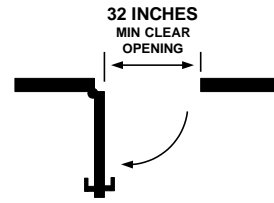

Mark "N/A" only if no doors are used within clinic.

40. Clear space between doors in a series is at least 48 inches.

- Yes
- No
- N/A

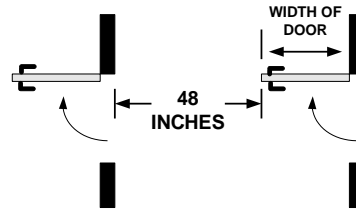

If both doors are automatic, then mark "N/A."

41. There is at least 18 inches of clear wall space on the latch side of doors.

- Yes
- No
- N/A

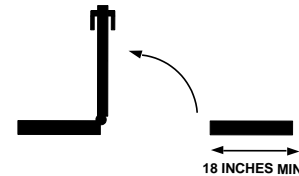

Judge doors from waiting room to exam room/ lab restroom on the path of travel only.

Mark "N/A" if door can be operated automatically.

42. The operating hardware is mounted no higher than 48 inches above the floor.

- Yes
- No
- N/A

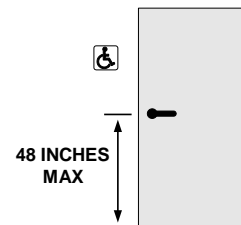

If door opens automatically with a sensor, enter "N/A."

43. All handles, locks, and latches or other opening hardware are operable with a single closed fist.
- Yes
 No
 N/A

Mark "N/A" only if no doors are used within clinic. If control operable, consider if usable with closed fist.

44. All threshold edges are 1/4 inch high or less, or if beveled edge, no more than 1/2 inch high.
- Yes
 No
 N/A

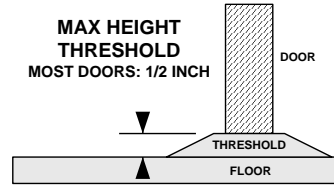

45. No more than five pounds of force is required to open an interior door (e.g., restroom door).
- Yes
 No
 N/A

Mark "N/A" if all doors used by public are automatic.

46. No more than 8.5 pounds of force is required to open an exterior door.
- Yes
 No
 N/A

Mark "N/A" if all doors used by public are automatic.

NOTES : DOORS

Section 2: Public Facilities

Telephones (any available for public use along path of travel)

Mark "N/A" if no telephone is available for public use.

47. The designated telephone has at least 30 by 48 inches of clear floor space.

- Yes
- No
- N/A

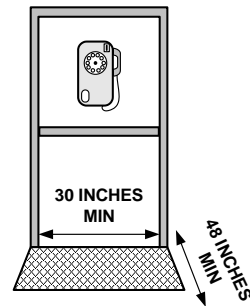

48. The route to the telephone is at least 36 unobstructed inches wide adjoining or overlapping the clear floor space.

- Yes
- No
- N/A

49. The highest operable part of the phone is no higher than 48 inches. Be sure to check coin and/or credit card slot height.

- Yes
- No
- N/A

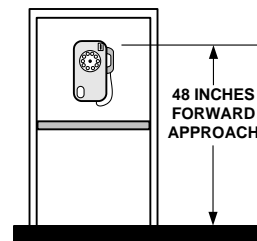

50. If a wall-mounted telephone has a leading edge between 27 and 80 inches from the floor, it projects less than 4 inches into the pathway.
- Yes
- No
- N/A

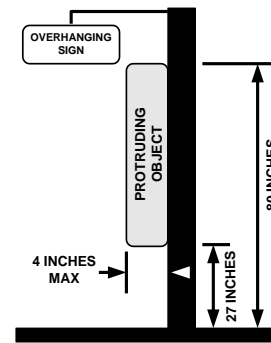

Enter "Yes" if telephone is recessed and not projecting into passageway.

51. The designated phone is adapted with volume control.
- Yes
- No
- N/A

Alternatively, look for volume adjustment button near keypad.

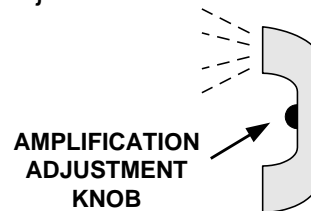

52. Volume controlled telephones are identified by a sign showing a handset radiating sound waves.
- Yes
- No
- N/A



53. When telephone banks (2 or more adjacent public phones) do not contain a text telephone (TTY), there is a sign to indicate location of nearest TTY.
- Yes
- No
- N/A



NOTES : TELEPHONE

Seating (in waiting area only)

54. All aisles between seating are at least 36 unobstructed inches wide.

Yes
 No
 N/A

Mark "N/A" only if no seating area is available.

55. There is a space for a person in a wheelchair to wait without blocking the clear width of any aisles.

Yes
 No
 N/A

Mark "N/A" only if no seating area is available.

NOTES : SEATING

Counters (along the path of travel)

56. The tops of tables or counters are between 28 and 34 inches high.
- Yes
 - No
 - N/A

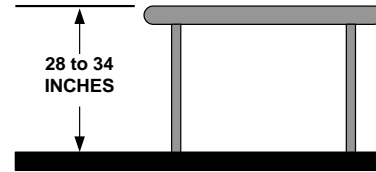

57. When tables* are provided (excluding end tables) at least one has knee space of at least 27 inches high, 30 inches wide and 19 inches deep.
- Yes
 - No
 - N/A

*This question is concerned with tables or counters that provide seats (or transaction areas) for both clinic personnel and patients - for example, a check-out station, registration area, or reception desk.

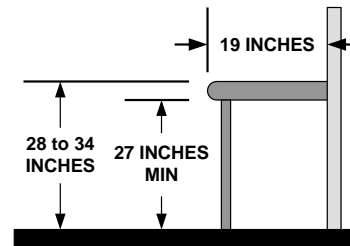

NOTES : COUNTERS

Passageways (i.e., route of travel to clinic services excluding doorways)

58. All passageways are at least 36 unobstructed inches wide.

- Yes
- No
- N/A

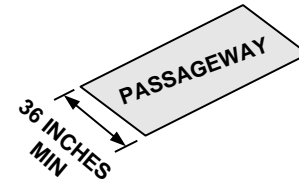

If temporary objects protrude into passageway, then measure passageway to edge of object.

59. If the passageway is **less than 60 inches wide**, there are passing spaces at least 60 inches wide and 60 inches long or intersecting walks allowing passing at reasonable intervals not exceeding 200 feet.

- Yes
- No
- N/A

If passageway is more than 60 inches wide, mark N/A.

60. There is a 5-foot circle or T-shaped space (36 inches wide each direction and 60 inches minimum depth) to reverse direction.

- Yes
- No
- N/A

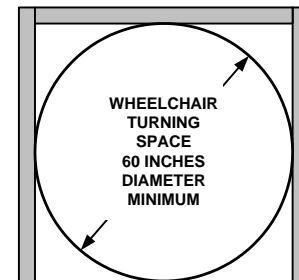

Note: This is a difficult measurement to make. It may require 2 people working together to make an accurate reading. Study the diagram closely, and take your time making your measurement.

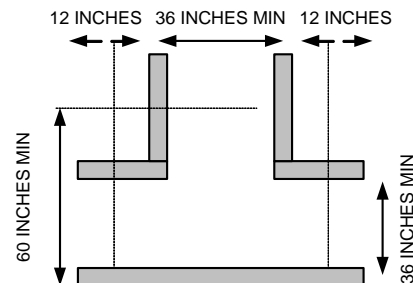

61. Where a passageway makes a U-turn around an obstacle which is less than 48 inches wide, the passageway width increases to at least 42 inches on the approaches and 48 inches in the turn.

- Yes
- No
- N/A

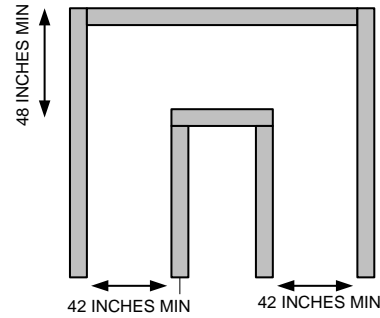

Mark "N/A" if there is no U-turn around obstacle.

62. If passageway levels change, the vertical difference is less than 1/4 inch, or if the change in level is between 1/4 and 1/2 inch, there is a beveled edge with a slope no greater than 1:2.

- Yes
- No
- N/A

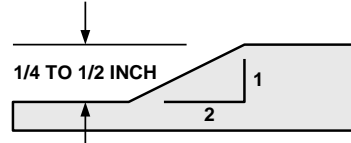

Mark "N/A" if there is no change in floor level.

63. Objects mounted on the wall that have leading edges between 27 inches and 80 inches from the floor project less than 4 inches into the passageway.

- Yes
- No
- N/A

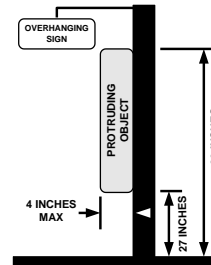

Mark "N/A" if no protruding objects found. Objects with edges that extend below 27" are not considered obstructions because they are cane-detectable.

64. Carpeting is low-pile, tightly woven and securely attached along edges.

- Yes
- No
- N/A

NOTES : PASSAGEWAYS

Water Fountains (where they exist along the path of travel)

Mark "N/A" if no fountain is available to the public.

65. Where fountains are provided, there is a clear floor space of at least 30 by 48 inches.

- Yes
- No
- N/A

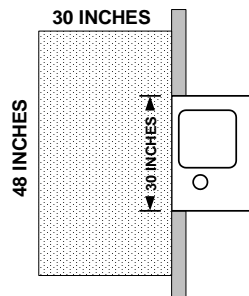

66. When fountains are provided, there is at least one fountain with its spout fixture no higher than 36 inches from the floor.

- Yes
- No
- N/A

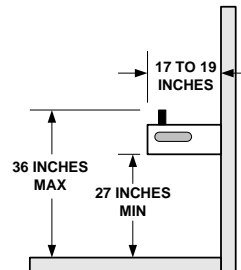

67. If a wall-mounted fountain has a leading edge between 27 and 80 inches from the floor, it projects less than 4 inches into the pathway.

- Yes
- No
- N/A

[Note: Many times, there is a high-low fountain arrangement. The high fountain may be a protruding object if it is not recessed or does not have an extension underneath to bring it down to 27" to be cane detectable.]

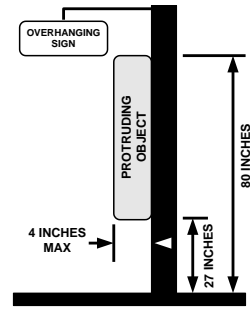

Enter "Yes" if fountain is recessed and not projecting into passageway.

NOTES : WATER FOUNTAINS

Lifts (when provided along the path of travel)

Mark "N/A" only if lift is not required to access clinic services and public facilities.

68. Where a lift is provided, it is usable without assistance (e.g., key is in lock and doesn't have to be located; door is operable with a closed fist).

Yes

No

N/A

Yes

69. If the lift is not usable without assistance, a call button is provided.

No

N/A

Yes

70. The lift controls are operable with a closed fist.

No

N/A

Yes

71. The lift controls are located no higher than 48 inches for a forward approach.

No

N/A

Yes

72. The lift controls are located no higher than 54 inches for a side approach.

No

N/A

-
73. The floor surface of the lift is slip-resistant and any change in level is less than 1/4 inch.
- Yes
- No
- N/A
-

NOTES : LIFTS

Elevators (where they exist along the path of travel)

Mark "N/A" if elevators are not required to access clinic services and public facilities.

-
74. The call button has a visual signal that indicates direction of travel.
- Yes
- No
- N/A
-

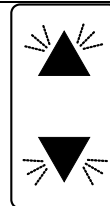

75. The call button has an audible signal that indicates direction of travel.

- Yes
- No
- N/A

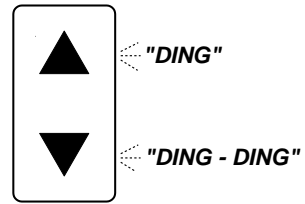

76. There are signs identifying the floor number in raised letters on both sides of the door jamb of the elevator at every floor.

- Yes
- No
- N/A

77. There are signs identifying the floor in Braille letters on both door jambs of the elevator at every floor.

- Yes
- No
- N/A

78. The elevator automatically comes within 1/2 inch of the floor landing at each stop.

- Yes
- No
- N/A

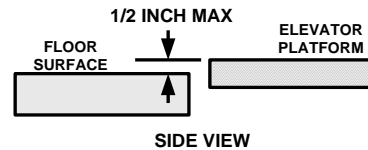

79. The elevator is large enough that a wheelchair user can enter, reach the controls and exit.

- Yes
- No
- N/A

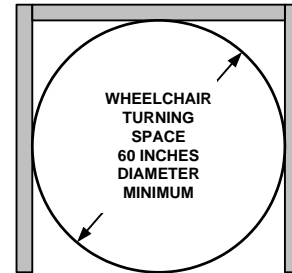

80. The elevator doors reopen automatically without contact if an object passes through the opening between 5 and 29 inches above the floor.

- Yes
- No
- N/A

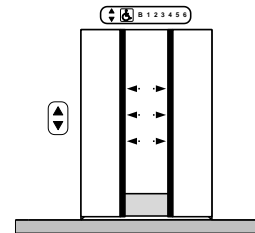

81. When reopened, it stays open for **at least 20 seconds.**

- Yes
- No
- N/A

82. The control buttons inside the elevator have Braille lettering.

- Yes
 - No
 - N/A
-

83. The control buttons inside the elevator have raised lettering.

- Yes
- No
- N/A

84. If provided, the emergency communication system (e.g., handset, intercom) is identified in both Braille and raised letters.

- Yes
- No
- N/A

85. If provided, the emergency communication system (e.g., handset, intercom) is no higher than 48 inches above the floor.

- Yes
- No
- N/A

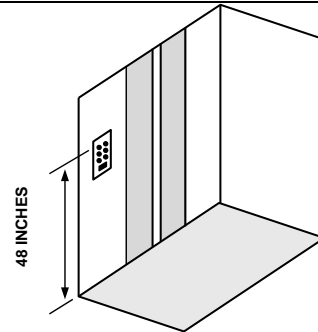

86. All elevator controls are no lower than 15 inches and no higher than 48 inches from floor.

- Yes
- No
- N/A

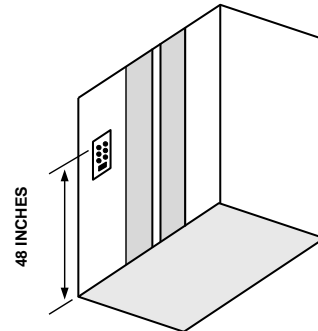

NOTES : ELEVATORS

Stairs (where they exist along the path of travel)

Mark "N/A" only if stairs are not a part of the path to clinic services and public facilities.

87. Handrails have 12-inch extensions beyond the top riser.

- Yes
- No
- N/A

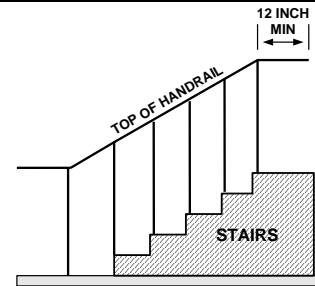

88. Handrails have 12-inch extensions beyond the bottom riser.

- Yes
- No
- N/A

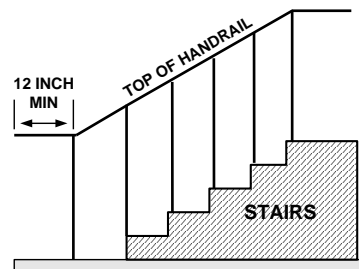

89. For stairs along the path of travel, the risers are closed.

- Yes
- No
- N/A

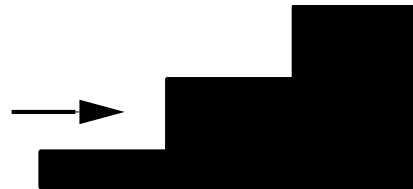

90. For stairs along the path of travel, the steps have uniform riser height and tread width.

- Yes
 - No
 - N/A
-

-
91. If there are stairs between the elevator and primary clinic services, there is a designated route without stairs.
- Yes
 - No
 - N/A
-

NOTES : ELEVATORS

Rest Rooms (Instructions: Assess restroom in public waiting room only).

Features for both toilet stalls and toilet rooms.

92. Signs are mounted on the wall on the latch side of the door, 60 inches from the floor to the middle of the sign.
- Yes
 No

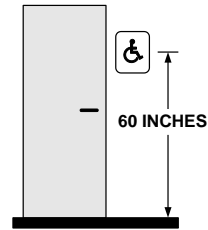

Measurement of 60 inches should be taken from the middle of the sign.

93. Where pictograms or symbols are used to identify rest rooms, Braille characters are included below them.
- Yes
 No
 N/A

Mark "N/A" if no pictograms are used.

94. Where pictograms or symbols are used to identify rest rooms, raised characters are included below them.
- Yes
 No
 N/A

Mark "N/A" if no pictograms are used.

95. The restroom doorway is at least 32 inches wide.
- Yes
 No

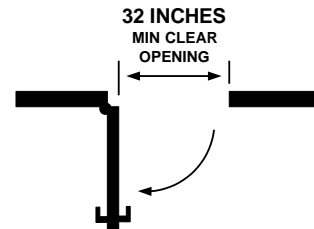

96. Doors are operable with a single, closed fist.
- Yes
 No

If control is operable, consider whether it is usable with a single, closed fist.

97. Door handles are placed no higher than 48 inches.

- Yes
- No
- N/A

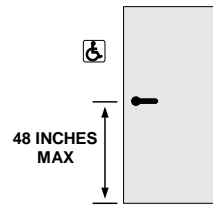

Mark "N/A" only if door is automatic and operable control is no higher than 48 inches.

98. The entry is large enough for a wheelchair user to enter, turn around and exit.

- Yes
- No

Note: This is a difficult measurement to make. It may require 2 people working together to make an accurate reading. Study the diagram closely, and take your time.

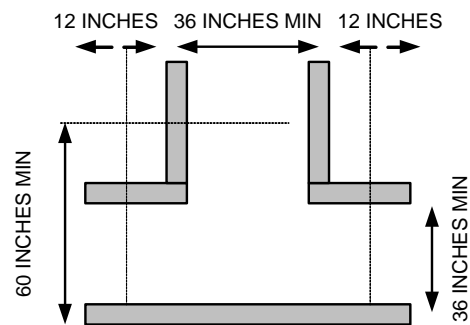
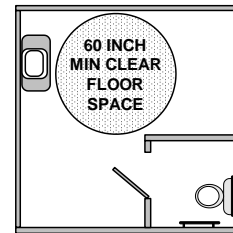

99. There is a 36-inch wide unobstructed path to all fixtures (e.g., sink, soap dispensers).

- Yes
- No

100. The sink has a 30-inch wide by 48-inch deep clear space in front (a maximum of 19 inches of the required depth may be under the sink).

- Yes
- No
- N/A

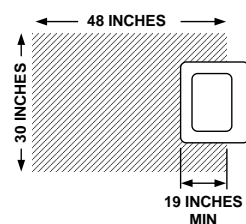

Mark "N/A" only if there is no sink.

101. Pipes under the sink are covered to protect against contact.

- Yes
- No
- N/A

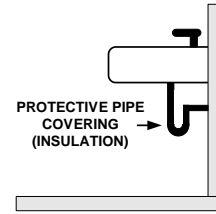

Mark "N/A" only if there is no sink.

102. Where counters or tables are provided, the top is between 28 and 34 inches from the floor.

- Yes
- No
- N/A

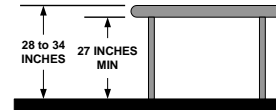

103. The sink rim is no higher than 34 inches.

- Yes
- No
- N/A

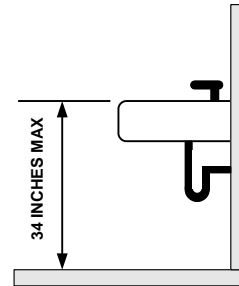

Mark "N/A" only if there is no sink.

104. The faucet is operable with a single closed fist.

- Yes
- No
- N/A

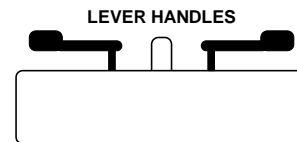

Mark "N/A" only if there is no sink.

105. The highest operable part of all dispensers and hand dryers is no higher than 48 inches for a forward approach.

- Yes
- No
- N/A

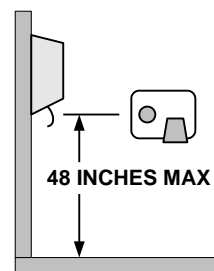

Mark "N/A" only if there are no dispensers.

-
106. All dispensers and hand dryers are operable with a single closed fist (pull-down paper-towel dispensers & many seat-cover dispensers are usually not accessible by this criteria).
- Yes
- No
- N/A

Mark "N/A" only if there are no dispensers.

-
107. The mirror is mounted with the bottom edge of the reflecting surface no higher than 40 inches.
- Yes
- No
- N/A

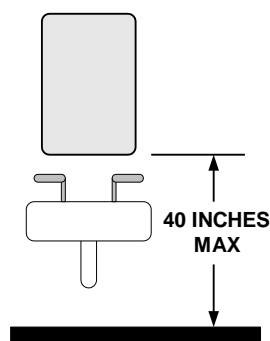

Note: This is a difficult measure to take and sometimes requires more than one measurement. Please use caution.

Mark "N/A" only if there is no mirror.

-
108. There are two horizontal grab bars: one on the wall behind the toilet and one on the side wall nearest to the toilet in the designated stall/toilet room.
- Yes
- No

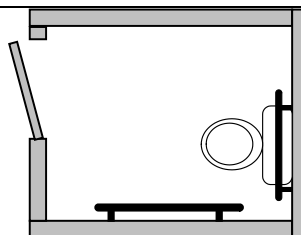

Mark "No" if grab bars are not present or are not positioned parallel to floor.

-
109. The toilet seat is 17"-19" high. Measure from floor to top of seat.
- Yes
 No

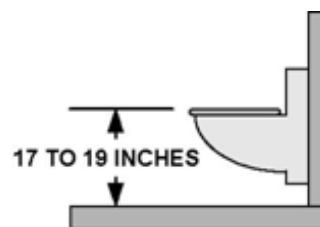

-
110. There is at least 18 inches of clear space from the center of the toilet to the wall(s) on either side.
- Yes
 No

Note: Make measurement to adjacent wall. Do not include objects such as toilet paper dispensers in your measurement.

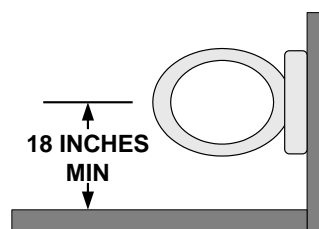

-
111. At all rest rooms, there is a sign indicating the location of the designated rest room(s).
- Yes
 No
 N/A

This question is specific for other restroom locations. Mark "Yes" if non-accessible restrooms provide directional signage to accessible restroom. Mark "N/A" only if: 1) other public restrooms do not exist/are not available to public; or 2) other public restrooms are accessible.

FOR TOILET STALLS ONLY

Mark "N/A" if there are no toilet stalls. Proceed to next section: Toilet Room.

112. All stall door hardware is operable with a single, closed fist.
- Yes
- No
-

113. When stall door is open 90 degrees, there is at least 32-inches' clear width.
- Yes
- No

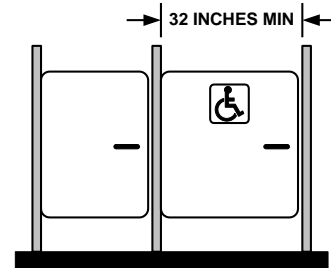

114. There is a designated stall with a clear floor space of at least 5 feet long by 5 feet wide.
- Yes
- No
- N/A

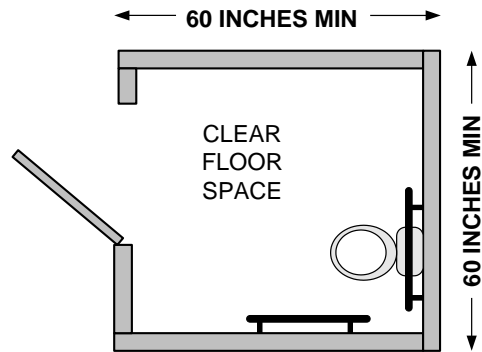

115. Where there is no stall with a clear floor space of five feet long and five feet wide, there is a stall that either 36 by 69 inches or 48 inches by 69 inches.

- Yes
- No
- N/A

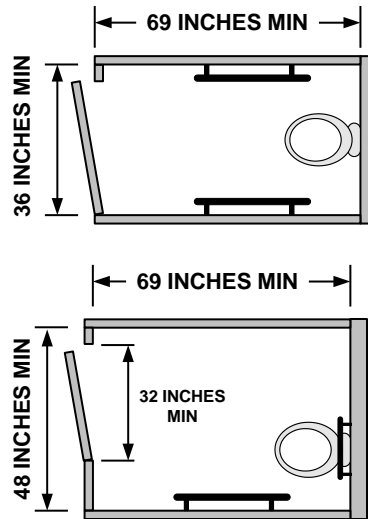

116. There is at least 18 inches of clear space at the latch side of the stall door.

- Yes
- No

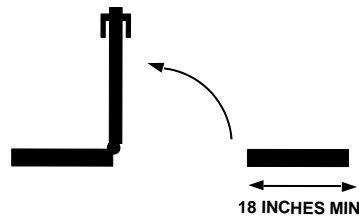

NOTES : TOILET STALLS ONLY

(Proceed to next section!!)

FOR TOILET ROOMS ONLY

Mark "N/A" if toilet rooms do not exist (i.e., there are stalls only) **or** if room floor plan is not applicable.

117. Where the toilet is approached from the front and there is a sink alongside the toilet, there is clear floor space of at least 48 inches wide by 66 inches long (toilet wall to opposite wall).
- Yes
 - No
 - N/A

If door swings inward, measure space clear of door swing. This is easiest done with 2 people.

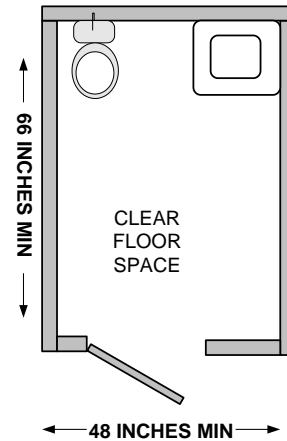

118. Where the toilet is approached from the side and there is a sink alongside the toilet, there is clear floor space of at least 48 inches wide by 56 inches long (toilet wall to opposite wall).
- Yes
 - No
 - N/A

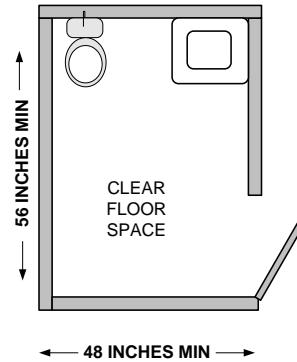

119. Where there is no sink alongside the toilet, there is a clear floor space of at least 60 inches wide by 56 inches long (toilet wall to opposite wall).
- Yes
 - No
 - N/A

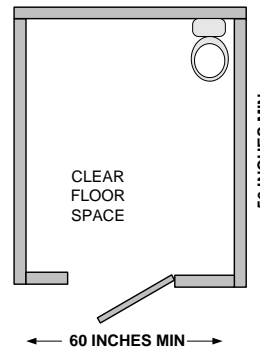

NOTES : TOILET ROOMS ONLY

Emergency Egress (a route or path for going out in case of an emergency)

120. The emergency route is at least 36 unobstructed inches wide.

- Yes
- No

If temporary objects protrude into passageway, then measure passageway to edge of object.

121. The emergency route does not require the use of stairs.

- Yes
- No

122. Exit doors along the emergency route are accessible doors.

- Yes
- No

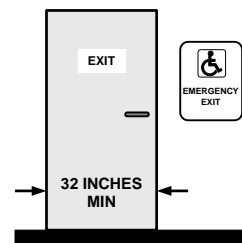

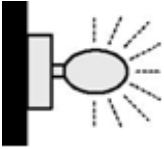
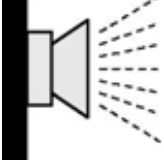
<p>123. Where emergency alarms are provided, they have flashing lights.</p>	<p><input type="checkbox"/> Yes <input type="checkbox"/> No</p>	
<p>124. Where emergency alarms are provided, they have audible signals.</p>	<p><input type="checkbox"/> Yes <input type="checkbox"/> No</p>	
<p>125. Where emergency alarms are provided, additional visual alarms are installed in general use areas such as hallways, lobbies and restrooms.</p>	<p><input type="checkbox"/> Yes <input type="checkbox"/> No</p>	
<p>126. The visual alarms are placed 80 inches above the highest floor level within the space or 6 inches below the ceiling, whichever is lower.</p>	<p><input type="checkbox"/> Yes <input type="checkbox"/> No</p>	
<p>127. Each area of rescue assistance provides at least 2 clear spaces no smaller than 30 by 48 inches.</p>	<p><input type="checkbox"/> Yes <input type="checkbox"/> No <input type="checkbox"/> N/A</p>	<p>NOTE: Areas of rescue assistance are not required in 1-story buildings without elevators. Mark "N/A" for ground-level facilities.</p>
<p>128. Each stairway serving an area of rescue assistance is at least 48 inches wide between handrails.</p>	<p><input type="checkbox"/> Yes <input type="checkbox"/> No <input type="checkbox"/> N/A</p>	

NOTES : EMERGENCY EGRESS

Section 3: Access to Mammography Exam Room and Services

129. There is a loaner wheelchair available. Yes No You may have to ask receptionist if a loaner wheelchair is not readily apparent.

130. There is a 36-inch passageway (excluding doorways) from the waiting area to designated exam room. Yes No

131. There are graphic charts for assessing pain for patients with cognitive disabilities. Yes No You may have to ask clinic personnel if a chart is available for use.

132.	There is at least one lift or transfer device in exam room.	<input type="checkbox"/> Yes <input type="checkbox"/> No <input type="checkbox"/> N/A	Mark “N/A” only if this feature is not needed. Consider whether a transfer device (e.g., step stool with arm support) is needed to get on exam table.
133.	All controls (e.g., light switches, door handles) are operable with a closed fist.	<input type="checkbox"/> Yes <input type="checkbox"/> No <input type="checkbox"/> N/A	Controls include light switches, locks, vending machines, television controls, fire alarms, etc. Mark “N/A” if patient does not need to access controls in exam room.

NOTES : EXAM ROOM

Accessible Exam Table

[Material in this section excerpted from the **2008 Massachusetts Facility Assessment Tool (MFAT)**, which compiles standards from the Americans with Disabilities Act of 1990 (ADA), the Massachusetts Architectural Access Board codes, and other Massachusetts Department of Public Health requirements.]

134. There is at least one height adjustable exam table (lowers to 17"-19", measured from the floor to the top of the table).

Yes
 No
 N/A

Yes

135. The table is able to support body weight of 300 pounds or more.

No
 N/A

Yes

136. Is there at least one accessible exam table in an accessible exam room?

No
 N/A

NOTES : EXAM TABLE

Accessible Dressing Room

[Material in this section excerpted from the **2008 Massachusetts Facility Assessment Tool (MFAT)**, which compiles standards from the Americans with Disabilities Act of 1990 (ADA), the Massachusetts Architectural Access Board codes, and other Massachusetts Department of Public Health requirements.]

137. The accessible dressing room is located on an accessible route.
- Yes
 No

138. Dressing room has a T-shaped clear floor space or one that is 60" in diameter for a wheelchair to make a 180° turn.
- Yes
 No

If dressing room door swings inward, measure space clear of door swing.

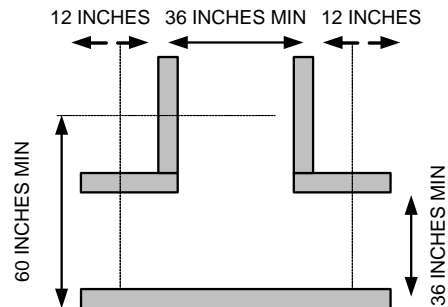
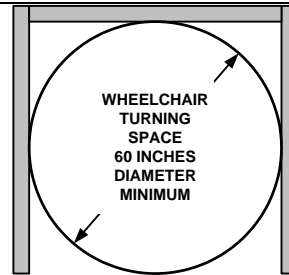

139. Dressing room has a mirror at least 18" wide, 54" high, mounted at least 18" above the floor in a position to afford a view when standing or sitting on the seat/bench.
- Yes
 No

140. Room has a coat hook located a maximum of 48" above the floor.
- Yes
 No
-

141. Room has a bench at
least 42" wide. Yes
 No

142. Bench is 17"-19" high. Yes
 No

143. Bench is at least 20-24"
deep. Yes
 No

NOTES : DRESSING ROOM

(Proceed to next section!!)

Accessible Mammography Machine

[Material in this section excerpted from the **2008 Massachusetts Facility Assessment Tool (MFAT)**, which compiles standards from the Americans with Disabilities Act of 1990 (ADA), the Massachusetts Architectural Access Board codes, and other Massachusetts Department of Public Health requirements.]

144. The mammography machine is on an accessible route. Yes
 No

145. The machine has a positioning chair with a braking device and adjustable arms available for ready access. Yes
 No

146. The machine has a breast platform that lowers to a height of 24"-27" above the floor to the top side of the platform. Yes
 No
- (NOTE EXCEPTION TO MFAT: This question varies the height requirement from the original MFAT standard of 24".)

147. The machine has a 60" diameter circle of clear floor space or a T-shaped clear floor space as shown adjacent to the machine. Yes
 No

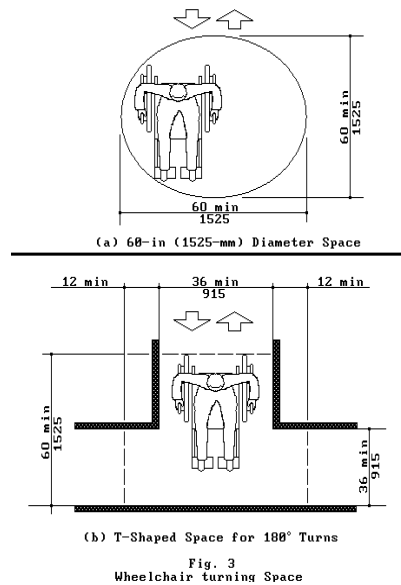

148. Does at least one mammography machine meet ALL of the above standards? Yes No

NOTES : MAMMOGRAPHY MACHINE

Appendix A: Parking Requirements

Total Parking Spaces:	Required Minimum Number of Spaces:
1 to 25	1
26 to 50	2
51 to 75	3
76 to 100	4
101 to 150	5
151 to 200	6
201 to 300	7
301 to 400	8
401 to 500	9
501 to 1000	2% of total
1001 and over	20 plus 1 for each 100 over 1000

*Number of required parking spaces for outpatient units and facilities: **10 percent of the total number** of parking spaces provided serving each such outpatient unit or facility. **Note: When calculating the number of accessible spaces needed, round the number up to the next whole number if the number comes out unevenly. For example, if a lot has 83 spaces, 10 percent would be 8.3 spaces. It is required that the partial number be rounded up, so the number of spaces needed is 9.***

Appendix B: Overall Scoring Sheet

Your Overall Score

To calculate an overall score, please enter “1” for each item that received a YES or N/A mark next to the corresponding question number below.

<i>Section 1: Patient Arrival</i>	
Parking	
1	
2	
3	
4	
5	
6	
7	
Approach to Building	
8	
9	
10	
11	
12	
13	
14	
15	
16	
17	
Ramps	
18	
19	
20	
21	
22	
23	

Signage	
24	
25	
26	
27	
28	
29	
30	
31	
32	
33	
34	
35	
36	
Controls	
37	
38	
Doors	
39	
40	
41	
42	
43	
44	
45	
46	

Section 2: Public Facilities	
Telephones	
47	
48	
49	
50	
51	
52	
53	
Seating	
54	
55	
Counters	
56	
57	
Passageways	
58	
59	
60	
61	
62	
63	
64	
Water Fountains	
65	
66	
67	
Lifts	
68	
69	
70	
71	

Lifts (continued)	
72	
73	
Elevators	
74	
75	
76	
77	
78	
79	
80	
81	
82	
83	
84	
85	
86	
Stairs	
87	
88	
89	
90	
91	
Restrooms	
92	
93	
94	
95	
96	
97	
98	
99	
100	
101	
102	

Restrooms (continued)	
103	
104	
105	
106	
107	
108	
109	
110	
111	
112	
113	
114	
115	
116	
117	
118	
119	
Emergency Egress	
120	
121	
122	
123	
124	
125	
126	
127	
128	

Section 3: Mammography Exam Room and Access to Services	
129	
130	
131	
132	
133	
Accessible Exam Table	
134	
135	
136	
Accessible Dressing Room	
137	
138	
139	
140	
141	
142	
143	
Accessible Mammography Machine	
144	
145	
146	
147	
148	

How to calculate your overall score

Example:

Count how many items you marked YES or N/A. If you answered YES or N/A to 145 items, your calculation would look like this:

$$\boxed{145} \text{ divided by } \boxed{148} \text{ multiplied by 100 equals } \boxed{98\%}$$

(items marked YES or N/A) (total survey items) (percent usable)

Your clinic would be 98 percent usable for people with disabilities.

Now enter the total number of yes responses, divide by 148, and multiply by 100 for your score.

$$\boxed{} \div \boxed{148} \times 100 = \boxed{}$$

Appendix C: Mobility Scoring Sheet

Your Mobility Score

To calculate a score for the mobility category, please enter “1” for each item that received a YES or N/A mark next to the corresponding question number below. There are 111 items that count towards the mobility score.

Parking	
1	
2	
3	
4	
5	
6	
7	
Approach to Building	
8	
9	
10	
11	
12	
13	
14	
15	
16	
17	
Ramps	
18	
19	
20	
21	
22	
23	

Controls	
37	
38	
Doors	
39	
40	
41	
42	
43	
44	
45	
46	
Telephone	
47	
48	
49	
Seating	
54	
55	
Counters	
56	
57	
Passageways	
58	
59	
60	
61	

Passageways (continued)	
62	
64	
Water Fountains	
65	
66	
Lifts	
68	
69	
70	
71	
72	
73	
Elevators	
74	
78	
79	
80	
81	
85	
86	
Stairs	
91	
Rest Rooms	
95	
96	
97	
98	
99	

Rest Rooms (continued)	
100	
101	
102	
103	
104	
105	
106	
107	
108	
109	
110	
111	
112	
113	
114	
115	
116	
117	
118	
119	
Emergency Egress	
120	
121	
122	
125	
127	
128	
Mammography Exam Room and Access to Services	
129	

Exam Room (continued)	
130	
132	
133	
Accessible Exam Table	
134	
135	
136	
Accessible Dressing Room	
137	
138	
139	

Dressing Room (continued)	
140	
141	
142	
143	
Accessible Mammography Machine	
144	
145	
146	
147	
148	
Total items	111

How to calculate your mobility score

Example:

Count how many items you marked YES or N/A. If you answered YES or N/A to 108 items, your calculation would look like this:

105

divided by

111

multiplied by 100 equals

94%

(items marked
YES or N/A)

(total survey items)

(percent usable)

Your clinic would be 96 percent usable for people with mobility impairments.

Now enter the total number of yes responses, divide by 111, and multiply by 100 for your score.

÷

111

× 100 =

Appendix D: Sensory Scoring Sheet

Your Sensory Score

To calculate a score for the sensory category, please enter "1" for each item that received a YES or N/A mark next to the corresponding question number below. There are 39 items that count towards the sensory score.

Signage	
24	
25	
26	
27	
28	
29	
30	
31	
32	
33	
34	
35	
36	
Telephone	
50	
51	
52	
53	
Passageways	
63	
Water Fountains	
67	
Elevators	
74	
75	
76	

Elevators (continued)	
77	
78	
80	
82	
83	
84	
Stairs	
87	
88	
89	
90	
Rest Rooms	
92	
93	
94	
Emergency Egress	
123	
124	
125	
126	
Total items:	39

How to calculate your sensory score

Example:

Count how many items you marked YES or N/A. If you answered YES or N/A to 37 items, your calculation would look like this:

$$\begin{array}{ccc} \boxed{35} & \text{divided by} & \boxed{39} & \text{multiplied by 100 equals} & \boxed{92\%} \\ \text{(items marked YES or N/A)} & & \text{(total survey items)} & & \text{(percent usable)} \end{array}$$

Your clinic would be 95 percent usable for people with sensory impairments.

Now enter the total number of yes responses, divide by 39, and multiply by 100 for your score.

$$\boxed{} \div \boxed{39} \times 100 = \boxed{}$$

Appendix E: Cognitive Scoring Sheet

Your Cognitive Score

To calculate a score for the cognitive category, please enter “1” for each item that received a YES or N/A mark next to the corresponding question number below. There are 8 items that count towards the cognitive score.

Signage	
24	
25	
26	
Elevators	
80	
Emergency Egress	
123	
124	
125	
Access to Mammography Exam Room and Services	
131	
Total items	8

How to calculate your cognitive score

Example:

Count how many items you marked YES or N/A. If you answered YES or N/A to 6 items, your calculation would look like this:

7

divided by

8

multiplied by 100 equals

88%

(items marked
YES or N/A)

(total survey items)

(percent usable)

Your clinic would be 88 percent usable for people with cognitive impairments.

Now enter the total number of yes responses, divide by 8, and multiply by 100 for your score.

÷

8

× 100 =

*This publication is
available in
alternate formats
upon request.*

We're on the web!
www.healthwellness.org
